



825 NE Multnomah, Suite 600  
Portland, Oregon 97232

June 16, 2009

Four Corners Windfarm, LLC  
c/o John Deere Renewables, LLC  
Attn: Rick Free  
6400 NW 86<sup>th</sup>  
Johnston, Iowa 50131

Dear Mr. Free,

Enclosed for your signature are two partially executed originals of the Power Purchase Agreement (PPA) for the Four Corners Windfarm. This PPA concerns purchase of all net output from this 10MW project for a twenty (20) year term.

During our final internal review, we discovered a potentially confusing gap in the price table on page 5 of PacifiCorp's Schedule 37 tariff, which provides the published Contract Prices for each year of the PPA. Therefore, we have prepared and signed an Addendum R, which clearly sets forth the Contract Price for each year of the PPA.

If you agree to the terms and conditions of the PPA please execute each of the documents where indicated, retaining one original for your files. Your signature is required on page 31, Exhibit F, and on Addendum R. Also, please initial and date Exhibit C, Addendum A, and Addendum L next to Terry Kramer's signature to indicate that you agree to the terms thereof as of the date and time you execute the PPA, and that you understand that these are thereby executed as of, and fully incorporated by reference into, the PPA itself as of the date of the PPA's execution.. Please return one original, fully executed PPA and a copy of this letter to this office at:

PacifiCorp  
Attn: John Younie  
825 NE Multnomah, Suite 600  
Portland, OR 97232

PacifiCorp understands and intends that the enclosed PPA, PPA Exhibits, Addendum A, Addendum L, and Addendum R are all part of one agreement with Four Corners Windfarm. In the future, references to the "Agreement" or the "PPA" shall refer to all of the aforementioned documents, unless the Parties agree otherwise. Please signal Four Corners Windfarm's concurrence with PacifiCorp's understanding and intent, by signing in the space provided below and returning this letter with the PPA.

Mr. Rick Free  
June 15, 2009  
Page 2 of 2

Please call me at (503) 813-5960 if you should have any questions regarding the PPA.

Sincerely,



Bruce Griswold  
Director, Short Term Origination  
and QF Contracts

Acknowledged and agreed to by  
Four Corners Windfarm, LLC

Richard S. Free as Manager  
Signature

RICHARD S. FREE  
Name

MANAGER  
Title

June 16, 2009  
Date

**POWER PURCHASE AGREEMENT**

**BETWEEN**

**FOUR CORNERS WINDFARM, LLC**

**[a new Firm Qualifying Facility with 10,000 kW Facility Capacity Rating, or Less and an Intermittent Resource with Mechanical Availability Guarantee]**

**AND**

**PACIFICORP**

Section 1: Definitions.....	2
Section 2: Term; Commercial Operation Date.....	8
Section 3: Representations and Warranties.....	8
Section 4: Delivery of Power and Performance Guarantee.....	12
Section 5: Purchase Prices.....	13
Section 6: Operation and Control.....	14
Section 7: Fuel/Motive Force.....	15
Section 8: Metering.....	16
Section 9: Billings, Computations, and Payments.....	17
Section 10: Security.....	18
Section 11: Defaults and Remedies.....	21
Section 12: Indemnification and Liability.....	25
Section 13: Insurance ( <i>Facilities over 200kW only</i> ).....	26
Section 14: Force Majeure.....	27
Section 15: Several Obligations.....	28
Section 16: Choice of Law.....	28
Section 17: Partial Invalidity.....	28
Section 18: Waiver.....	29
Section 19: Governmental Jurisdictions and Authorizations.....	29
Section 20: Repeal of PURPA.....	29
Section 21: Successors and Assigns.....	29
Section 22: Entire Agreement.....	29
Section 23: Notices.....	30

## POWER PURCHASE AGREEMENT

THIS POWER PURCHASE AGREEMENT, entered into on **June 16, 2009** is between Four Corners Windfarm, LLC, "**Seller**" and PacifiCorp (d/b/a Pacific Power & Light Company), an Oregon corporation acting in its regulated utility capacity, "**PacifiCorp**." (Seller and PacifiCorp are referred to individually as a "**Party**" or collectively as the "**Parties**").

### RECITALS

A. Seller intends to construct, own, operate and maintain a wind facility for the generation of electric power, including interconnection facilities, located in Umatilla County, Oregon with a Facility Capacity Rating of 10,000-kilowatts (kW) as further described in **Exhibit A** and **Exhibit B** ("**Facility**"); and

B. Seller intends to commence delivery of Net Output under this Agreement, for the purpose of Start-up Testing, on **July 1, 2009** ("**Scheduled Initial Delivery Date**"); and

C. Seller intends to operate the Facility as a Qualifying Facility, commencing commercial operations on **September 30, 2009** ("**Scheduled Commercial Operation Date**"); and

D. Seller estimates that the average annual Net Energy to be delivered by the Facility to PacifiCorp is 27,707,000 kilowatt-hours (kWh), which amount of energy PacifiCorp will include in its resource planning; and

E. Seller shall (choose one) [**X**] sell all Net Output to PacifiCorp and purchase its full electric requirements from PacifiCorp [ ] sell Net Output surplus to its needs at the Facility site to PacifiCorp and purchase partial electric requirements service from PacifiCorp, in accordance with the terms and conditions of this Agreement; and

F. This Agreement is a "New QF Contract" under the PacifiCorp Inter-Jurisdictional Cost Allocation Revised Protocol.

## AGREEMENT

NOW, THEREFORE, the Parties mutually agree as follows:

### SECTION 1: DEFINITIONS

When used in this Agreement, the following terms shall have the following meanings:

1.1 **"As-built Supplement"** shall be a supplement to **Exhibit A** and **Exhibit B**, provided by Seller following completion of construction of the Facility, describing the Facility as actually built.

1.2 **"Availability"** means the percentage of time that the Facility is capable of producing Net Energy during a Contract Year. The percentage of time during a Contract Year that the Facility is available to produce power is calculated as follows:

$$\% \text{ Availability} = \{[(H \times N) - (\text{Sum of Downtime Hrs for } N \text{ Turbines})] / (H \times N)\} \times 100\%$$

where H is the number of hours in the Contract Year and N is the number of turbines comprising the Facility. Downtime Hours (calculated in 10 minute increments), for each individual unit includes minutes in which the unit is not in "run" status, or is in "run" status but faulted (including any delay in resetting a fault). Notwithstanding the previous sentence, Downtime Hours does not include minutes that a unit is unavailable due to (i) an event of Force Majeure; (ii) a default by PacifiCorp under this Agreement; (iii) Lack of Motive Force at times when the Facility would otherwise be available (including the normal amount of time required by the generating equipment to resume operations following a Lack of Motive Force); or (iv) outages scheduled at least 90 days in advance with PacifiCorp's written consent, up to 240 hours per unit per year.

1.3 **"Average Annual Generation"** shall have the meaning set forth in Section 4.2.

1.4 **"Billing Period"** means, unless otherwise agreed to, the time period between PacifiCorp's consecutive readings of its power purchase billing meter at the Facility in the normal course of PacifiCorp's business. Such periods typically range between twenty-seven (27) and thirty-four (34) days and may not coincide with calendar months.

1.5 **"Commercial Operation Date"** means the date that the Facility is deemed by PacifiCorp to be fully operational and reliable, which shall require, among other things, that all of the following events have occurred:

- 1.5.1 PacifiCorp has received a certificate addressed to PacifiCorp from a Licensed Professional Engineer stating (a) the Facility Capacity Rating of the Facility at the anticipated Commercial Operation Date; and (b) that the Facility is able to generate electric power reliably in amounts required by this Agreement and in accordance with all other terms and conditions of this Agreement;
- 1.5.2 The Facility has completed Start-Up Testing;
- 1.5.3 PacifiCorp has received a certificate addressed to PacifiCorp from a Licensed Professional Engineer stating that, (a), in accordance with the Generation Interconnection Agreement, all required interconnection facilities and metering have been constructed, all required interconnection tests have been completed and the Facility is physically interconnected with PacifiCorp's electric system, and (b) if the Facility consists of multiple wind generation facilities on a common transmission line, the required metering equipment has been completed and tested in conformance with Section 8 of this Agreement (or if the Facility is interconnected with another electric utility that will wheel Net Output to PacifiCorp, all required interconnection facilities have been completed and tested and are in place to allow for such wheeling);
- 1.5.4 PacifiCorp has received a certificate addressed to PacifiCorp from an attorney in good standing in the State of Oregon stating that Seller has obtained all Required Facility Documents and if requested by PacifiCorp, in writing, has provided copies of any or all such requested Required Facility Documents. (Facilities over 200 kW only).
- 1.5.5 Seller has complied with the security requirements of Section 10.
- 1.5.6 PacifiCorp has received an executed copy of **Exhibit F**--Seller's Authorization to Release Generation Data to PacifiCorp.
- 1.6 **"Commission"** means the Oregon Public Utilities Commission.
- 1.7 **"Contract Price"** means the applicable price for capacity or energy, or both capacity and energy, stated in Sections 5.1 and 5.2.

1.8 "**Contract Year**" means a twelve (12) month period commencing at 00:00 hours Pacific Prevailing Time ("PPT") on January 1 and ending on 24:00 hours PPT on December 31; *provided, however*, that the first Contract Year shall commence on the Commercial Operation Date and end on the next succeeding December 31, and the last Contract Year shall end on the Termination Date.

1.9 "**Credit Requirements**" means a long-term credit rating (corporate or long-term senior unsecured debt) of (1) "Baa3" or greater by Moody's, or (2) "BBB-" or greater by S&P, or such other indicia of creditworthiness acceptable to PacifiCorp in its reasonable judgment.

1.10 "**Cut-in Speed**" means the wind speed at which a stationary wind turbine begins producing Net Energy, as specified by the turbine manufacturer, and set forth in **Exhibit A**.

1.11 "**Default Security**", unless otherwise agreed to by the Parties in writing, means the amount of either a Letter of Credit or cash placed in an escrow account sufficient to replace twelve (12) average months of replacement power costs over the term of this Agreement, and shall be calculated by taking the average, over the term of this Agreement, of the positive difference between (a) the monthly forward power prices at Mid-Columbia (Mid-C) (as determined by PacifiCorp in good faith using information from a commercially reasonable independent source), multiplied by 110%, minus (b) the average of the Fixed Avoided Cost Prices specified in Schedule 37, and multiplying such difference by (c) 25% of the Average Annual Generation provided, however, the amount of Default Security shall in no event be less than the amount equal to the payments PacifiCorp would make for three (3) average months based on Seller's average monthly volume over the term of this Agreement and utilizing the average Fixed Avoided Cost Prices specified in Schedule 37. Such amount shall be fixed at the Effective Date of this Agreement.

1.12 "**Effective Date**" shall have the meaning set forth in Section 2.1.

1.13 "**Energy Delivery Schedule**" shall have the meaning set forth in Section 4.4.

1.14 "**Environmental Attributes**" shall have the meaning set forth in Section 5.5.

1.15 "**Excess Output**" shall mean any increment of Net Output delivered at a rate, on an hourly basis, exceeding the Facility Capacity Rating.

1.16 "**Facility**" shall have the meaning set forth in Recital A.

1.17 "**Facility Capacity Rating**" means the sum of the Nameplate Capacity Ratings for all generators comprising the Facility.

1.18 **"FERC"** means the Federal Energy Regulatory Commission, or its successor.

1.19 **"Guaranteed Availability"** shall have the meaning set forth in Section 4.3.1.

1.20 **"Generation Interconnection Agreement"** means the generation interconnection agreement to be entered into separately between Seller and PacifiCorp's transmission or distribution department, as applicable, providing for the construction, operation, and maintenance of PacifiCorp's interconnection facilities required to accommodate deliveries of Seller's Net Output if the Facility is to be interconnected directly with PacifiCorp rather than another electric utility.

1.21 **"Lack of Motive Force"** means temporary lack, due to natural causes, of: sunlight (for a solar powered facility), water (for a hydropower facility), current or wave amplitude (for a wave energy facility), or Sufficient Wind (for a wind turbine facility). Lack of Motive Force does not include lack of any motive force due to voluntary actions taken by Seller (e.g. lease or sale of water rights).

1.22 **"Letter of Credit"** means an irrevocable standby letter of credit, from an institution that has a long-term senior unsecured debt rating of "A" or greater from S&P or "A2" or greater from Moody's, in a form reasonably acceptable to PacifiCorp, naming PacifiCorp as the party entitled to demand payment and present draw requests thereunder.

1.23 **"Licensed Professional Engineer"** means a person acceptable to PacifiCorp in its reasonable judgment who is licensed to practice engineering in the state of Oregon, who has no economic relationship, association, or nexus with the Seller, and who is not a representative of a consulting engineer, contractor, designer or other individual involved in the development of the Facility, or of a manufacturer or supplier of any equipment installed in the Facility. Such Licensed Professional Engineer shall be licensed in an appropriate engineering discipline for the required certification being made.

1.24 **"Material Adverse Change"** means the occurrence of any event of default under any material agreement to which Seller is a party and of any other development, financial or otherwise, which would have a material adverse effect on Seller, the Facility or Seller's ability to develop, construct, operate, maintain or own the Facility as provided in this Agreement

1.25 **"Nameplate Capacity Rating"** means the full-load electrical quantities assigned by the designer to a generator and its prime mover or other piece of electrical equipment, such as transformers and circuit breakers, under standardized conditions, expressed in amperes, kilovoltamperes, kilowatts, volts, or other appropriate units. Usually indicated on a nameplate attached to the individual machine or device.



1.26 "**Net Energy**" means the energy component, in kWh, of Net Output.

1.27 "**Net Output**" means all energy and capacity produced by the Facility, less station use and less transformation and transmission losses and other adjustments (e.g., Seller's load other than station use), if any. For purposes of calculating payment under this Agreement, Net Output of energy shall be the amount of energy flowing through the Point of Delivery.

1.28 "**Net Replacement Power Costs**" shall have the meaning set forth in Section 11.4.1.

1.29 "**Off-Peak Hours**" means all hours of the week that are not On-Peak Hours.

1.30 "**On-Peak Hours**" means the hours between 6 a.m. Pacific Prevailing Time ("**PPT**") and 10 p.m. PPT, Mondays through Saturdays, excluding all hours occurring on holidays as provided in Schedule 37.

1.31 "**Output Shortfall**" shall have the meaning set forth in Section 4.3.2.

1.32 "**Point of Delivery**" means the high side of the Seller's step-up transformer(s) located at the point of interconnection between the Facility and PacifiCorp's distribution/transmission system, as specified in the Generation Interconnection Agreement, or, if the Facility is not interconnected directly with PacifiCorp, the point at which another utility will deliver the Net Output to PacifiCorp as specified in **Exhibit B**.

1.33 "**Prime Rate**" means the publicly announced prime rate for commercial loans to large businesses with the highest credit rating in the United States in effect from time to time quoted by Citibank, N.A. If a Citibank, N.A. prime rate is not available, the applicable Prime Rate shall be the announced prime rate for commercial loans in effect from time to time quoted by a bank with \$10 billion or more in assets in New York City, New York, selected by the Party to whom interest based on the Prime Rate is being paid.

1.34 "**Prudent Electrical Practices**" means any of the practices, methods and acts engaged in or approved by a significant portion of the electrical utility industry or any of the practices, methods or acts, which, in the exercise of reasonable judgment in the light of the facts known at the time a decision is made, could have been expected to accomplish the desired result at the lowest reasonable cost consistent with reliability, safety and expedition. Prudent Electrical Practices is not intended to be limited to the optimum practice, method or act to the exclusion of all others, but rather to be a spectrum of possible practices, methods or acts.

1.35 "QF" means "Qualifying Facility," as that term is defined in the FERC regulations (codified at 18 CFR Part 292) in effect on the Effective Date.

1.36 "Replacement Price" means the price at which PacifiCorp, acting in a commercially reasonable manner, purchases for delivery at the Point of Delivery a replacement for any Net Output that Seller is required to deliver under this Agreement plus (i) costs reasonably incurred by PacifiCorp in purchasing such replacement Net Output, and (ii) additional transmission charges, if any, reasonably incurred by PacifiCorp in causing replacement energy to be delivered to the Point of Delivery. If PacifiCorp elects not to make such a purchase, the Replacement Price shall be the market price at the Mid-Columbia trading hub for such energy not delivered, plus any additional cost or expense incurred as a result of Seller's failure to deliver, as determined by PacifiCorp in a commercially reasonable manner (but not including any penalties, ratcheted demand or similar charges).

1.37 "Required Facility Documents" means all licenses, permits, authorizations, and agreements, including a Generation Interconnection Agreement or equivalent, necessary for construction, operation, and maintenance of the Facility consistent with the terms of this Agreement, including without limitation those set forth in **Exhibit C**.

1.38 "Schedule 37" means the Schedule 37 of Pacific Power & Light Company's Commission-approved tariffs, providing pricing options for Qualifying Facilities of 10,000 kW or less, which is in effect on the Effective Date of this Agreement. A copy of that Schedule 37 is attached as **Exhibit G**.

1.39 "Scheduled Commercial Operation Date" shall have the meaning set forth in Recital C.

1.40 "Scheduled Initial Delivery Date" shall have the meaning set forth in Recital B.

1.41 "Start-Up Testing" means the completion of required factory and start-up tests as set forth in **Exhibit E** hereto.

1.42 "Sufficient Wind" means any hour during which the average wind speed is equal to or greater than the manufacturer's rated Cut-in Speed for the wind turbines comprising the Facility.

1.43 "Termination Date" shall have the meaning set forth in Section 2.4.

## SECTION 2: TERM; COMMERCIAL OPERATION DATE

2.1 This Agreement shall become effective after execution by both Parties ("**Effective Date**").

2.2 **Time is of the essence for this Agreement**, and Seller's ability to meet certain requirements prior to the Commercial Operation Date and to deliver Net Output by the Scheduled Commercial Operation Date is critically important. Therefore,

2.2.1 By **May 29, 2009**, Seller shall provide PacifiCorp with a copy of an executed Generation Interconnection Agreement, or wheeling agreement, as applicable, which shall be consistent with all material terms and requirements of this Agreement.

2.2.2 Upon completion of construction, Seller, in accordance with Section 6.1, shall provide PacifiCorp with an As-built Supplement acceptable to PacifiCorp;

2.2.3 By the date thirty (30) days after the Effective Date, Seller shall provide Default Security required under Sections 10.1 or 10.2, as applicable.

2.3 Seller shall cause the Facility to achieve Commercial Operation on or before the Scheduled Commercial Operation Date. If Commercial Operation occurs after the Scheduled Commercial Operation Date, Seller shall be in default, and liable for delay damages specified in Section 11.

2.4 Except as otherwise provided herein, this Agreement shall terminate on **June 30, 2029** ("**Termination Date**").

## SECTION 3: REPRESENTATIONS AND WARRANTIES

3.1 PacifiCorp represents, covenants, and warrants to Seller that:

3.1.1 PacifiCorp is duly organized and validly existing under the laws of the State of Oregon.

- 3.1.2 PacifiCorp has the requisite corporate power and authority to enter into this Agreement and to perform according to the terms of this Agreement.
  - 3.1.3 PacifiCorp has taken all corporate actions required to be taken by it to authorize the execution, delivery and performance of this Agreement and the consummation of the transactions contemplated hereby.
  - 3.1.4 The execution and delivery of this Agreement does not contravene any provision of, or constitute a default under, any indenture, mortgage, or other material agreement binding on PacifiCorp or any valid order of any court, or any regulatory agency or other body having authority to which PacifiCorp is subject.
  - 3.1.5 This Agreement is a valid and legally binding obligation of PacifiCorp, enforceable against PacifiCorp in accordance with its terms (except as the enforceability of this Agreement may be limited by bankruptcy, insolvency, bank moratorium or similar laws affecting creditors' rights generally and laws restricting the availability of equitable remedies and except as the enforceability of this Agreement may be subject to general principles of equity, whether or not such enforceability is considered in a proceeding at equity or in law).
- 3.2 Seller represents, covenants, and warrants to PacifiCorp that:
- 3.2.1 Seller is a Limited Liability Company duly organized and validly existing under the laws of Oregon.
  - 3.2.2 Seller has the requisite power and authority to enter into this Agreement and to perform according to the terms hereof, including all required regulatory authority to make wholesale sales from the Facility.
  - 3.2.3 Seller has taken all actions required to authorize the execution, delivery and performance of this Agreement and the consummation of the transactions contemplated hereby.
  - 3.2.4 The execution and delivery of this Agreement does not contravene any provision of, or constitute a default under, any indenture, mortgage, or other material agreement binding on Seller or any valid order of any court, or any regulatory agency or other body having authority to which Seller is subject.

- 3.2.5 This Agreement is a valid and legally binding obligation of Seller, enforceable against Seller in accordance with its terms (except as the enforceability of this Agreement may be limited by bankruptcy, insolvency, bank moratorium or similar laws affecting creditors' rights generally and laws restricting the availability of equitable remedies and except as the enforceability of this Agreement may be subject to general principles of equity, whether or not such enforceability is considered in a proceeding at equity or in law).
- 3.2.6 The Facility is and shall for the term of this Agreement continue to be a QF, and Seller will operate the Facility in a manner consistent with its FERC QF certification. Seller has provided to PacifiCorp the appropriate QF certification (which may include a FERC self-certification) prior to PacifiCorp's execution of this Agreement. At any time during the term of this Agreement, PacifiCorp may require Seller to provide PacifiCorp with evidence satisfactory to PacifiCorp in its reasonable discretion that the Facility continues to qualify as a QF under all applicable requirements and, if PacifiCorp is not satisfied that the Facility qualifies for such status, a written legal opinion from an attorney who is (a) in good standing in the state of Oregon, and (b) who has no economic relationship, association or nexus with the Seller or the Facility, stating that the Facility is a QF and providing sufficient proof (including copies of all documents and data as PacifiCorp may request) demonstrating that Seller has maintained and will continue to maintain the Facility as a QF.
- 3.2.7 Compliance with Partial Stipulation in Commission Proceeding No. UM-1129. Seller will not make any changes in its ownership, control, or management during the term of this Agreement that would cause it to not be in compliance with the definition of a Small Cogeneration Facility or Small Power Production Facility provided in PacifiCorp's Schedule 37 tariff approved by the Commission at the time this Agreement is executed. Seller will provide, upon request by PacifiCorp not more frequently than every 36 months, such documentation and information as reasonably may be required to establish Seller's continued compliance with such Definition. PacifiCorp agrees to take reasonable steps to maintain the confidentiality of any portion of the above-described documentation and information that the Seller identifies as confidential except PacifiCorp will provide all such confidential information the Public Utility Commission of Oregon upon the Commission's request.
- 3.2.8 Additional Seller Creditworthiness Warranties. Seller need not post security under Section 10 for PacifiCorp's benefit in the event of Seller default, provided that Seller warrants all of the following:

- (a) Neither the Seller nor any of its principal equity owners is or has within the past two (2) years been the debtor in any bankruptcy proceeding, is unable to pay its bills in the ordinary course of its business, or is the subject of any legal or regulatory action, the result of which could reasonably be expected to impair Seller's ability to own and operate the Facility in accordance with the terms of this Agreement.
- (b) Seller has not at any time defaulted in any of its payment obligations for electricity purchased from PacifiCorp.
- (c) Seller is not in default under any of its other agreements and is current on all of its financial obligations, including construction related financial obligations.
- (d) Seller owns, and will continue to own for the term of this Agreement, all right, title and interest in and to the Facility, free and clear of all liens and encumbrances other than liens and encumbrances related to third-party financing of the Facility.
- (e) **[Applicable only to Seller's with a Facility having a Facility Capacity Rating greater than 3,000 kW]** Seller meets the Credit Requirements.

Seller hereby declares (Seller initial one only):

Seller affirms and adopts all warranties of this Section 3.2.8, and therefore is not required to post security under Section 10; or

X Seller does not affirm and adopt all warranties of this Section 3.2.8, and therefore Seller elects to post the security specified in Section 10.

3.3 Notice. If at any time during this Agreement, any Party obtains actual knowledge of any event or information which would have caused any of the representations and warranties in this Section 3 to have been materially untrue or misleading when made, such Party shall provide the other Party with written notice of the event or information, the representations and warranties affected, and the action, if any, which such Party intends to take to make the representations and warranties true and correct. The notice required pursuant to this Section shall be given as soon as practicable after the occurrence of each such event.

## SECTION 4: DELIVERY OF POWER AND PERFORMANCE GUARANTEE

4.1 Commencing on the Commercial Operation Date, unless otherwise provided herein, Seller will sell and PacifiCorp will purchase all Net Output from the Facility delivered to the Point of Delivery.

4.2 Average Annual Generation. Seller estimates that the Facility will generate, on average, 27,707,000 kWh per Contract Year ("**Average Annual Generation**"). Seller may, upon at least six months prior written notice, modify the Average Annual Generation every other Contract Year.

4.3 Performance Guaranty.

4.3.1 Guaranteed Availability. Seller guarantees that the annual Availability of the Facility (the "**Guaranteed Availability**") for (i) the first Contract Year shall be no less than 0.80, and (ii) for the second Contract Year shall be no less than 0.85. Beginning with the third Contract Year and for each Contract Year thereafter, the Guaranteed Availability for each Contract Year shall be 0.875, with such annual Availability to be calculated for purposes of this Section 4.3.1 for each Contract Year.

4.3.2 Liquidated Damages for Output Shortfall. If the Availability in any given Contract Year falls below the Guaranteed Availability for that Contract Year, the resulting shortfall shall be expressed in kWh as the "**Output Shortfall**." The Output Shortfall shall be calculated in accordance with the following formula:

$$\text{Output Shortfall} = (\text{Guaranteed Availability} - \text{Availability}) \times \text{Average Annual Generation}$$

If an Output Shortfall occurs in any given Contract Year, Seller may owe PacifiCorp liquidated damages in accordance with Section 11. Each Party agrees and acknowledges that (a) the damages that PacifiCorp would incur due to the Facility's failure to achieve the Guaranteed Availability would be difficult or impossible to predict with certainty, and (b) the liquidated damages contemplated by Section 11 are a fair and reasonable calculation of such damages.

4.4 Energy Delivery Schedule. Seller has provided a monthly schedule of Net Energy expected to be delivered by the Facility ("**Energy Delivery Schedule**"), incorporated into **Exhibit D-1**.

#### SECTION 5: PURCHASE PRICES

5.1 Seller shall have the option to select one of four pricing options: Fixed Avoided Cost Prices ("Fixed Price"), Firm Market Indexed Avoided Cost Prices ("Firm Electric Market"), Gas Market Indexed Avoided Cost Prices ("Gas Market"), or Banded Gas Market Indexed Avoided Cost Prices ("Banded Gas Market"), as published in Schedule 37. Once an option is selected the option will remain in effect for the duration of the Facility's contract. Seller has selected the following (Seller to initial one):

- Fixed Price
- Firm Electric Market
- Gas Market
- Banded Gas Market

A copy of Schedule 37, and a table summarizing the purchase prices under the pricing option selected by Seller, is attached as **Exhibit G**.

5.2 (Fixed Price Sellers Only). In the event Seller elects the Fixed Price payment method, PacifiCorp shall pay Seller the applicable On-Peak and Off-Peak rates specified in **Schedule 37** during the first fifteen (15) years after the Scheduled Initial Delivery Date. Thereafter, PacifiCorp shall pay Seller market-based rates, using the following pricing option (Seller to initial one):

- Firm Electric Market
- Gas Market
- Banded Gas Market

5.3 If the Seller elects a gas market indexed price option, the index shall be the Opal Gas Market Index as provided in Schedule 37. In the event that Platt ceases to publish the Opal Gas Market Index, the Company shall replace the index with a similar gas index.



5.4 For all Excess Output and for all Net Output delivered prior to the Commercial Operation Date, PacifiCorp shall pay Seller a blended market index price for day-ahead non-firm energy at Mid-Columbia, California Oregon Border (COB), Four Corners and Palo Verde market indices as reported by Dow Jones, for the On-Peak and Off-Peak periods. PacifiCorp shall document its calculation of the blended rate, upon request, to Seller. Such payment will be accomplished by adjustments pursuant to Section 9.2.

5.5 Environmental Attributes. PacifiCorp waives any claim to Seller's ownership of Environmental Attributes under this Agreement. Environmental Attributes include, but are not limited to, Green Tags, Green Certificates, Renewable Energy Credits (RECs) and Tradable Renewable Certificates (TRCs) (as those terms are commonly used in the regional electric utility industry) directly associated with the production of energy from the Seller's Facility.

## **SECTION 6: OPERATION AND CONTROL**

6.1 As-Built Supplement. Upon completion of initial (and any subsequent) construction of the Facility, Seller shall provide PacifiCorp an As-built Supplement to specify the actual Facility as built. The As-built Supplement must be reviewed and approved by PacifiCorp, which approval shall not unreasonably be withheld, conditioned or delayed.

6.2 Incremental Utility Upgrades. At start-up (and at any other time upon at least six month's prior written notice), Seller may increase Net Output, if such increase is due to normal variances in estimated versus actual performance, changed Facility operations, or improvements in Facility efficiency. Seller may not increase Net Output under this Agreement by installing additional generating units. In the case of substantial upgrades, PacifiCorp may require Seller to comply with Section 3.2.8(e) (in the event that the Facility upgrade causes the Facility Capacity Rating to exceed 3,000 kW) and increase its Average Annual Generation in Section 4.2 (if appropriate). PacifiCorp may also update Seller's security obligation (if applicable). So long as the Facility Capacity Rating after the upgrade is 10,000 kW or less, Seller will continue to receive the Contract Price for the Net Output, as set forth in Sections 5.1 and 5.2 of this Agreement. If Seller increases the Facility Capacity Rating above 10,000 kW, then (on a going forward basis) PacifiCorp shall pay Seller the Contract Price for the fraction of total Net Output equal to 10,000 kW divided by the Facility Capacity Rating of the upgraded Facility. For the remaining fraction of Net Output, PacifiCorp and Seller shall agree to a new negotiated rate. Seller shall be responsible for ensuring that any planned increase in the Facility Capacity Rating or the maximum instantaneous capacity of the Facility complies with Seller's Generation Interconnection Agreement and any other agreements with PacifiCorp.

6.3 Seller shall operate and maintain the Facility in a safe manner in accordance with the Generation Interconnection Agreement (if applicable), Prudent Electrical Practices and in accordance with the requirements of all applicable federal, state and local laws and the National Electric Safety Code as such laws and code may be amended from time to time. PacifiCorp shall have no obligation to purchase Net Output from the Facility to the extent the interconnection between the Facility and PacifiCorp's electric system is disconnected, suspended or interrupted, in whole or in part, pursuant to the Generation Interconnection Agreement, or to the extent generation curtailment is required as a result of Seller's non-compliance with the Generation Interconnection Agreement. PacifiCorp shall have the right to inspect the Facility to confirm that Seller is operating the Facility in accordance with the provisions of this Section 6.3 upon reasonable notice to Seller. Seller is solely responsible for the operation and maintenance of the Facility. PacifiCorp shall not, by reason of its decision to inspect or not to inspect the Facility, or by any action or inaction taken with respect to any such inspection, assume or be held responsible for any liability or occurrence arising from the operation and maintenance by Seller of the Facility.

6.4 Scheduled Outages. Seller may cease operation of the entire Facility or individual units, if applicable, for maintenance or other purposes. Seller shall exercise its best efforts to notify PacifiCorp of planned outages at least ninety (90) days prior, and shall reasonably accommodate PacifiCorp's request, if any, to reschedule such planned outage in order to accommodate PacifiCorp's need for Facility operation.

6.5 Unplanned Outages. In the event of an unscheduled outage or curtailment exceeding twenty-five (25) percent of the Facility Capacity Rating (other than curtailments due to lack of motive force), Seller immediately shall notify PacifiCorp of the necessity of such unscheduled outage or curtailment, the time when such has occurred or will occur and the anticipated duration. Seller shall take all reasonable measures and exercise its best efforts to avoid unscheduled outage or curtailment, to limit the duration of such, and to perform unscheduled maintenance during Off-Peak hours.

## **SECTION 7: FUEL/MOTIVE FORCE**

Prior to the Effective Date of this Agreement, Seller provided to PacifiCorp a fuel or motive force plan acceptable to PacifiCorp in its reasonable discretion and attached hereto as **Exhibit D-1**, together with a certification from a Licensed Professional Engineer to PacifiCorp attached hereto as **Exhibit D-2**, certifying that the implementation of the fuel or motive force plan can reasonably be expected to provide fuel or motive force to the Facility for the duration of this Agreement adequate to generate power and energy in quantities necessary to deliver the Average Annual Generation set forth by Seller in Section 4.

## SECTION 8: METERING

8.1 Seller shall pay for, and PacifiCorp shall design, furnish, install, own, inspect, test, maintain and replace all metering equipment required pursuant to the Generation Interconnection Agreement, if applicable.

8.2 Seller shall pay for and design, furnish, install, own, inspect, test, maintain and replace all metering equipment required in order to calculate Availability of the Facility. Data required to calculate Availability include, but are not limited to: hourly average wind velocity measured at turbine hub height; and ambient air temperature. Seller shall make available all such data to PacifiCorp in electronic format per Section 8.5.

8.3 Metering shall be performed at the location and in a manner consistent with this Agreement and as specified in the Generation Interconnection Agreement, or, if the Facility is one of multiple wind generation facilities sharing a common transmission line, the required metering equipment has been completed and tested and is in place to correctly and accurately measure the amount of Net Output generated by the Facility and flowing into PacifiCorp's system at the Point of Delivery, or, if the Net Output is to be wheeled to PacifiCorp by another utility, metering will be performed in accordance with the terms of PacifiCorp's interconnection agreement with such other utility. All quantities of energy purchased hereunder shall be adjusted to account for electrical losses, if any between the point of metering and the Point of Delivery, so that the purchased amount reflects the net amount of energy flowing into PacifiCorp's system at the Point of Delivery.

8.4 PacifiCorp shall periodically inspect, test, repair and replace the metering equipment as provided in the Generation Interconnection Agreement, if applicable. If the Net Output is to be wheeled to PacifiCorp by another utility, meter inspection, testing, repair and replacement will be performed in accordance with the terms of PacifiCorp's interconnection agreement with such utility. If any of the inspections or tests discloses an error exceeding two percent (2%), either fast or slow, proper correction, based upon the inaccuracy found, shall be made of previous readings for the actual period during which the metering equipment rendered inaccurate measurements if that period can be ascertained. If the actual period cannot be ascertained, the proper correction shall be made to the measurements taken during the time the metering equipment was in service since last tested, but not exceeding three (3) Billing Periods, in the amount the metering equipment shall have been shown to be in error by such test. Any correction in billings or payments resulting from a correction in the meter records shall be made in the next monthly billing or payment rendered following the repair of the meter.

8.5 Telemetering. In support of PacifiCorp's calculation of Availability, Seller shall pay for and PacifiCorp shall design, furnish, install, own, inspect, test, maintain and replace telemetering equipment capable of transmitting all data required pursuant to Section 8.1 regardless of whether the Facility is directly interconnected to PacifiCorp's system, one of multiple wind generation facilities on a common transmission line, or the Net Output is to be wheeled to PacifiCorp by another utility. Seller shall provide PacifiCorp a location at its Facility for such telemetering equipment, and shall provide PacifiCorp reasonable access thereto.

## **SECTION 9: BILLINGS, COMPUTATIONS, AND PAYMENTS**

9.1 On or before the thirtieth (30th) day following the end of each Billing Period, PacifiCorp shall send to Seller payment for Seller's deliveries of Net Output to PacifiCorp, together with computations supporting such payment. PacifiCorp may offset any such payment to reflect amounts owing from Seller to PacifiCorp pursuant to this Agreement, the Generation Interconnection Agreement, or any other agreement between the Parties.

9.2 Corrections. PacifiCorp shall have up to eighteen months to adjust any payment made pursuant to Section 9.1. In the event PacifiCorp determines it has overpaid Seller (for Excess Output or otherwise), PacifiCorp may adjust Seller's future payment accordingly in order to recapture any overpayment in a reasonable time.

9.3 Annual Invoicing for Output Shortfall. Beginning on the first January 31 occurring after the Commercial Operation Date, and continuing on January 31 of each Contract Year thereafter, PacifiCorp shall deliver to Seller an invoice showing PacifiCorp's computation of Net Output and Output Shortfall, if any, for the prior Contract Year and any resulting amount due PacifiCorp as liquidated damages. In preparing such invoices, PacifiCorp shall utilize the meter data provided to PacifiCorp for the Contract Year in question, but may also rely on historical averages and such other information as may be available to PacifiCorp at the time of invoice preparation, if the meter data for such Contract Year is then incomplete or otherwise not available. To the extent required, PacifiCorp shall true up any such invoice as promptly as practicable following its receipt of actual results for the relevant Contract Year. Seller shall pay to PacifiCorp, by wire transfer or by any other means agreed to by the Parties in writing, the amount set forth as due in such invoice.

9.4 Any amounts owing after the due date thereof shall bear interest at the Prime Rate plus two percent (2%) from the date due until paid; *provided, however*, that the interest rate shall at no time exceed the maximum rate allowed by applicable law.

## SECTION 10: SECURITY

Unless Seller has adopted the creditworthiness warranties contained in Section 3.2.8, Seller must provide security (if requested by PacifiCorp) in the form of a cash escrow, letter of credit, senior lien, or step-in rights. Seller hereby elects to provide, in accordance with the applicable terms of this Section 10, the following security (Seller to initial one selection only):

Cash Escrow

X Letter of Credit (\$511,965)

Senior Lien

Step in Rights

Seller has adopted the Creditworthiness Warranties of Section 3.2.8.

In the event Seller's obligation to post default security (under Section 10 or Section 11.1.4) arises solely from Seller's delinquent performance of construction-related financial obligations, upon Seller's request, PacifiCorp will excuse Seller from such obligation in the event Seller has negotiated financial arrangements with its construction lenders that mitigate Seller's financial risks to PacifiCorp's reasonable satisfaction.

**[SKIP THIS SECTION 10.1 UNLESS SELLER SELECTED CASH ESCROW ALTERNATIVE]**

10.1 Cash Escrow Security. Seller shall deposit in an escrow account established by PacifiCorp in a banking institution acceptable to both Parties, the Default Security. Such sum shall earn interest at the rate applicable to money market deposits at such banking institution from time to time. To the extent PacifiCorp receives payment from the Default Security, Seller shall, within fifteen (15) days, restore the Default Security as if no such deduction had occurred.

**[SKIP THIS SECTION 10.2 UNLESS SELLER SELECTED LETTER OF CREDIT ALTERNATIVE]**

10.2 Letter of Credit Security. Seller shall post and maintain in an amount equal to the Default Security: (a) a guaranty from a party that satisfies the Credit Requirements, in a form acceptable to PacifiCorp in its discretion, or (b) a Letter of Credit in favor of PacifiCorp. To the extent PacifiCorp receives payment from the Default Security, Seller shall, within fifteen (15) days, restore the Default Security as if no such deduction had occurred.

**[SKIP THIS SECTION 10.3 UNLESS SELLER SELECTED SENIOR LIEN ALTERNATIVE]**

10.3 Senior Lien. Before the Scheduled Commercial Operation Date, Seller shall grant PacifiCorp a senior, unsubordinated lien on the Facility and its assets as security for performance of this Agreement by executing, acknowledging and delivering a security agreement and a deed of trust or a mortgage, in a recordable form (each in a form satisfactory to PacifiCorp in the reasonable exercise of its discretion). Pending delivery of the senior lien to PacifiCorp, Seller shall not cause or permit the Facility or its assets to be burdened by liens or other encumbrances that would be superior to PacifiCorp's, other than workers', mechanics', suppliers' or similar liens, or tax liens, in each case arising in the ordinary course of business that are either not yet due and payable or that have been released by means of a performance bond posted within eight (8) calendar days of the commencement of any proceeding to foreclose the lien.

**[SKIP THIS SECTION 10.4 UNLESS SELLER SELECTED STEP-IN RIGHTS ALTERNATIVE]**

10.4 Step-in Rights (Operation by PacifiCorp Following Event of Default of Seller).

10.4.1 Prior to any termination of this Agreement due to an Event of Default of Seller, as identified in Section 11, PacifiCorp shall have the right, but not the obligation, to possess, assume control of, and operate the Facility as agent for Seller (in accordance with Seller's rights, obligations, and interest under this Agreement) during the period provided for herein. Seller shall not grant any person, other than the lending institution providing financing to the Seller for construction of the Facility ("Facility Lender"), a right to possess, assume control of, and operate the Facility that is equal to or superior to PacifiCorp's right under this Section 10.4.

10.4.2 PacifiCorp shall give Seller ten (10) calendar days notice in advance of the contemplated exercise of PacifiCorp's rights under this Section 10.4. Upon such notice, Seller shall collect and have available at a convenient, central location at the Facility all documents, contracts, books, manuals, reports, and records required to construct, operate, and maintain the Facility in accordance with Prudent Electrical Practices. Upon such notice, PacifiCorp, its employees, contractors, or designated third parties shall have the unrestricted right to enter the Facility for the purpose of constructing and/or operating the Facility. Seller hereby irrevocably appoints PacifiCorp as Seller's attorney-in-fact for the exclusive purpose of executing such documents and taking such other actions as PacifiCorp may reasonably deem necessary or appropriate to exercise PacifiCorp's step-in rights under this Section 10.4.

10.4.3 During any period that PacifiCorp is in possession of and constructing and/or operating the Facility, no proceeds or other monies attributed to operation of the Facility shall be remitted to or otherwise provided to the account of Seller until all Events of Default of Seller have been cured.

10.4.4 During any period that PacifiCorp is in possession of and operating the Facility, Seller shall retain legal title to and ownership of the Facility and PacifiCorp shall assume possession, operation, and control solely as agent for Seller.

(a) In the event PacifiCorp is in possession and control of the Facility for an interim period, Seller shall resume operation and PacifiCorp shall relinquish its right to operate when Seller demonstrates to PacifiCorp's reasonable satisfaction that it will remove those grounds that originally gave rise to PacifiCorp's right to operate the Facility, as provided above, in that Seller (i) will resume operation of the Facility in accordance with the provisions of this Agreement, and (ii) has cured any Events of Default of Seller which allowed PacifiCorp to exercise its rights under this Section 10.4.

(b) In the event that PacifiCorp is in possession and control of the Facility for an interim period, the Facility Lender, or any nominee or transferee thereof, may foreclose and take possession of and operate the Facility and PacifiCorp shall relinquish its right to operate when the Facility Lender or any nominee or transferee thereof, requests such relinquishment.

10.4.5 PacifiCorp's exercise of its rights hereunder to possess and operate the Facility shall not be deemed an assumption by PacifiCorp of any liability attributable to Seller. If at any time after exercising its rights to take possession of and operate the Facility PacifiCorp elects to return such possession and operation to Seller, PacifiCorp shall provide Seller with at least fifteen (15) calendar days advance notice of the date PacifiCorp intends to return such possession and operation, and upon receipt of such notice Seller shall take all measures necessary to resume possession and operation of the Facility on such date.

### **SECTION 11: DEFAULTS AND REMEDIES**

11.1 Events of Default. The following events shall constitute defaults under this Agreement:

11.1.1 Breach of Material Term. Failure of a Party to perform any material obligation imposed upon that Party by this Agreement (including but not limited to failure by Seller to meet any deadline set forth in Section 2) or breach by a Party of a representation or warranty set forth in this Agreement.

11.1.2 Default on Other Agreements. Seller's failure to cure any default under any commercial or financing agreements or instrument (including the Generation Interconnection Agreement) within the time allowed for a cure under such agreement or instrument.

11.1.3 Insolvency. A Party (a) makes an assignment for the benefit of its creditors; (b) files a petition or otherwise commences, authorizes or acquiesces in the commencement of a proceeding or cause of action under any bankruptcy or similar law for the protection of creditors, or has such a petition filed against it and such petition is not withdrawn or dismissed within sixty (60) days after such filing; (c) becomes insolvent; or (d) is unable to pay its debts when due.

11.1.4 Material Adverse Change. A Material Adverse Change has occurred with respect to Seller and Seller fails to provide such performance assurances as are reasonably requested by PacifiCorp, including without limitation the posting of additional Default Security, within thirty (30) days from the date of such request;



11.1.5 Delayed Commercial Operations. Seller's failure to achieve the Commercial Operation Date by the Scheduled Commercial Operation Date.

11.1.6 Underdelivery. If Seller's Facility has a Facility Capacity Rating of 100 kW or less, Seller's failure to satisfy an Availability of fifty percent (50%) or more for two (2) consecutive years; else Seller's failure to satisfy an Availability of fifty percent (50%) or more for one year.

11.2 Notice; Opportunity to Cure.

11.2.1 Notice. In the event of any default hereunder, the non-defaulting Party must notify the defaulting Party in writing of the circumstances indicating the default and outlining the requirements to cure the default.

11.2.2 Opportunity to Cure. A Party defaulting under Section 11.1.1 or 11.1.5 shall have thirty (30) days to cure after receipt of proper notice from the non-defaulting Party. This thirty (30) day period shall be extended by an additional ninety (90) days if (a) the failure cannot reasonably be cured within the thirty (30) day period despite diligent efforts, (b) the default is capable of being cured within the additional ninety (90) day period, and (c) the defaulting Party commences the cure within the original thirty (30) day period and is at all times thereafter diligently and continuously proceeding to cure the failure.

11.2.3 Seller Default Under Other Agreements. Seller shall cause any notices of default under any of its commercial or financing agreements or instruments to be sent by the other party to such agreements or instruments, or immediately forwarded, to PacifiCorp as a notice in accordance with Section 23.

11.2.4 Seller Delinquent on Construction-related Financial Obligations. Seller promptly shall notify PacifiCorp (or cause PacifiCorp to be notified) anytime it becomes delinquent under any construction related financing agreement or instrument related to the Facility. Such delinquency may constitute a Material Adverse Change, subject to Section 11.1.4.

### 11.3 Termination.

- 11.3.1 Notice of Termination. If a default described herein has not been cured within the prescribed time, above, the non-defaulting Party may terminate this Agreement at its sole discretion by delivering written notice to the other Party and may pursue any and all legal or equitable remedies provided by law or pursuant to this Agreement; *provided, however* that PacifiCorp shall not terminate: (a) for a default under Section 11.1.5 unless PacifiCorp is in a resource deficient state during the period Commercial Operation is delayed; or (b) for a default under Section 11.1.6, unless such default is material. The rights provided in Section 10 and this Section 11 are cumulative such that the exercise of one or more rights shall not constitute a waiver of any other rights. Further, the Parties may by mutual written agreement amend this Agreement in lieu of a Party's exercise of its right to terminate.
- 11.3.2 In the event this Agreement is terminated because of Seller's default and Seller wishes to again sell Net Output to PacifiCorp following such termination, PacifiCorp in its sole discretion may require that Seller shall do so subject to the terms of this Agreement, including but not limited to the Contract Price, until the Termination Date (as set forth in Section 2.4). At such time Seller and PacifiCorp agree to execute a written document ratifying the terms of this Agreement.
- 11.3.3 Damages. If this Agreement is terminated as a result of Seller's default, Seller shall pay PacifiCorp the positive difference, if any, obtained by subtracting the Contract Price from the Replacement Price for the Average Annual Generation that Seller was otherwise obligated to provide at the Guaranteed Availability for a period of twenty-four (24) months from the date of termination, plus any cost incurred for transmission purchased to deliver the replacement power to the Point of Delivery, plus the estimated administrative cost to the utility to acquire replacement power. Amounts owed by Seller pursuant to this paragraph shall be due within five (5) business days after any invoice from PacifiCorp for the same.
- 11.3.4 If this Agreement is terminated because of Seller's default, PacifiCorp may foreclose upon any security provided pursuant to Section 10 to satisfy any amounts that Seller owes PacifiCorp arising from such default.

11.4 Damages.

11.4.1 Failure to Deliver Net Output. In the event of Seller default under Subsection 11.1.5 or Subsection 11.1.6, then Seller shall pay PacifiCorp the positive difference, if any, obtained by subtracting the Contract Price from the Replacement Price for any Output Shortfall (under Section 4.3) during the period of default ("**Net Replacement Power Costs**"); *provided, however,* that the positive difference obtained by subtracting the Contract Price from the Replacement Price shall not exceed the Contract Price, and the period of default under this Section 11.4.1 shall not exceed one Contract Year.

11.4.2 Recoupment of Damages.

- (a) Default Security Available. If Seller has posted Default Security, PacifiCorp may draw upon that security to satisfy any damages, above.
  
- (b) Default Security Unavailable. If Seller has not posted Default Security, or if PacifiCorp has exhausted the Default Security, PacifiCorp may collect any remaining amount owing by partially withholding future payments to Seller over a reasonable period of time, which period shall not be less than the period over which the default occurred. PacifiCorp and Seller shall work together in good faith to establish the period, and monthly amounts, of such withholding so as to avoid Seller's default on its commercial or financing agreements necessary for its continued operation of the Facility.

## SECTION 12: INDEMNIFICATION AND LIABILITY

### 12.1 Indemnities.

12.1.1 Indemnity by Seller. Seller shall release, indemnify and hold harmless PacifiCorp, its directors, officers, agents, and representatives against and from any and all loss, fines, penalties, claims, actions or suits, including costs and attorney's fees, both at trial and on appeal, resulting from, or arising out of or in any way connected with (a) the energy delivered by Seller under this Agreement to and at the Point of Delivery, (b) any facilities on Seller's side of the Point of Delivery, (c) Seller's operation and/or maintenance of the Facility, or (d) arising from this Agreement, including without limitation any loss, claim, action or suit, for or on account of injury, bodily or otherwise, to, or death of, persons, or for damage to, or destruction or economic loss of property belonging to PacifiCorp, Seller or others, excepting only such loss, claim, action or suit as may be caused solely by the fault or gross negligence of PacifiCorp, its directors, officers, employees, agents or representatives.

12.1.2 Indemnity by PacifiCorp. PacifiCorp shall release, indemnify and hold harmless Seller, its directors, officers, agents, Lenders and representatives against and from any and all loss, fines, penalties, claims, actions or suits, including costs and attorney's fees, both at trial and on appeal, resulting from, or arising out of or in any way connected with the energy delivered by Seller under this Agreement after the Point of Delivery, including without limitation any loss, claim, action or suit, for or on account of injury, bodily or otherwise, to, or death of, persons, or for damage to, or destruction or economic loss of property, excepting only such loss, claim, action or suit as may be caused solely by the fault or gross negligence of Seller, its directors, officers, employees, agents, Lenders or representatives.

12.2 No Dedication. Nothing in this Agreement shall be construed to create any duty to, any standard of care with reference to, or any liability to any person not a Party to this Agreement. No undertaking by one Party to the other under any provision of this Agreement shall constitute the dedication of that Party's system or any portion thereof to the other Party or to the public, nor affect the status of PacifiCorp as an independent public utility corporation or Seller as an independent individual or entity.

12.3 No Consequential Damages. EXCEPT TO THE EXTENT SUCH DAMAGES ARE INCLUDED IN THE LIQUIDATED DAMAGES, DELAY DAMAGES, COST TO COVER DAMAGES OR OTHER SPECIFIED MEASURE OF DAMAGES EXPRESSLY PROVIDED FOR IN THIS AGREEMENT, NEITHER PARTY SHALL BE LIABLE TO THE OTHER PARTY FOR SPECIAL, PUNITIVE, INDIRECT, EXEMPLARY OR CONSEQUENTIAL DAMAGES, WHETHER SUCH DAMAGES ARE ALLOWED OR PROVIDED BY CONTRACT, TORT (INCLUDING NEGLIGENCE), STRICT LIABILITY, STATUTE OR OTHERWISE.

**SECTION 13: INSURANCE (FACILITIES OVER 200KW ONLY)**

13.1 Certificates. Prior to connection of the Facility to PacifiCorp's electric system, or another utility's electric system if delivery to PacifiCorp is to be accomplished by wheeling, Seller shall secure and continuously carry insurance in compliance with the requirements of this Section. Seller shall provide PacifiCorp insurance certificate(s) (of "ACORD Form" or the equivalent) certifying Seller's compliance with the insurance requirements hereunder. Commercial General Liability coverage written on a "claims-made" basis, if any, shall be specifically identified on the certificate. If requested by PacifiCorp, a copy of each insurance policy, certified as a true copy by an authorized representative of the issuing insurance company, shall be furnished to PacifiCorp.

13.2 Required Policies and Coverages. Without limiting any liabilities or any other obligations of Seller under this Agreement, Seller shall secure and continuously carry with an insurance company or companies rated not lower than "B+" by the A.M. Best Company the insurance coverage specified below:

13.2.1 Commercial General Liability insurance, to include contractual liability, with a minimum single limit of \$1,000,000 to protect against and from all loss by reason of injury to persons or damage to property based upon and arising out of the activity under this Agreement.

13.2.2 All Risk Property insurance providing coverage in an amount at least equal to the full replacement value of the Facility against "all risks" of physical loss or damage, including coverage for earth movement, flood, and boiler and machinery. The Risk policy may contain separate sub-limits and deductibles subject to insurance company underwriting guidelines. The Risk Policy will be maintained in accordance with terms available in the insurance market for similar facilities.

13.3 The Commercial General Liability policy required herein shall include i) provisions or endorsements naming PacifiCorp, its Board of Directors, Officers and employees as additional insureds, and ii) cross liability coverage so that the insurance applies separately to each insured against whom claim is made or suit is brought, even in instances where one insured claims against or sues another insured.

13.4 All liability policies required by this Agreement shall include provisions that such insurance is primary insurance with respect to the interests of PacifiCorp and that any other insurance maintained by PacifiCorp is excess and not contributory insurance with the insurance required hereunder, and provisions that such policies shall not be canceled or their limits of liability reduced without 1) ten (10) days prior written notice to PacifiCorp if canceled for nonpayment of premium, or 2) thirty (30) days prior written notice to PacifiCorp if canceled for any other reason.

13.5 Insurance coverage provided on a "claims-made" basis shall be maintained by Seller for a minimum period of five (5) years after the completion of this Agreement and for such other length of time necessary to cover liabilities arising out of the activities under this Agreement.

#### **SECTION 14: FORCE MAJEURE**

14.1 As used in this Agreement, "**Force Majeure**" or "**an event of Force Majeure**" means any cause beyond the reasonable control of the Seller or of PacifiCorp which, despite the exercise of due diligence, such Party is unable to prevent or overcome. By way of example, Force Majeure may include but is not limited to acts of God, fire, flood, storms, wars, hostilities, civil strife, strikes, and other labor disturbances, earthquakes, fires, lightning, epidemics, sabotage, restraint by court order or other delay or failure in the performance as a result of any action or inaction on behalf of a public authority which by the exercise of reasonable foresight such Party could not reasonably have been expected to avoid and by the exercise of due diligence, it shall be unable to overcome, subject, in each case, to the requirements of the first sentence of this paragraph. Force Majeure, however, specifically excludes the cost or availability of fuel or motive force resources to operate the Facility or changes in market conditions that affect the price of energy or transmission. If either Party is rendered wholly or in part unable to perform its obligation under this Agreement because of an event of Force Majeure, that Party shall be excused from whatever performance is affected by the event of Force Majeure to the extent and for the duration of the event of Force Majeure, after which such Party shall recommence performance of such obligation, provided that:

- 14.1.1 the non-performing Party, shall, within two (2) weeks after the occurrence of the Force Majeure, give the other Party written notice describing the particulars of the occurrence; and

14.1.2 the suspension of performance shall be of no greater scope and of no longer duration than is required by the event of Force Majeure; and

14.1.3 the non-performing Party uses its best efforts to remedy its inability to perform.

14.2 No obligations of either Party which arose before the Force Majeure causing the suspension of performance shall be excused as a result of the event of Force Majeure.

14.3 Neither Party shall be required to settle any strike, walkout, lockout or other labor dispute on terms which, in the sole judgment of the Party involved in the dispute, are contrary to the Party's best interests.

14.4 PacifiCorp may terminate the Agreement if Seller fails to remedy Seller's inability to perform, due to an event of Force Majeure, within six months after the occurrence of the event.

#### **SECTION 15: SEVERAL OBLIGATIONS**

Nothing contained in this Agreement shall ever be construed to create an association, trust, partnership or joint venture or to impose a trust or partnership duty, obligation or liability between the Parties. If Seller includes two or more parties, each such party shall be jointly and severally liable for Seller's obligations under this Agreement.

#### **SECTION 16: CHOICE OF LAW**

This Agreement shall be interpreted and enforced in accordance with the laws of the State of Oregon, excluding any choice of law rules which may direct the application of the laws of another jurisdiction.

#### **SECTION 17: PARTIAL INVALIDITY**

It is not the intention of the Parties to violate any laws governing the subject matter of this Agreement. If any of the terms of the Agreement are finally held or determined to be invalid, illegal or void as being contrary to any applicable law or public policy, all other terms of the Agreement shall remain in effect. If any terms are finally held or determined to be invalid, illegal or void, the Parties shall enter into negotiations concerning the terms affected by such decision for the purpose of achieving conformity with requirements of any applicable law and the intent of the Parties to this Agreement.

#### **SECTION 18: WAIVER**

Any waiver at any time by either Party of its rights with respect to a default under this Agreement or with respect to any other matters arising in connection with this Agreement must be in writing, and such waiver shall not be deemed a waiver with respect to any subsequent default or other matter.

#### **SECTION 19: GOVERNMENTAL JURISDICTIONS AND AUTHORIZATIONS**

This Agreement is subject to the jurisdiction of those governmental agencies having control over either Party or this Agreement. Seller shall at all times maintain in effect all local, state and federal licenses, permits and other approvals as then may be required by law for the construction, operation and maintenance of the Facility, and shall provide upon request copies of the same to PacifiCorp.

#### **SECTION 20: REPEAL OF PURPA**

This Agreement shall not terminate upon the repeal of the PURPA, unless such termination is mandated by federal or state law.

#### **SECTION 21: SUCCESSORS AND ASSIGNS**

This Agreement and all of the terms hereof shall be binding upon and inure to the benefit of the respective successors and assigns of the Parties. No assignment hereof by either Party shall become effective without the written consent of the other Party being first obtained and such consent shall not be unreasonably withheld, conditioned or delayed. Notwithstanding the foregoing, either Party may assign this Agreement without the other Party's consent to a lender as part of a financing transaction or as part of (a) a sale of all or substantially all of the assigning Party's assets, or (b) a merger, consolidation or other reorganization of the assigning Party.

#### **SECTION 22: ENTIRE AGREEMENT**

22.1 This Agreement supersedes all prior agreements, proposals, representations, negotiations, discussions or letters, whether oral or in writing, regarding PacifiCorp's purchase of Net Output from the Facility. No modification of this Agreement shall be effective unless it is in writing and signed by both Parties.



22.2 By executing this Agreement, Seller releases PacifiCorp from any claims, known or unknown, that may have arisen prior to the Effective Date.

**SECTION 23: NOTICES**

23.1 All notices except as otherwise provided in this Agreement shall be in writing, shall be directed as follows and shall be considered delivered if delivered in person or when deposited in the U.S. Mail, postage prepaid by certified or registered mail and return receipt requested.

Notices	PacifiCorp	Seller
<b>All Notices:</b>	PacifiCorp 825 NE Multnomah Street Portland, OR 97232 Attn: Contract Administration, Suite 600 Phone: (503) 813 - 5952 Facsimile: (503) 813 - 6291 Duns: 00-790-9013 Federal Tax ID Number: 93-0246090	Echo Projects Shared Facility Manager John Deere Renewables, LLC 6400 NW 86th Street Johnston, IA 50131 Phone: 877-539-4631 Facsimile: 515-267-4235 Email: jdrops@johndeere.com
<b>All Invoices:</b>	(same as street address above)  Attn: Back Office, Suite 700 Phone: (503) 813 - 5578 Facsimile: (503) 813 - 5580	Echo Projects Shared Facility Manager John Deere Renewables, LLC 6400 NW 86th Street Johnston, IA 50131 Phone: 515-267-4653 Facsimile: 515-267-4235
<b>Scheduling:</b>	(same as street address above)  Attn: Resource Planning, Suite 600 Phone: (503) 813 - 6090 Facsimile: (503) 813 - 6265	Echo Projects Shared Facility Manager John Deere Renewables, LLC 6400 NW 86th Street Johnston, IA 50131 Phone: 877-539-4631 Facsimile: 515-267-4235
<b>Payments:</b>	(same as street address above)  Attn: Back Office, Suite 700 Phone: (503) 813 - 5578 Facsimile: (503) 813 - 5580	Echo Projects Shared Facility Manager John Deere Renewables, LLC 6400 NW 86th Street Johnston, IA 50131 Phone: 515-267-4653 Facsimile: 515-267-4235 Email: jdracctg@johndeere.com
<b>Wire Transfer:</b>	Bank One N.A. ABA: ACCT: NAME: PacifiCorp Wholesale	Information to be provided in separate letter and treated as confidential.

<b>Credit and Collections:</b>	(same as street address above)  Attn: Credit Manager, Suite 1900 Phone: (503) 813 - 5684 Facsimile: (503) 813 - 5609	Echo Projects Shared Facility Manager John Deere Renewables, LLC 6400 NW 86th Street Johnston, IA 50131 Phone: 877-539-4631 Facsimile: 515-267-4235 Email: jdrops@johndeere.com
<b>With Additional Notices of an Event of Default or Potential Event of Default to:</b>	(same as street address above)  Attn: PacifiCorp General Counsel Phone: (503) 813-5029 Facsimile: (503) 813-7252	Echo Projects Shared Facility Manager John Deere Renewables, LLC 6400 NW 86th Street Johnston, IA 50131 Phone: 515-267-3065 Facsimile: 515-267-4235 Email: jdrlegal@johndeere.com

23.2 The Parties may change the person to whom such notices are addressed, or their addresses, by providing written notices thereof in accordance with this Section 23.

IN WITNESS WHEREOF, the Parties hereto have caused this Agreement to be executed in their respective names as of the date first above written.

PacifiCorp

By: [Signature]

Name: Bruce Griswold

Title: Director Short-term Origination and QF Contracts

Seller

By: [Signature]

Name: Rick S. Free

Title: Manager, Utility Relations and Regulatory Compliance

RSF 6-16-09

## EXHIBIT A-1

### DESCRIPTION OF SELLER'S FACILITY [Seller to Complete]

Seller's Facility consists of 5 generator(s).

**Manufacturer's Guaranteed Cut-in Wind Speed [if applicable]:** 6.7 MPH

**Facility Capacity Rating:** 10,000 kW

Assumed ambient conditions at Facility Capacity Rating: Reaches rated capacity at wind speed of 11 MPS or 24.6 MPH

Identify the maximum output of the generator(s) and describe any differences between that output and the Nameplate Capacity Rating. Maximum: 10,000 kW Explanation: None

**Station service requirements, and other loads served by the Facility, if any, are described as follows:** 137,456 KWh per year

**Location of the Facility:** The Facility is to be constructed in the vicinity of Hermiston in Umatilla County, Oregon. The location is more particularly described as follows:

T3N, R27E  
NE Qtr S22  
SW Qtr S23  
NW Qtr S26

**Power factor requirements:**

Rated Power Factor (PF) or reactive load (kVAR): Maintain unity PF at WTG terminals

**Unit Specification Notes:**

## EXHIBIT A-2

### UNIT SPECIFICATIONS

Unit	Manufacturer & Model	Synchronous	Number of Phases	Rated Output (kVA)	Rated Output (kW)	Rated Voltage (line to line)	Rated Current (A)		Max kVA Output	Max kW Output	Min kW Output
		or Induction					Stator	Rotor			
1.	REpower MM92, 2MW	Induction	3	2000	2000	3 X 575	2008	2008	2000	2000	20
2.	REpower MM92, 2MW	Induction	3	2000	2000	3 X 575	2008	2008	2000	2000	20
3.	REpower MM92, 2MW	Induction	3	2000	2000	3 X 575	2008	2008	2000	2000	20
4.	REpower MM92, 2MW	Induction	3	2000	2000	3 X 575	2008	2008	2000	2000	20
5.	REpower MM92, 2MW	Induction	3	2000	2000	3 X 575	2008	2008	2000	2000	20

**EXHIBIT B**

**SELLER'S INTERCONNECTION FACILITIES**

[Seller to provide its own diagram and description]

**POINT OF DELIVERY / SELLER'S INTERCONNECTION FACILITIES**

Instructions to Seller:

1. Include description of point of metering, and Point of Delivery
2. Provide interconnection single line drawing of Facility including any transmission facilities on Seller's side of the Point of Delivery.



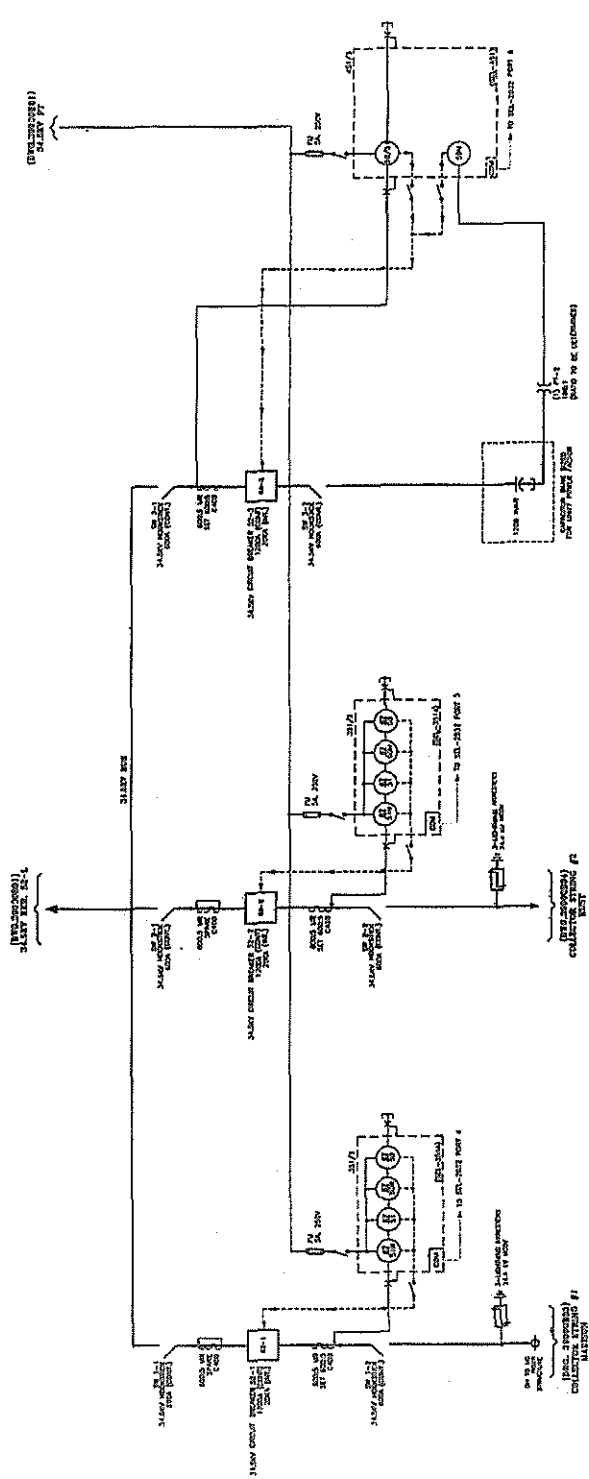

- LEGEND:**
- 1. 3450V CIRCUIT BREAKER
  - 2. 3450V/240V TRANSFORMER
  - 3. 240V CIRCUIT BREAKER
  - 4. 240V FUSE
  - 5. 240V SWITCH
  - 6. 240V FUSE
  - 7. 240V SWITCH
  - 8. 240V FUSE
  - 9. 240V SWITCH
  - 10. 240V FUSE
  - 11. 240V SWITCH
  - 12. 240V FUSE
  - 13. 240V SWITCH
  - 14. 240V FUSE
  - 15. 240V SWITCH
  - 16. 240V FUSE
  - 17. 240V SWITCH
  - 18. 240V FUSE
  - 19. 240V SWITCH
  - 20. 240V FUSE
  - 21. 240V SWITCH
  - 22. 240V FUSE
  - 23. 240V SWITCH
  - 24. 240V FUSE
  - 25. 240V SWITCH
  - 26. 240V FUSE
  - 27. 240V SWITCH
  - 28. 240V FUSE
  - 29. 240V SWITCH
  - 30. 240V FUSE
  - 31. 240V SWITCH
  - 32. 240V FUSE
  - 33. 240V SWITCH
  - 34. 240V FUSE
  - 35. 240V SWITCH
  - 36. 240V FUSE
  - 37. 240V SWITCH
  - 38. 240V FUSE
  - 39. 240V SWITCH
  - 40. 240V FUSE
  - 41. 240V SWITCH
  - 42. 240V FUSE
  - 43. 240V SWITCH
  - 44. 240V FUSE
  - 45. 240V SWITCH
  - 46. 240V FUSE
  - 47. 240V SWITCH
  - 48. 240V FUSE
  - 49. 240V SWITCH
  - 50. 240V FUSE
  - 51. 240V SWITCH
  - 52. 240V FUSE
  - 53. 240V SWITCH
  - 54. 240V FUSE
  - 55. 240V SWITCH
  - 56. 240V FUSE
  - 57. 240V SWITCH
  - 58. 240V FUSE
  - 59. 240V SWITCH
  - 60. 240V FUSE
  - 61. 240V SWITCH
  - 62. 240V FUSE
  - 63. 240V SWITCH
  - 64. 240V FUSE
  - 65. 240V SWITCH
  - 66. 240V FUSE
  - 67. 240V SWITCH
  - 68. 240V FUSE
  - 69. 240V SWITCH
  - 70. 240V FUSE
  - 71. 240V SWITCH
  - 72. 240V FUSE
  - 73. 240V SWITCH
  - 74. 240V FUSE
  - 75. 240V SWITCH
  - 76. 240V FUSE
  - 77. 240V SWITCH
  - 78. 240V FUSE
  - 79. 240V SWITCH
  - 80. 240V FUSE
  - 81. 240V SWITCH
  - 82. 240V FUSE
  - 83. 240V SWITCH
  - 84. 240V FUSE
  - 85. 240V SWITCH
  - 86. 240V FUSE
  - 87. 240V SWITCH
  - 88. 240V FUSE
  - 89. 240V SWITCH
  - 90. 240V FUSE
  - 91. 240V SWITCH
  - 92. 240V FUSE
  - 93. 240V SWITCH
  - 94. 240V FUSE
  - 95. 240V SWITCH
  - 96. 240V FUSE
  - 97. 240V SWITCH
  - 98. 240V FUSE
  - 99. 240V SWITCH
  - 100. 240V FUSE

**JOHN DEERE RENEWABLES, LLC**  
 SUBSTATION SINGLE LINE DIAGRAM (SL 2 OF 2)  
 ECHO WIND FARMS  
 RNDJMA MDJ 99000802 D

**MATERIAL RECEIPT VERIFICATION**  
 BEFORE AS WORKS OF RECORD, CONTRACTOR SHALL VERIFY ALL MATERIALS AND EQUIPMENT LISTED ON THIS ASSOCIATED SUBSTATION EXHAUSTIVE LISTING. MATERIALS LISTED SHALL BE SHOWN IN THE MATERIAL RECEIPT AND TRACKING EXPENSE 774-537-8011.

FOR APPROVAL BY THE ASSOCIATED SUBSTATION ENGINEER:  
 SUBSTATION ENGINEER, INC.

FOR APPROVAL BY THE ASSOCIATED CONTRACTOR:  
 CONTRACTOR

FOR APPROVAL BY THE ASSOCIATED OWNER:  
 OWNER

FOR APPROVAL BY THE ASSOCIATED DESIGNER:  
 DESIGNER

FOR APPROVAL BY THE ASSOCIATED INSPECTOR:  
 INSPECTOR

FOR APPROVAL BY THE ASSOCIATED SURVEYOR:  
 SURVEYOR

FOR APPROVAL BY THE ASSOCIATED TESTER:  
 TESTER

FOR APPROVAL BY THE ASSOCIATED WELDER:  
 WELDER

FOR APPROVAL BY THE ASSOCIATED MILLER OPERATOR:  
 MILLER OPERATOR

FOR APPROVAL BY THE ASSOCIATED RIG OPERATOR:  
 RIG OPERATOR

FOR APPROVAL BY THE ASSOCIATED CRANE OPERATOR:  
 CRANE OPERATOR

FOR APPROVAL BY THE ASSOCIATED HOIST OPERATOR:  
 HOIST OPERATOR

FOR APPROVAL BY THE ASSOCIATED SCAFFOLD OPERATOR:  
 SCAFFOLD OPERATOR

FOR APPROVAL BY THE ASSOCIATED LIFTING OPERATOR:  
 LIFTING OPERATOR

FOR APPROVAL BY THE ASSOCIATED TOWER OPERATOR:  
 TOWER OPERATOR

FOR APPROVAL BY THE ASSOCIATED WIND OPERATOR:  
 WIND OPERATOR

FOR APPROVAL BY THE ASSOCIATED GENERATOR OPERATOR:  
 GENERATOR OPERATOR

FOR APPROVAL BY THE ASSOCIATED TRANSFORMER OPERATOR:  
 TRANSFORMER OPERATOR

FOR APPROVAL BY THE ASSOCIATED SWITCH OPERATOR:  
 SWITCH OPERATOR

FOR APPROVAL BY THE ASSOCIATED FUSE OPERATOR:  
 FUSE OPERATOR

FOR APPROVAL BY THE ASSOCIATED CIRCUIT BREAKER OPERATOR:  
 CIRCUIT BREAKER OPERATOR

FOR APPROVAL BY THE ASSOCIATED BUS OPERATOR:  
 BUS OPERATOR

FOR APPROVAL BY THE ASSOCIATED GROUNDING OPERATOR:  
 GROUNDING OPERATOR

FOR APPROVAL BY THE ASSOCIATED PROTECTIVE OPERATOR:  
 PROTECTIVE OPERATOR

FOR APPROVAL BY THE ASSOCIATED CONTROL OPERATOR:  
 CONTROL OPERATOR

FOR APPROVAL BY THE ASSOCIATED MONITORING OPERATOR:  
 MONITORING OPERATOR

FOR APPROVAL BY THE ASSOCIATED RECORDING OPERATOR:  
 RECORDING OPERATOR

FOR APPROVAL BY THE ASSOCIATED DATA OPERATOR:  
 DATA OPERATOR

FOR APPROVAL BY THE ASSOCIATED ANALYSIS OPERATOR:  
 ANALYSIS OPERATOR

FOR APPROVAL BY THE ASSOCIATED REPORTING OPERATOR:  
 REPORTING OPERATOR

FOR APPROVAL BY THE ASSOCIATED ARCHIVING OPERATOR:  
 ARCHIVING OPERATOR

FOR APPROVAL BY THE ASSOCIATED RETRIEVAL OPERATOR:  
 RETRIEVAL OPERATOR

FOR APPROVAL BY THE ASSOCIATED DISTRIBUTION OPERATOR:  
 DISTRIBUTION OPERATOR

FOR APPROVAL BY THE ASSOCIATED ACCESS OPERATOR:  
 ACCESS OPERATOR

FOR APPROVAL BY THE ASSOCIATED SECURITY OPERATOR:  
 SECURITY OPERATOR

FOR APPROVAL BY THE ASSOCIATED COMPLIANCE OPERATOR:  
 COMPLIANCE OPERATOR

FOR APPROVAL BY THE ASSOCIATED QUALITY OPERATOR:  
 QUALITY OPERATOR

FOR APPROVAL BY THE ASSOCIATED ENVIRONMENTAL OPERATOR:  
 ENVIRONMENTAL OPERATOR

FOR APPROVAL BY THE ASSOCIATED SOCIAL OPERATOR:  
 SOCIAL OPERATOR

FOR APPROVAL BY THE ASSOCIATED GOVERNANCE OPERATOR:  
 GOVERNANCE OPERATOR

FOR APPROVAL BY THE ASSOCIATED ETHICS OPERATOR:  
 ETHICS OPERATOR

FOR APPROVAL BY THE ASSOCIATED INTEGRITY OPERATOR:  
 INTEGRITY OPERATOR

FOR APPROVAL BY THE ASSOCIATED HONESTY OPERATOR:  
 HONESTY OPERATOR

FOR APPROVAL BY THE ASSOCIATED FAITHFULNESS OPERATOR:  
 FAITHFULNESS OPERATOR

FOR APPROVAL BY THE ASSOCIATED COURAGE OPERATOR:  
 COURAGE OPERATOR

FOR APPROVAL BY THE ASSOCIATED RESPECT OPERATOR:  
 RESPECT OPERATOR

FOR APPROVAL BY THE ASSOCIATED KINDNESS OPERATOR:  
 KINDNESS OPERATOR

FOR APPROVAL BY THE ASSOCIATED PATIENCE OPERATOR:  
 PATIENCE OPERATOR

FOR APPROVAL BY THE ASSOCIATED HUMILITY OPERATOR:  
 HUMILITY OPERATOR

FOR APPROVAL BY THE ASSOCIATED GRACE OPERATOR:  
 GRACE OPERATOR

FOR APPROVAL BY THE ASSOCIATED MERCY OPERATOR:  
 MERCY OPERATOR

FOR APPROVAL BY THE ASSOCIATED COMPASSION OPERATOR:  
 COMPASSION OPERATOR

FOR APPROVAL BY THE ASSOCIATED GENTLENESS OPERATOR:  
 GENTLENESS OPERATOR

FOR APPROVAL BY THE ASSOCIATED MILDNESS OPERATOR:  
 MILDNESS OPERATOR

FOR APPROVAL BY THE ASSOCIATED MEANNESS OPERATOR:  
 MEANNESS OPERATOR

FOR APPROVAL BY THE ASSOCIATED RIGHTEOUSNESS OPERATOR:  
 RIGHTEOUSNESS OPERATOR

FOR APPROVAL BY THE ASSOCIATED PEACE OPERATOR:  
 PEACE OPERATOR

FOR APPROVAL BY THE ASSOCIATED LOVE OPERATOR:  
 LOVE OPERATOR







## EXHIBIT C

### REQUIRED FACILITY DOCUMENTS

#### REQUIRED OF ALL FACILITIES

- QF Certification
- Interconnection Agreement
- Fuel Supply Agreement, if applicable

#### REQUIRED IF SELLER ELECTS TO GRANT SENIOR LIEN OR STEP-IN RIGHTS:

- Deed or Lease to Facility Premises
- Preliminary Title Report of Premises
- Proof of ownership of Facility
- Off-take sale agreements, e.g. surplus heat sale contract, if applicable

Depending upon the type of Facility and its specific characteristics, additional Required Facility Documents may be requested.

#### OTHER (if any)

- QF Number: QF08-372-000
- Addendum A - Security and Curtailment
- Addendum L - Line Losses and Station Service
- Parental Guaranty Documentation
- Addendum R - Clarification of Contract Price
- Generation Interconnection Agreement - Provided May 29, 2009

**ADDENDUM A**  
**Clarification of Certain Terms in the Power Purchase Agreement**

*Whereas*, during the course of negotiating this Power Purchase Agreement ("PPA"), the Parties discussed (1) Seller's obligations under the PPA to enter into and operate subject to a Generation Interconnection Agreement with PacifiCorp Transmission, the interconnection provider ("PacTrans"), (2) the need to procure and pay for firm transmission service(s), under arrangements separate and distinct from this PPA, from the required transmission service provider(s), including but not limited to PacTrans ("Transmission Service Provider"), to transmit the Net Output from the Point of Delivery to PacifiCorp's Network Load ("Transmission Service(s)"), and (3) the potential for abnormal events during the term of this PPA which could affect the transmission of the Net Output of the Facility from the Point of Delivery to PacifiCorp's Network Load; and

*Whereas*, the Parties understand and agree that as part of Buyer's obligation to purchase all Net Output of the Facility set forth in Section 4.1 of the PPA, prior to executing this PPA, Buyer has received confirmation that designation of the Facility as Buyer's Network Resource has been approved and that the associated firm Transmission Service(s) are in place at Buyer's sole cost, as required to transmit the Net Output of the Facility from the Point of Delivery to PacifiCorp's Network Load.

*Whereas*, neither PacifiCorp's Oregon Schedule 37 nor the PPA set forth explicitly and without ambiguity what the Credit Requirements in the PPA would be in the event Deere & Company no longer provides a guaranty as a result of its interest in the Seller being sold or for any other reason; and

*Whereas*, in order to minimize the likelihood of future dispute, the Parties wish to memorialize their intent and agreement with regard to the above issues;

NOW, THEREFORE, the Parties do hereby declare and agree as follows:

**1. Capitalized Terms.** Except as otherwise defined herein, all capitalized terms in this Addendum A shall have the meaning set forth in this Agreement.

**2. Firm Transmission Service Curtailment.** In accordance with Section 6.3 of the PPA, PacifiCorp shall not be obligated to purchase, receive or pay for Net Output (nor shall it be liable for corresponding unrealized Production Tax Credits or Environmental Attributes) to the extent that such Net Output can not be accepted at the Point of Delivery because (a) the interconnection between the Facility and the System is disconnected, suspended or interrupted, in whole or in part, pursuant to the terms of the Generation Interconnection Agreement, (b) Firm Transmission Service(s) (as defined in an Open Access Transmission Tariff ("OATT") or state regulation), including those for this PPA, are curtailed at the direction of the System Operator in accordance with the OATT, or (c) an event of Force Majeure prevents Seller from delivering or PacifiCorp from accepting Net Output. PacifiCorp shall procure and maintain Firm Transmission Services for Seller's Net Output (unless doing so would violate state or federal statute, regulation, or binding order).

**3. Limitation of Impact on Facility Availability.** Except for curtailments resulting from Seller's non-compliance with its Generation Interconnection Agreement

## ADDENDUM A--Ctd

(which shall be included in Downtime Hours), hours during which Seller's Net Output is curtailed for reasons (a), (b), or (c), in paragraph 2 above, shall not be included in Downtime Hours and shall not otherwise change the Availability determined for the Facility. Within five (5) business days of the resumption of full transmission service, Seller shall transmit to PacifiCorp's Back Office (or cause the Transmission Service Provider to transmit to PacifiCorp's Back Office) a written statement documenting the time curtailment commenced, the amount of curtailment during each hour of the curtailment period, and the time curtailment ended. Seller shall promptly provide Buyer such information and data as Buyer may reasonably require to confirm the duration and magnitude of curtailment of Seller's Net Output for reasons (a), (b), or (c), in paragraph 2, above.

4. **Changes in Security.** Seller may, during the term of this Agreement, substitute one form of credit security for another form of credit security allowed in Section 10, subject to PacifiCorp's consent, which shall not be unreasonably conditioned, delayed or withheld; *provided, that* PacifiCorp may review and approve (or disapprove) Seller's proposed substitution based on criteria no more restrictive than PacifiCorp would have applied at the time of execution of this Agreement.

5. **Intent.** Upon execution by the Parties, the terms of this Addendum A shall be incorporated into the PPA.

IN WITNESS WHEREOF, the Parties hereto acknowledge this Addendum A to be part of the Power Purchase Agreement between PacifiCorp and Seller.

PacifiCorp

By: \_\_\_\_\_

Name: Bruce Griswold

Title: Director, Short-Term Origination  
and QF Contracts

Four Corners Windfarm, LLC

By: \_\_\_\_\_

Name: Terry Kramer

Title: Manager

*RF  
RST  
6-16-09*

# ADDENDUM L

## STATION LOAD, LOSSES, and NET OUTPUT ALLOCATION ALGORITHM for the Echo Projects

This Addendum L is hereby made a part of, and clarifies certain terms in, the Oregon Standard Firm Qualifying Facility Power Purchase Agreement for Intermittent Resources 10 MW or Less (the "Agreement") entered into the 19 day of December, 2008 by and between Four Corners Windfarm, LLC, a Oregon limited liability corporation (the "Seller") and PacifiCorp (d/b/a Pacific Power & Light Company), an Oregon corporation, acting in its regulated utility capacity ("PacifiCorp"). Seller and PacifiCorp are at times referred to herein individually as a "Party" or collectively as the "Parties".

Four Corners Windfarm, LLC, Four Mile Canyon Windfarm LLC, Oregon Trail Windfarm, LLC, Sand Ranch Windfarm, LLC, Butter Creek Power, LLC, Big Top, LLC, Wagon Trail, LLC, Ward Butte Windfarm, LLC, and Pacific Canyon Windfarm, LLC, together comprise the "Echo Projects", a complex of separate, Oregon standard wind Qualifying Facilities, that share collector wires, a 34.5/69 kV substation, a 69 kV line, and related equipment, which connect the Qualifying Facilities to the Point of Delivery ("Shared Interconnection Facilities").

PacifiCorp has agreed to buy (and Seller has agreed to sell), at the Point of Delivery, Seller's total energy output net of: (1) Seller's station service; (2) energy provided by Seller to another Echo Project(s) for station service; (3) Seller's share of the transformation losses; and (4) Seller's share of the line losses between Seller's Facility and the Point of Delivery (together Seller's "Station Auxiliary Load and Losses"). However, Seller and PacifiCorp agree that it is impossible to measure Seller's Station Auxiliary Load and Losses separate and apart from the Station Auxiliary Load and Losses of the other Echo Projects. Therefore, in order to implement an objective, practicable, and equitable process by which PacifiCorp may quantify energy delivered by Seller to the Point of Delivery (net of its Station Auxiliary Load and Losses), the Parties do agree as follows:

**A. Billing Formulae.** PacifiCorp shall determine Seller's Net Output in kWh for purposes of the Agreement using the method specified below.

### 1. Definitions

$NR_i$  = the nameplate rating of Echo Project  $i$ .

$NR_T$  = the sum of all the nameplate ratings of Echo Projects ( $i = 1$  to  $9$ ).

- $PALL_T$  = the accumulated purchased energy from Utility Supplier(s), as determined at the Point of Delivery, to supply the net total station auxiliary load and losses for the Shared Interconnection Facilities for Echo Projects  $i = 1$  to 9 whenever such total load and losses exceeds total generation output.
- $PALL_i$  = the allocated share of  $PALL_T$  for Project  $i$  as determined by multiplying  $PALL_T$  by  $NR_i$  and dividing by  $NR_T$ .
- $OP_i$  = for a given integration interval, the metered output energy of Echo Project  $i$ , as determined by PacifiCorp's meter at the point where Echo Project  $i$  connects to the Shared Interconnection Facilities. For any integration interval during which any energy is delivered to a Project from the Shared Interconnection Facilities, such delivered energy is accumulated in a separate meter register and does not decrement the register used to measure accumulated  $OP_i$ . Therefore  $OP_i$  is by definition always greater than or equal to zero, and in the event the meter records  $OP_i$  less than zero,  $OP_i$  shall be deemed to equal zero.
- $OP_T$  = the sum of all  $OP_i$  ( $i = 1$  to 9).
- $NO_T$  = for a given integration interval, the total energy delivered to the Point of Delivery (69 KV Busbar of PacifiCorp's Hinkle Substation).  $NO_T$  shall be as measured at PacifiCorp's meter near the Point of Delivery (kWh, in 10-minute intervals), adjusted for any transformation losses between the meter and the Point of Delivery. For any integration interval during which any energy is delivered to the Point of Delivery from PacifiCorp's system, such delivered energy is accumulated in a separate meter register of the PacifiCorp meter and does not decrement the register used to measure accumulated Net Output energy. Therefore  $NO_T$  is by definition always greater than or equal to zero and in the event the meter records  $NO_T$  less than zero,  $NO_T$  shall be deemed to equal zero.
- $NO_i$  = the net energy sold to PacifiCorp by Echo Project  $i$  during the integration interval.
- $SALL_T$  = the total of all station auxiliary load and losses for the Shared Interconnection Facilities for Echo Projects ( $i = 1$  to 9) when  $NO_T$  is positive.
- $SALL_i$  = the allocated share for Echo Project  $i$  of  $SALL_T$ .

Capitalized terms not defined in this Addendum shall have the meaning set forth in the Agreement.

## 2. Calculations

Calculations shall be reconciled and settled monthly. Calculations shall be based upon raw data gathered from specified meters using a metering integration interval of 5, 10, or 15 minutes at PacifiCorp's election to match the metering installation PacifiCorp specified ("**integration interval**"). Calculations shall be rounded to the nearest kilowatt-hour in the final step.

### (a). When Total Generation Output $\leq$ Station Auxiliary Load and Losses

When, for any integration interval, the total of all  $OP_i$  Project output amounts of energy among all Echo Projects ( $OP_T$ ) is less than or equal to the total station auxiliary load and losses for the Shared Interconnection Facilities, the meters at the Point of Delivery will accumulate the Utility Supplier's delivery of purchased energy,  $PALL_T$ , to supply such net total load and losses in a meter register that is separate from that which accumulates  $NO_T$  and  $NO_T$  shall equal zero or if negative, be deemed to equal zero. The "**Utility Supplier**" shall be the utility with the right (franchise) to provide retail electric service at the Facility (Umatilla Electric Co-op and or Columbia Basin Electric Co-op). PacifiCorp shall have no obligation to serve any of the Echo Projects' retail electric needs absent a separate written agreement with PacifiCorp and then only with the permission of Seller's Utility Supplier. None of the costs associated with provision of retail electric service to Seller shall be borne by PacifiCorp.

### (b). When Total Generation Output $>$ Station Auxiliary Load and Losses

When, for any integration interval, the total generation of energy among all Echo Projects is greater than the total station auxiliary load and losses for the Shared Interconnection Facilities, the meters at the Point of Delivery will accumulate in a separate register PacifiCorp's receipt of the total combined energy from all the Projects ( $NO_T$ ). The difference between  $OP_T$  and  $NO_T$  for that interval ( $SALL_T$ ) is allocated to each Echo Project in proportion to its generation output ( $OP_i$ ) in the same integration interval to determine  $NO_i$  by the formulae:

Let  $SALL_T = [OP_T - NO_T]$  and

$$SALL_i = [SALL_T] * [OP_i / OP_T]$$

The Net Output energy sold by each Project  $i$  is then determined as:

$$NO_i = [OP_i - SALL_i] \text{ and substituting for } SALL_i ;$$

$$NO_i = NO_T * [OP_i / OP_T]$$

**B. Limitation of PacifiCorp Purchase Liability.** PacifiCorp's total purchase obligation to the Echo Projects shall at no time exceed total energy delivered by the Echo Projects to the Point of Delivery. Therefore, in the event the sum of the Net Output

energy (calculated according to the preceding formulae) for all the Echo Projects is greater than  $NO_T$ , then PacifiCorp shall reduce calculated Net Output energy from each Echo Project, pro rata each Echo Project's share of the  $OP_T$ , such that the total energy purchased from all the Echo Projects at the Point of Delivery by PacifiCorp equals  $NO_T$ .

**C. PacifiCorp Right to Offset.** In the event PacifiCorp determines it has underpaid one or more Echo Projects (due to metering error or otherwise) and, as a result of underpaying one or more Echo Projects, has overpaid Seller, PacifiCorp may adjust Seller's future payment(s) accordingly in order to recapture any overpayment received by Seller in a reasonable time.

**D. Condition Subsequent.** This Addendum L was negotiated jointly among the Echo Projects and PacifiCorp and is intended by all of the Echo Projects and PacifiCorp to be one of nine identical bilateral agreements, each between PacifiCorp and an Echo Project, but each related to the other. Therefore, in the event one or more Echo Projects does not agree to be bound by the terms and conditions set forth in this Addendum L, PacifiCorp may, upon thirty days written notice, cancel all Addendum L agreements. In the event PacifiCorp cancels this Addendum L in accordance with this Section 4, PacifiCorp may satisfy its obligation to pay Seller by depositing when due, with an escrow agent chosen by the Echo Projects, the total payment due to all Echo Projects under their respective Power Purchase Agreements, less offsets (if any) calculated based upon  $NO_T$  and the Contract Price.

**E. Recital E to the Power Purchase Agreement.** The Parties' intentionally left blank the elective options in Recital E to their Agreement because neither option describes the Parties' intent. The Parties intend that, when  $NO_T$  is greater than zero, Seller's full electric requirements will be served by its gross output or by the Net Output of other Echo Projects. When  $NO_T$  is less than or equal to zero, Seller's full electric requirements at the Point of Delivery will be served by Seller's Utility Supplier.

**AGREED TO BY:**

PacifiCorp

By: \_\_\_\_\_

Name: Bruce Griswold

Title: Director, Short-Term Origination  
and QF Contracts

Four Corners Windfarm LLC

By: \_\_\_\_\_

Name: Terry Kramer

Title: Manager



**ADDENDUM R**  
(Clarification of Contract Price)

This Addendum R is hereby made a part of, and clarifies certain terms in, the Oregon Standard Firm Qualifying Facility Power Purchase Agreement for Intermittent Resources 10 MW or Less (the "**Agreement**") entered into the 15<sup>th</sup> day of June, 2009, by and between **Four Corners Windfarm, LLC**, a Oregon limited liability company ("**Seller**") and PacifiCorp (d/b/a Pacific Power & Light Company), an Oregon corporation, acting in its regulated utility capacity ("**PacifiCorp**"). Seller and PacifiCorp are at times referred to herein individually as a "Party" or collectively as the "Parties".

*Whereas*, the Agreement provides that PacifiCorp shall pay Seller the Fixed Avoided Cost Price from PacifiCorp's Oregon Schedule 37 Tariff ("**Schedule 37**", attached to the Agreement as Exhibit G) for fifteen years commencing on the Scheduled Initial Delivery Date, and thereafter PacifiCorp shall pay Seller the Firm Market Index Avoided Cost Price; and

*Whereas*, the Fixed Avoided Cost Prices set forth in Schedule 37 (in "Pricing Option 1", page 5) inadvertently omitted pricing for calendar years after year 2023; and

*Whereas*, Seller is entitled under the Agreement to be paid the Fixed Avoided Cost Price until June 30, 2024 (such day being exactly fifteen years after the 2009 Scheduled Initial Delivery Date) ("**Changeover Date**"); and

*Whereas*, the filed and approved Fixed Avoided Cost Prices for years 2012 through 2028 are set forth in columns "f" and "g" of Pricing Option 2, on page 6 of Schedule 37; and

*Whereas*, the Parties wish to memorialize and document their agreement on the Contract Prices throughout the term of the Agreement.

NOW, THEREFORE, the Parties do hereby declare and agree as follows:

1. **Capitalized Terms.** Except as otherwise specified herein, all capitalized terms in this Addendum R shall have the meaning set forth in the Agreement.

2. **Contract Price during period omitted from Pricing Option 1 in Schedule 37.** Commencing at 12:01 a.m. on January 1, 2024, until the Changeover Date, the Contract Price shall be as follows:



On-Peak Contract Price:	9.04 cents/kwh
Off-Peak Contract Price:	6.76 cents/kwh

From the Changeover Date until the Termination Date, the Contract Price shall be the price specified by Section 5.2 of the Agreement.

3. **Contract Price.** The Parties hereby agree that the Contract Price during term of the Agreement shall be the corresponding Contract Price, below.

Year	On-Peak ¢/kWh	Off- Peak ¢/kWh
2009	7.11	5.62
2010	7.21	5.59
2011	7.16	5.42
2012	7.68	5.86
2013	7.72	5.86
2014	7.95	6.06
2015	8.25	6.32
2016	8.40	6.44
2017	8.55	6.55
2018	8.69	6.66
2019	8.86	6.78
2020	9.03	6.91
2021	9.01	6.86
2022	9.03	6.83
2023	9.06	6.82
2024, until Changeover Date:	9.04	6.76
2024, from Changeover Date until Termination Date:	Price specified by Section 5.2 of the Agreement	

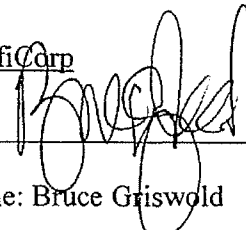
**AGREED TO BY:**

PacificCorp  
 By:    
 Name: Bruce Griswold  
 Title: Director, Short-Term Origination  
 and QF Contracts

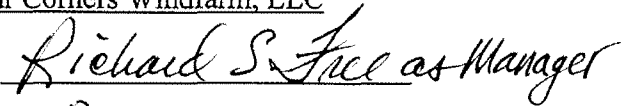
Four Corners Windfarm, LLC  
 By:   
 Name: RICHARD S. FREE  
 Title: MANAGER

## EXHIBIT D-1

### SELLER'S MOTIVE FORCE PLAN

#### A. MONTHLY DELIVERY SCHEDULES AND SCHEDULED MAINTENANCE

Seller provide an estimate of the average monthly Net Output of the Facility, and explain the basis for the estimate.

Month	Average Energy (kWh)
January	1,931,000 kWh
February	1,660,000 kWh
March	2,316,000 kWh
April	2,427,000 kWh
May	2,660,000 kWh
June	2,709,000 kWh
July	2,739,000 kWh
August	2,611,000 kWh
September	2,273,000 kWh
October	2,349,000 kWh
November	2,190,000 kWh
December	1,842,000 kWh

Explanation: The area where the wind turbines are located has been monitored for over a year with a 50 m meteorological tower measuring wind speeds at four levels and wind direction at 2 levels. The instruments collect data at 10 minute intervals. These readings have been correlated with an anemometer located at the Hermiston Airport, which has a long term record. This analysis is performed by wind direction sector and results in an estimated long term wind speed at 50 m. The onsite data is again analyzed by sector to determine the acceleration of wind speeds as a function of height above ground level (wind shear). These sector shears are used to predict the long term wind speeds at the level of the wind turbine hub (80 m). The calculated 80 m long term wind speeds were converted to hourly energy production estimates by using the power curve of a Vestas V82. These estimates were aggregated by month to determine the percent of annual energy generated in each month. This estimate is applicable to a wind turbine at the location of the meteorological tower. An experienced meteorologist estimated the effect terrain differences between each wind turbine site and the meteorological tower location would have on expected wind speeds. He also estimated the energy losses which would be caused by interaction between wind turbines, known as array losses. The speed adjustment and array losses are used to calculate the projected annual average energy production of each wind turbine. Finally, the wind turbine's annual production is allocated to months using the percentages described above.

**EXHIBIT D-2**

**ENGINEER'S CERTIFICATION  
OF  
MOTIVE FORCE PLAN**

*Seller provide a written declaration from a Licensed Professional Engineer to PacifiCorp that the Facility is likely capable under average conditions foreseeable during the term of this Agreement of meeting Seller's estimated average, maximum, and minimum Net Output.*



## Certification of Four Corners Windfarm, LLC

By  
Jack Kline, CCM  
RAM Associates  
Brentwood, CA

March 20, 2009

### Project Description

The Four Corners Windfarm is comprised of five REpower model MM92 wind turbines, each having a rated power of 2.0 MW and a hub height of 80 m AGL. The sites are designated as I1 through I5 and are located in Sections 22, 23 and 26 of Twp 3N, Rng 27E in Umatilla County, Oregon. Other similar wind farms are proposed to be developed on neighboring parcels of land in the same area.

### Wind Resource

Wind resource data has been collected at a number of anemometer towers across the project site. The data have been correlated to a long term reference site at Hermiston, OR, located approximately 11 miles north-northeast of the project site, and long-term mean wind speeds have been estimated at the anemometer tower sites. Terrain modeling of the wind resource has been performed to determine the long-term mean wind speeds at the hub height level of each turbine site.

### Turbine Energy Estimates

The on-site wind data and individual turbine wind speed estimates have been used in conjunction with the power curve for the Repower MM92 (appropriate for the air density at the site) to calculate long-term mean gross energy for each turbine site in the project. Loss factors have been applied to produce net energy for each turbine. Losses for high-speed hysteresis stop/restart and array losses (considering all turbines that will be erected at the site) were calculated and all other losses were assumed, based on typical values currently used in the wind industry. After applying these loss factors the combined long-term average net energy for the six turbines has been calculated. The uncertainty in project output has been evaluated and the output is certified to be 27,707,000 kWh/year at the P90 level.

Four Corners Windfarm, LLC  
 Echo 2 - Forecast to PacifiCorp  
 Model MM92 - 2 MW

		Losses	Availability	P90 Gross Capacity Factor	Days/mo.	Hrs/mo	Nameplate Capacity	Forecast	
<u>Test</u>	Jul-09	5.7%	20.0%	42.8%	31	744	10	601	
<u>Energy</u>	Aug-09	5.7%	30.0%	40.8%	31	744	10	859	
								1459	Total

		Losses	Availability	P90 Gross Capacity Factor	Days/mo.	Hrs/mo	Nameplate Capacity	Forecast	
	September-09	5.7%	80.0%	36.7%	30	720	10	1994	
	October-09	5.7%	85.0%	36.7%	31	744	10	2190	
<u>First</u>	November-09	8.2%	90.0%	36.3%	30	720	10	2161	
<u>Contract</u>	December-09	9.4%	91.2%	30.0%	31	744	10	1842	
<u>Year</u>								8187	Total

		Losses	Availability	P90 Gross Capacity Factor	Days/mo.	Hrs/mo	Nameplate Capacity	Forecast	
	January-10	9.6%	91.2%	31.5%	31	744	10	1931	
	February-10	9.6%	91.2%	30.0%	28	672	10	1660	
	March-10	9.4%	91.2%	37.7%	31	744	10	2316	
	April-10	5.7%	91.2%	39.2%	30	720	10	2427	
	May-10	5.7%	91.2%	41.6%	31	744	10	2660	
	June-10	5.7%	91.2%	43.8%	30	720	10	2709	
	July-10	5.7%	91.2%	42.8%	31	744	10	2739	
<u>Second</u>	August-10	5.7%	91.2%	40.8%	31	744	10	2611	
<u>Contract</u>	September-10	5.7%	91.2%	36.7%	30	720	10	2273	
<u>Year</u>	October-10	5.7%	91.2%	36.7%	31	744	10	2349	
	November-10	8.2%	91.2%	36.3%	30	720	10	2190	
	December-10	9.4%	91.2%	30.0%	31	744	10	1842	
								27707	Total

Average Annual Generation

Test Energy	1459
First Contract Year	8187
Second Contract Year	27707

## EXHIBIT E

### START-UP TESTING

Required factory testing includes such checks and tests necessary to determine that the equipment systems and subsystems have been properly manufactured and installed, function properly, and are in a condition to permit safe and efficient start-up of the Facility, which may include but are not limited to (as applicable): **[Seller identify appropriate tests]**

1. Pressure tests of all steam system equipment;
2. Calibration of all pressure, level, flow, temperature and monitoring instruments;
3. Operating tests of all valves, operators, motor starters and motor;
4. Alarms, signals, and fail-safe or system shutdown control tests;
5. Insulation resistance and point-to-point continuity tests;
6. Bench tests of all protective devices;
7. Tests required by manufacturer of equipment; and
8. Complete pre-parallel checks with PacifiCorp.

Required start-up tests are those checks and tests necessary to determine that all features and equipment, systems, and subsystems have been properly designed, manufactured, installed and adjusted, function properly, and are capable of operating simultaneously in such condition that the Facility is capable of continuous delivery into PacifiCorp's electrical system, which may include but are not limited to (as applicable):

1. Turbine/generator mechanical runs including shaft, vibration, and bearing temperature measurements;
2. Running tests to establish tolerances and inspections for final adjustment of bearings, shaft run-outs;
3. Brake tests;
4. Energization of transformers;
5. Synchronizing tests (manual and auto);
6. Stator windings dielectric test;
7. Armature and field windings resistance tests;
8. Load rejection tests in incremental stages from 5, 25, 50, 75 and 100 percent load;
9. Heat runs;
10. Tests required by manufacturer of equipment;
11. Excitation and voltage regulation operation tests;
12. Open circuit and short circuit; saturation tests;
13. Governor system steady state stability test;
14. Phase angle and magnitude of all PT and CT secondary voltages and currents to protective relays, indicating instruments and metering;
15. Auto stop/start sequence;
16. Level control system tests; and
17. Completion of all state and federal environmental testing requirements.

**EXHIBIT F**

**Seller Authorization to Release Generation Data to PacifiCorp**

*[Interconnection Customer Letterhead]*

Transmission Services  
Attn: Director, Transmission Services  
825 NE Multnomah, Suite 1600  
Portland, OR 97232

**RE: Four Corners Windfarm, LLC Interconnection Request**

Dear Sir:

Four Corners Windfarm, LLC hereby voluntarily authorizes PacifiCorp's Transmission business unit to share Four Corners Windfarm, LLC 's generator interconnection information and generator meter data with Marketing Affiliate employees of PacifiCorp Energy, including, but not limited to those in the Commercial and Trading group. Four Corners Windfarm, LLC acknowledges that PacifiCorp did not provide it any preferences, either operational or rate-related, in exchange for this voluntary consent.

Richard S. Jell

Name

Manager, Utility Relations and Regulatory Compliance

Title FOUR CORNERS WINDFARM, LLC

June 16, 2009

Date



**EXHIBIT G**  
**SCHEDULE 37 and PRICING SUMMARY TABLE**

**PACIFIC POWER & LIGHT COMPANY  
AVOIDED COST PURCHASES FROM QUALIFYING  
FACILITIES OF 10,000 KW OR LESS**

**OREGON  
SCHEDULE 37  
Page 1**

**Available**

To owners of Qualifying Facilities making sales of electricity to the Company in the State of Oregon.

**Applicable**

For power purchased from Qualifying Facilities with a nameplate capacity of 10,000 kW or less or that, together with any other electric generating facility using the same motive force, owned or controlled by the same person(s) or affiliated person(s), and located at the same site, has a nameplate capacity of 10,000 kW or less. Owners of these Qualifying Facilities will be required to enter into a written power sales contract with the Company.

**Definitions**

**Cogeneration Facility**

A facility which produces electric energy together with steam or other form of useful energy (such as heat) which are used for industrial, commercial, heating or cooling purposes through the sequential use of energy.

**Qualifying Facilities**

Qualifying cogeneration facilities or qualifying small power production facilities within the meaning of section 201 and 210 of the Public Utility Regulatory Policies Act of 1978 (PURPA), 16 U.S.C. 796 and 824a-3.

**Small Power Production Facility**

A facility which produces electric energy using as a primary energy source biomass, waste, renewable resources or any combination thereof and has a power production capacity which, together with other facilities located at the same site, is not greater than 80 megawatts.

**On-Peak Hours or Peak Hours**

On-peak hours are defined as 6:00 a.m. to 10:00 p.m. Pacific Prevailing Time Monday through Saturday, excluding NERC holidays.

Due to the expansions of Daylight Saving Time (DST) as adopted under Section 110 of the U.S. Energy Policy Act of 2005, the time periods shown above will begin and end one hour later for the period between the second Sunday in March and the first Sunday in April and for the period between the last Sunday in October and the first Sunday in November.

**Off-Peak Hours**

All hours other than On-Peak.

**West Side Gas Market Index**

The monthly indexed gas price shall be the average of the price indexes published by Platts in "Inside FERC's Gas Market Report" monthly price report for Northwest Pipeline Corp. Rock Mountains, Northwest Pipeline Corp. Canadian Border, and Rockies/Northwest Stanfield, OR.

**Excess Output**

Excess output shall mean any increment of Net Output delivered at a rate, on an hourly basis, exceeding the Facility Nameplate Capacity. PacifiCorp shall pay Seller the Off-peak Price as described and calculated under pricing option 5 for all Excess Output.

(Continued)

---

Issued:	October 20, 2008	P.U.C. OR No. 35
Effective:	With service rendered on and after November 5, 2007	Seventh Revision of Sheet No. 37-1 Canceling Sixth Revision of Sheet No. 37-1

Issued By  
Andrea L. Kelly, Vice President, Regulation

**PACIFIC POWER & LIGHT COMPANY  
AVOIDED COST PURCHASES FROM QUALIFYING  
FACILITIES OF 10,000 KW OR LESS**

**Same Site**

Generating facilities are considered to be located at the same site as the QF for which qualification for the standard rates and standard contract is sought if they are located within a five-mile radius of any generating facilities or equipment providing fuel or motive force associated with the QF for which qualification for the standard rates and standard contract is sought.

**Person(s) or Affiliated Person(s):**

A natural person or persons or any legal entity or entities sharing common ownership, management or acting jointly or in concert with or exercising influence over the policies or actions of another person or entity. Two facilities will not be held to be owned or controlled by the same person(s) or affiliated person(s) solely because they are developed by a single entity. Two facilities will not be held to be owned or controlled by the same person(s) or affiliated person(s) if such common person or persons is a "passive investor" whose ownership interest in the QF is primarily related to utilizing production tax credits, green tag values and MACRS depreciation as the primary ownership benefit. A unit of Oregon local government may also be a "passive investor" if the local governmental unit demonstrates that it will not have an equity ownership interest in or exercise any control over the management of the QF and that its only interest is a share of the cash flow from the QF, which share will not exceed 20%. The 20% cash flow share limit may only be exceeded for good cause shown and only with the prior approval of the Commission.

**Shared Interconnection and Infrastructure:**

QFs otherwise meeting the separate ownership test and thereby qualified for entitlement to the standard rates and standard contract will not be disqualified by utilizing an interconnection or other infrastructure not providing motive force or fuel that is shared with other QFs qualifying for the standard rates and standard contract so long as the use of the shared interconnection complies with the interconnecting utility's safety and reliability standards, interconnection contract requirements and Prudent Electrical Practices as that term is defined in the interconnecting utility's approved standard contract.

**Dispute Resolution:**

Upon request, the QF will provide the purchasing utility with documentation verifying the ownership, management and financial structure of the QF in reasonably sufficient detail to allow the utility to make an initial determination of whether or not the QF meets the above-described criteria for entitlement to the standard rates and standard contract. Any dispute concerning a QF's entitlement to the standard rates and standard contract shall be presented to the Commission for resolution.

(Continued)

---

Issued:	April 12, 2007	P.U.C. OR No. 35
Effective:	With service rendered on and after April 13, 2007	First Revision of Sheet No. 37-2 Canceling Original Sheet No. 37-2

Issued By  
Andrea L. Kelly, Vice President, Regulation

**PACIFIC POWER & LIGHT COMPANY  
AVOIDED COST PURCHASES FROM QUALIFYING  
FACILITIES OF 10,000 KW OR LESS**

**Self Supply Option**

Owner shall elect to sell all Net Output to PacifiCorp and purchase its full electric requirements from PacifiCorp or sell Net Output surplus to its needs at the Facility site to PacifiCorp and purchase partial electric requirements service from PacifiCorp, in accordance with the terms and conditions of the power purchase agreement and the appropriate retail service.

**Pricing Options**

**1. Fixed Avoided Cost Prices**

Prices are fixed at the time that the contract is signed by both the Qualifying Facility and the Company and will not change during the term of the contract. Fixed Avoided Cost Prices are available for a contract term of up to 15 years and prices under a longer term contract (up to 20 years) will thereafter be under either the Firm Electric Index, the Banded Gas Market Indexed Avoided Cost Prices or the Gas Market Indexed Avoided Cost Prices.

**2. Gas Market Indexed Avoided Cost Prices**

Fixed prices apply during the resource sufficiency period (2007 through 2011), thereafter a portion of avoided cost prices are indexed to actual monthly West Side Gas Market Index prices. The remaining portion of avoided cost prices will be fixed at the time that the contract is signed by both the Qualifying Facility and the Company and will not change during the term of the contract. Prices are available for a term of up to 20 years.

**3. Banded Gas Market Indexed Avoided Cost Prices**

Fixed prices apply during the resource sufficiency period (2007 through 2011), thereafter a portion of avoided cost prices are indexed to actual monthly West Side Gas Market Index prices. The remaining portion of avoided cost prices will be fixed at the time that the contract is signed by both the Qualifying Facility and the Company and will not change during the term of the contract. The gas indexed portion of the avoided cost prices are banded to limit the amount that prices can vary with changes in gas prices. Prices are available for a term of up to 20 years.

**4. Firm Market Indexed Avoided Cost Prices**

Firm market index avoided cost prices are available to Qualifying Facilities that contract to deliver firm power. Monthly on-peak / off-peak prices paid are a blending of Dow Jones Index Firm day-ahead Mid-Columbia, California Oregon Border (COB), Four Corners and Palo Verde on-peak and off-peak prices. The monthly blending matrix is available upon request.

**5. Non-firm Market Index Avoided Cost Prices**

Non- Firm market index avoided cost prices are available to Qualifying Facilities that do not elect to provide firm power. Qualifying Facilities taking this option will have contracts that do not include minimum delivery requirements, default damages for construction delay, for under delivery or early termination, or default security for these purposes. Monthly On-Peak / Off-Peak prices paid are a blending of Dow Jones Index Non-firm day-ahead Mid-Columbia, California Oregon Border (COB), Four Corners and Palo Verde on-peak and off-peak prices. The monthly blending matrix is available upon request.

(Continued)

---

Issued:	October 20, 2008	P.U.C. OR No. 35
Effective:	With service rendered on and after September 26, 2008	Sixth Revision of Sheet No. 37-3 Canceling Fifth Revision of Sheet No. 37-3

Issued By  
Andrea L. Kelly, Vice President, Regulation

**PACIFIC POWER & LIGHT COMPANY  
AVOIDED COST PURCHASES FROM QUALIFYING  
FACILITIES OF 10,000 KW OR LESS**

**OREGON  
SCHEDULE 37  
Page 4**

---

**Monthly Payments**

A Qualifying Facility shall select the option of payment at the time of signing the contract under one of three Pricing Options as specified above. Once an option is selected the option will remain in effect for the duration of the Facility's contract.

**Fixed Avoided Cost Prices**

In accordance with the terms of a contract with a Qualifying Facility, the Company shall pay for all separately metered kilowatt-hours of On-Peak and Off-Peak generation at the fixed prices as provided in this tariff. The definition of On-Peak and Off-Peak is as defined in the definitions section of this tariff.

**Gas Market Indexed Avoided Cost Prices**

In accordance with the terms of a contract with a Qualifying Facility, the Company shall pay for all separately metered kilowatt-hours of On-Peak and Off-Peak generation at On-Peak and Off-Peak prices calculated each month.

To calculate the Off-Peak price, multiply the West Side Gas Market Index price in \$/MMBtu by 0.727 to get actual gas price in cents/kWh. The Off-Peak Energy Adder is added to the actual gas price to get the Off-Peak Price.

The On-Peak price is the Off-Peak price plus the On-Peak Capacity Adder.

**Banded Gas Indexed Avoided Cost Prices**

In accordance with the terms of a contract with a Qualifying Facility, the Company shall pay for all separately metered kilowatt-hours of On-Peak and Off-Peak generation at On-Peak and Off-Peak prices calculated each month.

To calculate the Off-Peak price, multiply the West Side Gas Market Index price in \$/MMBtu by 0.727 to get actual gas price in cents/kWh. This price is banded such that the actual gas price shall be no lower than the Gas Market Index Floor nor greater than the Gas Market Index Ceiling as listed in the price section of this tariff. The Off-Peak Energy Adder is added to the actual gas price to get the Off-Peak Price.

The On-Peak price is the Off-Peak price plus the On-Peak Capacity Adder.

**Firm Market Indexed and Non-firm Market Index Avoided Cost Prices**

In accordance with the terms of a contract with a Qualifying Facility, the Company shall pay for all separately metered kilowatt-hours of On-Peak and Off-Peak generation at the market prices calculated at the time of delivery. The definition of On-Peak and Off-Peak is as defined in the definitions section of this tariff.

(Continued)

---

Issued:	October 20, 2008	P.U.C. OR No. 35
Effective:	With service rendered on and after November 5, 2007	Fourth Revision of Sheet No. 37-4 Canceling Third Revision of Sheet No. 37-4

Issued By  
Andrea L. Kelly, Vice President, Regulation

**PACIFIC POWER & LIGHT COMPANY**  
**AVOIDED COST PURCHASES FROM QUALIFYING**  
**FACILITIES OF 10,000 KW OR LESS**

**Avoided Cost Prices**

**Pricing Option 1 – Fixed Avoided cost Prices ¢/kWh**

Deliveries During Calendar Year	On-Peak Energy Price	Off-Peak Energy Price
	(a)	(b)
2007	6.65	5.56
2008	7.06	5.70
2009	7.11	5.62
2010	7.21	5.59
2011	7.16	5.42
2012	7.68	5.86
2013	7.72	5.86
2014	7.95	6.06
2015	8.25	6.32
2016	8.40	6.44
2017	8.55	6.55
2018	8.69	6.66
2019	8.86	6.78
2020	9.03	6.91
2021	9.01	6.86
2022	9.03	6.83
2023	9.06	6.82

(Continued)

Issued: October 20, 2008  
Effective: With service rendered on and after  
November 5, 2007

P.U.C. OR No. 35  
Fourth Revision of Sheet No. 37-5  
Canceling Third Revision of Sheet No. 37-5

Issued By

Andrea L. Kelly, Vice President, Regulation

**PACIFIC POWER & LIGHT COMPANY**  
**AVOIDED COST PURCHASES FROM QUALIFYING**  
**FACILITIES OF 10,000 KW OR LESS**

**Avoided Cost Prices (Continued)**

**Pricing Option 2 – Gas Market Indexed Avoided Cost Prices €/kWh**

Deliveries During Calendar Year	Fixed Prices		Gas Market Index		Forecast	Estimated Prices (3)	
	On-Peak	Off-Peak	On-Peak	Off-Peak	West Side Gas Market Index Price (2)	On-Peak	Off-Peak
	Energy	Energy	Capacity	Energy		Energy	Energy
	Price	Price	Adder (1)	Adder	\$/MMBtu	Price	Price
(a)	(b)	(c)	(d)	(e)	(f)	(g)	
			Avoided Firm Capacity Costs / (0.876 * 85.4% * 57%)	Total Avoided Energy Costs - ((e) * 0.727)		(g) + (c)	((e) * 0.727) + (d)
2007	6.65	5.56					
2008	7.06	5.70					
2009	7.11	5.62					
2010	7.21	5.59					
2011	7.16	5.42					
2012			1.82	0.50	\$7.37	7.68	5.86
2013			1.85	0.51	\$7.36	7.72	5.86
2014			1.89	0.52	\$7.62	7.95	6.06
2015			1.93	0.54	\$7.96	8.25	6.32
2016			1.96	0.55	\$8.10	8.40	6.44
2017			2.00	0.56	\$8.24	8.55	6.55
2018			2.04	0.56	\$8.38	8.69	6.66
2019			2.08	0.57	\$8.54	8.86	6.78
2020			2.12	0.59	\$8.70	9.03	6.91
2021			2.16	0.59	\$8.62	9.01	6.86
2022			2.20	0.61	\$8.56	9.03	6.83
2023			2.24	0.61	\$8.54	9.06	6.82
2024			2.28	0.62	\$8.45	9.04	6.76
2025			2.32	0.63	\$8.38	9.04	6.72
2026			2.37	0.64	\$8.30	9.04	6.67
2027			2.41	0.65	\$8.32	9.11	6.70
2028			2.46	0.66	\$8.38	9.21	6.75

(1) Avoided Firm Capacity Costs are equal to the fixed costs of a SCCT as identified in the Company's 2007 IRP.

(2) A heat rate of 0.727 is used to adjust gas prices from \$/MMBtu to €/kWh

(3) Estimated avoided cost prices based upon forecast West Side Gas Market Index prices.

Actual prices will be calculated each month using actual index gas prices.

(Continued)

Issued:	October 20, 2008	P.U.C. OR No. 35
Effective:	With service rendered on and after November 5, 2007	Fourth Revision of Sheet No. 37-6 Canceling Third Revision of Sheet No. 37-6

Issued By  
 Andrea L. Kelly, Vice President, Regulation

**PACIFIC POWER & LIGHT COMPANY**  
**AVOIDED COST PURCHASES FROM QUALIFYING**  
**FACILITIES OF 10,000 KW OR LESS**

**OREGON**  
**SCHEDULE 37**  
 Page 7

**Avoided Cost Prices (Continued)**  
**Pricing Option 3 – Banded Gas Market Indexed Avoided Cost Prices \$/kWh**

Deliveries During Calendar Year	Fixed Prices		Banded Gas Market Index				Forecast	Estimated Prices (3)	
	On-Peak	Off-Peak	On-Peak	Off-Peak	Gas Market Index		West Side Gas Market Index Price (2)	On-Peak	Off-Peak
	Energy	Energy	Capacity	Energy	Floor	Ceiling		Energy	Energy
	Price	Price	Adder (1)	Adder	90%	110%	\$/MMBtu	Price	Price
(a)	(b)	(c)	(d)	(e)	(f)	(g)	(h)	(i)	
			Avoided Firm Capacity Costs / (0.876 * 85.4% * 57%)	Total Avoided Energy Costs - ((c) * 0.727)	(g) * 0.727 * 90%	(g) * 0.727 * 110%		(i) + (c)	MIN(MAX(((g) * 0.727), (e)), (f)) + (d)
2007	6.65	5.56							
2008	7.06	5.70							
2009	7.11	5.62							
2010	7.21	5.59							
2011	7.16	5.42							
2012			1.82	0.50	4.82	5.89	\$7.37	7.68	5.86
2013			1.85	0.51	4.82	5.89	\$7.36	7.72	5.86
2014			1.89	0.52	4.99	6.09	\$7.62	7.95	6.06
2015			1.93	0.54	5.21	6.37	\$7.96	8.25	6.32
2016			1.96	0.55	5.30	6.48	\$8.10	8.40	6.44
2017			2.00	0.56	5.39	6.59	\$8.24	8.55	6.55
2018			2.04	0.56	5.48	6.70	\$8.38	8.69	6.66
2019			2.08	0.57	5.59	6.83	\$8.54	8.86	6.78
2020			2.12	0.59	5.69	6.96	\$8.70	9.03	6.91
2021			2.16	0.59	5.64	6.89	\$8.62	9.01	6.86
2022			2.20	0.61	5.60	6.85	\$8.56	9.03	6.83
2023			2.24	0.61	5.59	6.83	\$8.54	9.06	6.82
2024			2.28	0.62	5.53	6.76	\$8.45	9.04	6.76
2025			2.32	0.63	5.48	6.70	\$8.38	9.04	6.72
2026			2.37	0.64	5.43	6.64	\$8.30	9.04	6.67
2027			2.41	0.65	5.44	6.65	\$8.32	9.11	6.69
2028			2.46	0.66	5.48	6.70	\$8.38	9.21	6.75

- (1) Avoided Firm Capacity Costs are equal to the fixed costs of a SCCT as identified in the Company's 2007 IRP.
- (2) A heat rate of 0.727 is used to adjust gas prices from \$/MMBtu to \$/kWh
- (3) Estimated avoided cost prices based upon forecast West Side Gas Market Index prices.  
Actual prices will be calculated each month using actual index gas prices.

(Continued)

Issued: October 20, 2008 P.U.C. OR No. 35  
 Effective: With service rendered on and after November 5, 2007 Fourth Revision of Sheet No. 37-7  
 Canceling Third Revision of Sheet No. 37-7

Issued By  
 Andrea L. Kelly, Vice President, Regulation



---

**Example of Gas Pricing Options available to the Qualifying Facility**

An example of the two gas pricing options using different assumed gas prices is provided at the end of this tariff.

**Qualifying Facilities Contracting Procedure**

Interconnection and power purchase agreements are handled by different functions within the Company. Interconnection agreements (both transmission and distribution level voltages) are handled by the Company's transmission function (PacifiCorp Transmission Services) while power purchase agreements are handled by the Company's merchant function (PacifiCorp Commercial and Trading).

It is recommended that the owner initiate its request for interconnection 18 months ahead of the anticipated in-service date to allow time for studies, negotiation of agreements, engineering, procurement, and construction of the required interconnection facilities. Early application for interconnection will help ensure that necessary interconnection arrangements proceed in a timely manner on a parallel track with negotiation of the power purchase agreement.

**1. Qualifying Facilities up to 10,000 kW**

**APPLICATION:** To owners of existing or proposed QFs with a design capacity less than or equal to 10,000 kW who desire to make sales to the Company in the state of Oregon. Such owners will be required to enter into a written power purchase agreement with the Company pursuant to the procedures set forth below.

**I. Process for Completing a Power Purchase Agreement**

**A. Communications**

Unless otherwise directed by the Company, all communications to the Company regarding QF power purchase agreements should be directed in writing as follows:

Pacific Power & Light Company  
Manager-QF Contracts  
825 NE Multnomah St, Suite 600  
Portland, Oregon 97232

The Company will respond to all such communications in a timely manner. If the Company is unable to respond on the basis of incomplete or missing information from the QF owner, the Company shall indicate what additional information is required. Thereafter, the Company will respond in a timely manner following receipt of all required information.

**B. Procedures**

1. The Company's approved generic or standard form power purchase agreements may be obtained from the Company's website at [www.pacificorp.com](http://www.pacificorp.com), or if the owner is unable to obtain it from the website, the Company will send a copy within seven days of a written request.
2. In order to obtain a project specific draft power purchase agreement the owner must provide in writing to the Company, general project information required for the completion of a power purchase agreement, including, but not limited to:
  - (a) demonstration of ability to obtain QF status;  
(Continued)

---

Issued:	October 20, 2008	P.U.C. OR No. 35
Effective:	With service rendered on and after November 5, 2007	Second Revision of Sheet No. 37-8 Canceling Original Sheet No. 37-8

Issued By  
Andrea L. Kelly, Vice President, Regulation

**PACIFIC POWER & LIGHT COMPANY  
AVOIDED COST PURCHASES FROM QUALIFYING  
FACILITIES OF 10,000 KW OR LESS**

**B. Procedures (Continued)**

- b) design capacity (MW), station service requirements, and net amount of power to be delivered to the Company's electric system;
  - c) generation technology and other related technology applicable to the site;
  - d) proposed site location;
  - e) schedule of monthly power deliveries;
  - f) calculation or determination of minimum and maximum annual deliveries;
  - g) motive force or fuel plan;
  - h) proposed on-line date and other significant dates required to complete the milestones;
  - i) proposed contract term and pricing provisions (i.e., fixed, deadband, gas indexed);
  - j) status of interconnection or transmission arrangements;
  - k) point of delivery or interconnection;
3. The Company shall provide a draft power purchase agreement when all information described in Paragraph 2 above has been received in writing from the QF owner. Within 15 business days following receipt of all information required in Paragraph 2, the Company will provide the owner with a draft power purchase agreement including current standard avoided cost prices and/or other optional pricing mechanisms as approved by the Oregon Public Utilities Commission in this Schedule 37.
4. If the owner desires to proceed with the power purchase agreement after reviewing the Company's draft power purchase agreement, it may request in writing that the Company prepare a final draft power purchase agreement. In connection with such request, the owner must provide the Company with any additional or clarified project information that the Company reasonably determines to be necessary for the preparation of a final draft power purchase agreement. Within 15 business days following receipt of all information requested by the Company in this paragraph 4, the Company will provide the owner with a final draft power purchase agreement.
5. After reviewing the final draft power purchase agreement, the owner may either prepare another set of written comments and proposals or approve the final draft power purchase agreement. If the owner prepares written comments and proposals the Company will respond in 15 business days to those comments and proposals.
6. When both parties are in full agreement as to all terms and conditions of the draft power purchase agreement, the Company will prepare and forward to the owner within 15 business days, a final executable version of the agreement. Following the Company's execution a completely executed copy will be returned to the owner. Prices and other terms and conditions in the power purchase agreement will not be final and binding until the power purchase agreement has been executed by both parties.

(Continued)

---

Issued:	October 20, 2008	P.U.C. OR No. 35
Effective:	With service rendered on and after November 5, 2007	Second Revision of Sheet No. 37-9 Canceling First Revision of Sheet No. 37-9

Issued By  
Andrea L. Kelly, Vice President, Regulation

---

**II. Process for Negotiating Interconnection Agreements**

[NOTE: Section II applies only to QFs connecting directly to PacifiCorp's electrical system. An off-system QF should contact its local utility or transmission provider to determine the interconnection requirements and wheeling arrangement necessary to move the power to PacifiCorp's system.]

In addition to negotiating a power purchase agreement, QFs intending to make sales to the Company are also required to enter into an interconnection agreement that governs the physical interconnection of the project to the Company's transmission or distribution system. The Company's obligation to make purchases from a QF is conditioned upon the QF completing all necessary interconnection arrangements. It is recommended that the owner initiate its request for interconnection 18 months ahead of the anticipated in-service date to help ensure that necessary interconnection arrangements proceed in a timely manner on a parallel track with negotiation of the power purchase agreement.

Because of functional separation requirements mandated by the Federal Energy Regulatory Commission, interconnection and power purchase agreements are handled by different functions within the Company. Interconnection agreements (both transmission and distribution level voltages) are handled by the Company's transmission function (including but not limited to PacifiCorp Transmission Services) while power purchase agreements are handled by the Company's merchant function (including but not limited to PacifiCorp's Commercial and Trading Group).

**A. Communications**

Initial communications regarding interconnection agreements should be directed to the Company in writing as follows:

PacifiCorp  
Director – Transmission Services  
825 NE Multnomah St, Suite 1600  
Portland, Oregon 97232

Based on the project size and other characteristics, the Company will direct the QF owner to the appropriate individual within the Company's transmission function who will be responsible for negotiating the interconnection agreement with the QF owner. Thereafter, the QF owner should direct all communications regarding interconnection agreements to the designated individual, with a copy of any written communications to the address set forth above.

**B. Procedures**

Generally, the interconnection process involves (1) initiating a request for interconnection, (2) undertaking studies to determine the system impacts associated with the interconnection and the design, cost, and schedules for constructing any necessary interconnection facilities, and (3) executing an interconnection agreement to address facility construction, testing, acceptance, ownership, operation and maintenance issues. Consistent with PURPA and Oregon Public Utility Commission regulations, the owner is responsible for all interconnection costs assessed by the Company on a nondiscriminatory basis. For interconnections impacting the Company's Transmission and Distribution System, the Company will process the interconnection application through PacifiCorp Transmission Services.

(Continued)

---

Issued:	October 20, 2008	P.U.C. OR No. 35
Effective:	With service rendered on and after November 5, 2007	Second Revision of Sheet No. 37-10 Canceling First Revision of Sheet No. 37-10

Issued By  
Andrea L. Kelly, Vice President, Regulation

**PACIFIC POWER & LIGHT COMPANY**  
**AVOIDED COST PURCHASES FROM QUALIFYING**  
**FACILITIES OF 10,000 KW OR LESS**

**OREGON**  
**SCHEDULE 37**  
 Page 11

**Example of Gas Pricing Options given Assumed Gas Prices ¢/kWh**

Banded Gas Market Index												
Year	Prices Listed in the Tariff				Example using assumed Gas Prices						Compared to Fixed Prices	
	On-Peak Capacity Adder	Off-Peak Energy Adder	Gas Market Index		Assumed Gas Price \$/MMBtu	Actual Energy Price	Fuel Index		Price Paid to QF		Off-Peak Price	On-Peak Price
			Floor 90%	Ceiling 110%			Floor / Ceiling Component	Type of Price	Off-Peak Price	On-Peak Price		
(a)	(b)	(c)	(d)	(e)	(f) (a) x 0.727	(g)	(h)	(i) (b) - (g)	(j) (a) - (f)	(k)	(l)	
2012	1.82	0.50	4.82	5.89	\$5.00	3.64	4.82	Floor	5.32	7.14	5.86	7.68
					\$6.00	4.36	4.82	Floor	5.32	7.14		
					\$7.00	5.09	5.09	Actual	5.59	7.41		
					\$10.00	7.27	5.89	Ceiling	6.39	8.21		
					\$12.00	8.72	5.89	Ceiling	6.39	8.21		

Gas Market Method												
Year	Prices Listed in the Tariff				Example using assumed Gas Prices						Compared to Fixed Prices	
	On-Peak Capacity Adder	Off-Peak Energy Adder	Fuel Index		Assumed Gas Price \$/MMBtu	Actual Energy Price	Fuel Index		Price Paid to QF		Off-Peak Price	On-Peak Price
			Floor 90%	Ceiling 110%			Floor / Ceiling Component	Type of Price	Off-Peak Price	On-Peak Price		
(a)	(b)	(c)	(d)	(e)	(f) (a) x 0.727	(g)	(h)	(i) (b) - (g)	(j) (a) - (f)	(k)	(l)	
2012	1.82	0.50	Not Relevant		\$5.00	3.64			4.14	5.96	5.86	7.72
					\$6.00	4.36			4.86	6.68		
					\$7.00	5.09		Not Relevant	5.59	7.41		
					\$10.00	7.27			7.77	9.59		
					\$12.00	8.72			9.22	11.04		

Issued: October 20, 2008  
 Effective: With service rendered on and after November 5, 2007

P.U.C. OR No. 35  
 First Revision of Sheet No. 37-11  
 Canceling Original Sheet No. 37-11

Issued By  
 Andrea L. Kelly, Vice President, Regulation

## ADDENDUM L

### STATION LOAD, LOSSES, and NET OUTPUT ALLOCATION ALGORITHM for the Morrow Projects

This Addendum L is hereby made a part of, and clarifies certain terms in, the thirteen Oregon Standard Firm Qualifying Facility Power Purchase Agreements for Intermittent Resources 10 MW or Less (the "PPAs") entered into between each of the Morrow Projects and PacifiCorp (d/b/a Pacific Power), an Oregon corporation, acting in its regulated utility capacity ("PacifiCorp").

Nine Oregon limited liability companies (Sand Ranch Windfarm, LLC; Oregon Trail Windfarm, LLC; Ward Butte Windfarm, LLC; Pacific Canyon Windfarm, LLC; Four Mile Canyon Windfarm, LLC; Four Corners Windfarm, LLC; Big Top, LLC; Butter Creek Power, LLC; and Wagon Trail, LLC) (collectively "**Echo Projects**"), each own wind powered electric generation facilities which together comprise a complex of nine separate, Oregon standard wind Qualifying Facilities, that share collector wires, and the Echo Projects 34.5/69 kV substation ("**Echo Collection Facilities**").

Four Oregon limited liability companies (Lower Ridge Windfarm, LLC; High Plateau Windfarm, LLC; Mule Hollow Windfarm, LLC; and Pine City Windfarm, LLC) (collectively "**Butter Creek Projects**"), each own wind powered electric generation facilities which together comprise a complex of four separate, Oregon standard wind Qualifying Facilities, that share collector wires, and the Butter Creek Projects 34.5/69 kV substation ("**Butter Creek Collection Facilities**").

Together the Echo Projects and the Butter Creek Projects comprise the "**Morrow Projects**", which share a 69 kV line, and related equipment ("**Shared Interconnection Facilities**"), which connect the Echo Projects substation and the Butter Creek Projects substation to the Point of Delivery. Each of the Morrow Projects and PacifiCorp are referred to herein individually as a "**Party**" or collectively as the "**Parties**".

The Echo Projects entered into PPAs with PacifiCorp between December 19, 2008 and June 19, 2009. This Addendum L supersedes and replaces each Addendum L to such Echo Projects' PPAs. The Butter Creek Projects are entering or have entered into PPAs with PacifiCorp on or about November 18, 2011. This Addendum L is hereby made a part each of the Butter Creek Projects' PPA. The Butter Creek Projects intend to develop new Qualifying Facilities that will own and use a share of the Shared Interconnection Facilities. For purposes of this Addendum L, "**the Agreement**" means the single PPA to which this Addendum L is attached. Capitalized terms not defined in this Addendum L shall have the meaning set forth in the Agreement.

PacifiCorp has agreed to buy (and Seller has agreed to sell), at the Point of Delivery, Seller's total energy output net of: (1) Seller's station service and collection system losses; (2) energy provided by Seller to other Morrow Project(s) to supply their station service load and collection system losses; (3) Seller's share of the transformation losses ( items (1-3) together are Seller's "**Station Auxiliary Load and Losses**"); and (4) Seller's share of the losses on the Shared Interconnection Facilities. However, Seller and PacifiCorp agree that it is impossible to directly measure Seller's Station Auxiliary Load and Losses separate and apart from the Station Auxiliary Load and Losses of the other Morrow Projects. Therefore, in order to implement an objective, practicable, and equitable process by which PacifiCorp may quantify energy delivered by Seller to the Point of Delivery (net of its Station Auxiliary Load and Losses and its share of losses on the Shared Interconnection Facilities), and quantify the energy supplied to Seller at the Point of Delivery, the Parties do agree as follows:

**A. Utility Roles and Obligations**

The "**Utility Supplier(s)**" shall be the utility with the right (franchise) to provide retail electric service at the Facility (at the time this Addendum L becomes effective the Utility Supplier(s) are Umatilla Electric Co-op and or Columbia Basin Electric Co-op).

PacifiCorp shall own and maintain the metering at the Echo and Butter Creek substations and at the Point of Delivery and each month during the term of the Agreement, shall perform allocation calculations and electronically provide the results in table form to the Morrow Projects. The results of such calculations shall be used by PacifiCorp (in conjunction with the metered output of each individual Project) to determine Seller's Net Output in kWh and to enable the Utility Supplier(s) to render invoices for the energy supplied to the Morrow Projects to supply Station Auxiliary Load and Losses and line losses.

PacifiCorp shall have no obligation to serve any of the Morrow Projects' retail electric needs absent a separate written agreement with PacifiCorp and then only with the permission of Seller's Utility Supplier(s). Except as provided in this Addendum L, none of the costs associated with provision of retail electric service to Seller shall be borne by PacifiCorp.

Such calculations shall be based on the definitions and formulae below, with the raw data gathered from specified meters set to use a metering integration interval of 5, 10,15, or 60 minutes at PacifiCorp's election, to match the metering equipment installation PacifiCorp specified for the Morrow Projects ("**Allocation Interval**"). The Parties acknowledge that with the bi-directional metering at the Echo substation, at the Butter Creek substation, and at the Point of Delivery, it is possible for the Morrow Projects to sell Net Output and purchase retail energy during the same Allocation Interval.

## B. Billing Formulae

### 1. Definitions

$PALL_T$  = the accumulated energy purchased from Utility Supplier(s), during an Allocation Interval, as determined at the Point of Delivery, to supply the net total Station Auxiliary Load and Losses plus the losses on the Shared Interconnection Facilities for Morrow Projects  $i = 1$  to 13 whenever such total load and losses exceeds total generation output during such Allocation Interval.

$OP_i$  = the metered output energy of Morrow Project  $i$ , during an Allocation Interval, as determined by PacifiCorp's meter at the point where Morrow Project  $i$  connects to the Echo Collection Facilities or the Butter Creek Collection Facilities. For an Allocation Interval during which energy is supplied to a Project, such supplied energy is accumulated in a separate meter register and does not decrement the register used to measure accumulated  $OP_i$ . Therefore  $OP_i$  is by definition always greater than or equal to zero, and in the event the meter records  $OP_i$  less than zero,  $OP_i$  shall be deemed to equal zero.

$OP_{Echo}$  = the sum of  $OP_i$  for all Echo Projects.

$OP_{Butter}$  = the sum of  $OP_i$  for all Butter Creek Projects.

$NO_T$  = the total Net Output energy delivered to the Point of Delivery (69 kV Busbar of PacifiCorp's Hinkle substation) during an Allocation Interval.  $NO_T$  shall be as measured at PacifiCorp's meter near the Point of Delivery (kWh), adjusted for any transformation losses between the location of the metering measurement devices and the Point of Delivery. For any Allocation Interval during which Utility Suppliers supply energy to the Morrow Projects at the Point of Delivery, such supplied energy is accumulated in a separate meter register of the PacifiCorp meter at the Point of Delivery and does not decrement the register used to measure accumulated Net Output energy. Therefore  $NO_T$  is by definition always greater than or equal to zero and in the event the meter records  $NO_T$  less than zero,  $NO_T$  shall be deemed to equal zero.

$NO_{Echo}$  = the portion of  $NO_T$  attributable to the nine Echo Projects during an Allocation Interval.

$NO_{Butter}$  = the portion of  $NO_T$  attributable to the four Butter Creek Projects during an Allocation Interval.

$NO_i$  = the Net Output energy sold to PacifiCorp by Morrow Project  $i$  during an Allocation Interval.

- BDM = the total energy output delivered by the Butter Creek Projects at the Butter Creek substation during an Allocation Interval as measured by the PacifiCorp-owned bi-directional meter equipment located on the 69 kV side of the Butter Creek substation in kWh.
- BPM = the total energy used by the Butter Creek Projects at the Butter Creek substation during an Allocation Interval as measured by the PacifiCorp-owned bi-directional meter equipment located on the 69 kV side of the Butter Creek substation in kWh.
- EDM = the total energy output delivered by the Echo Projects at the Echo substation during an Allocation Interval as measured by the PacifiCorp-owned bi-directional meter equipment located on the 69 kV side of the Echo substation in kWh.
- EPM = the total energy used by the Echo Projects at the Echo substation during an Allocation Interval as measured by the PacifiCorp-owned bi-directional meter equipment located on the 69 kV side of the Echo substation in kWh.
- ELOSS = the share of the losses on the Shared Interconnection Facilities during an Allocation Interval deemed to be attributed to the Echo Projects generation of  $OP_{Echo}$  as determined by the formula in Section G of this Addendum L based on the concurrent value of EDM, which formula shall be subject to revision from time to time in accordance with Section G of this Addendum L. In the event  $OP_{Echo}$  is less than or equal to zero, ELOSS shall be deemed equal to zero in kWh.

## 2. Calculations

Calculations shall be reconciled and settled monthly. Calculations shall be rounded to the nearest kilowatt-hour in the final step.

(a). *When Total Generation Output at the Point of Delivery <= Total Station Auxiliary Load and Losses*

During an Allocation Interval, the contributions to the monthly billing determinants for the Echo Projects and the Butter Creek Projects purchases of energy from the Utility Supplier(s), to supply Station Auxiliary Load and Losses and any allocated shares of any associated losses on the Shared Interconnection Facilities, shall be determined with the following formulae:

Energy purchase monthly billing determinant contribution for the Echo Projects equals:

$$\text{Zero, in the event } PALL_T \text{ is equal to zero, and otherwise,} \\ EPM + [EPM / (EPM+BPM) * (PALL_T - EPM - BPM)]$$



Energy purchase monthly billing determinant contribution for the Butter Creek Projects equals:

$$\text{Zero, in the event } PALL_T \text{ is equal to zero, and otherwise} \\ \text{BPM} + [ \text{BPM} / (\text{EPM} + \text{BPM}) * (\text{PALL}_T - \text{EPM} - \text{BPM}) ]$$

(b). When Total Generation Output at the Point of Delivery > Total Station Auxiliary Load and Losses

During an Allocation Interval, the contributions to the monthly billing determinants for the Echo Projects and the Butter Creek Projects sale of Net Output to PacifiCorp shall be determined with the following formulae:

$$\text{NO}_{\text{Echo}} = \text{zero when EDM equals zero; and otherwise } \text{NO}_{\text{Echo}} = \text{the lesser of} \\ [ \text{EDM} - \text{ELOSS} ] \text{ and } [ \text{NO}_T ]; \text{ and}$$

$$\text{NO}_{\text{Butter}} = \text{zero when BDM equals zero; and otherwise } \text{NO}_{\text{Butter}} = [ \text{NO}_T - \text{NO}_{\text{Echo}} ];$$

For each Echo Project i:

$$\text{NO}_i = \text{NO}_{\text{Echo}} * [ \text{OP}_i / \text{OP}_{\text{Echo}} ]$$

For each Butter Creek Project i:

$$\text{NO}_i = \text{NO}_{\text{Butter}} * [ \text{OP}_i / \text{OP}_{\text{Butter}} ]$$

The Morrow Projects shall reconcile among themselves, as a matter independent of this Addendum L and the Agreement, any Allocation Intervals where EDM is zero and BDM is greater than zero, such that the Butter Creek Projects supplied the Station Auxiliary Load and Losses of the Echo Projects, EPM, resulting in a lesser  $\text{NO}_{\text{Butter}}$  or where where BDM is zero and EDM is greater than zero, such that the Echo Projects supplied the Station Auxiliary Load and Losses of the Butter Creek Projects, BPM, resulting in a lesser  $\text{NO}_{\text{Echo}}$  for such Allocation Intervals.

**C. Limitation of PacifiCorp Purchase Liability**

PacifiCorp's total purchase obligation to the Morrow Projects shall at no time exceed total energy delivered by the Morrow Projects to the Point of Delivery. Therefore, in the event the sum of the Net Output energy (calculated according to the preceding formulae) for all the Morrow Projects is greater than  $\text{NO}_T$ , then PacifiCorp shall reduce calculated Net Output energy from each Morrow Project, *pro rata* each Morrow Project's share of the  $\text{OP}_T$ , such that the total energy purchased from all the Morrow Projects at the Point of Delivery by PacifiCorp equals  $\text{NO}_T$ .

**D. PacifiCorp Right to Offset**

In the event PacifiCorp determines it has underpaid one or more Morrow Projects (due to metering error or otherwise) and, as a result of underpaying one or more Morrow Projects, has overpaid Seller, PacifiCorp may adjust Seller's future payment(s) accordingly in order to recapture any overpayment received by Seller in a reasonable time.

**E. Effective Date**

This Addendum L was negotiated jointly among the Morrow Projects and PacifiCorp, and each of the Morrow Projects' assent to Addendum L is essential to the purposes of this Addendum L. Therefore, this Addendum L shall not become effective until the first day of the first month after (1) all of the Morrow Projects have delivered to PacifiCorp an executed copy of Addendum L and PacifiCorp has executed same; and (2) all meters necessary to perform the calculations in Section 2 are operational ("**Addendum L Effective Date**").

**F. Recital E to the Power Purchase Agreement**

The Parties' intentionally left blank the elective options in Recital E to their PPAs because neither option describes the Parties' intent. The Parties intend that, when  $NO_T$  is greater than zero, Seller's full electric requirements will be served by its gross output or by the Net Output of other Morrow Projects. When  $NO_T$  is less than or equal to zero, Seller's full electric requirements at the Point of Delivery will be served by Seller's Utility Supplier.

**G. Echo Projects Shared Interconnection Facilities Loss Formula (ELOSS)**

During an Allocation Interval, the amount of the total losses (kWh) on the Shared Interconnection Facilities attributed to the output of the Echo Projects, ELOSS, shall be determined by the following formula:

$$ELOSS = (3\text{-phase EDM}/69)^2 * 1.1 / 1000$$

Where 3-phase EDM is the total energy delivered (kWh, measured at the Echo substation revenue meter) from the Echo Projects to the Echo substation during an Allocation Interval.

The Morrow Projects may, by unanimous agreement of the Morrow Projects, adjust the assumed loss formula (ELOSS) from time to time in order to more accurately approximate the line losses attributed to the generation from the Echo Projects on the Shared Interconnection Facilities in the absence of generation from the Butter Creek Projects. Any such adjustment may be communicated to PacifiCorp through the Morrow Project's duly authorized agent. Such adjustment(s) shall be effective for billing periods commencing 30 days after written notice of the adjustment to PacifiCorp. Adjustments to the ELOSS formula are subject to PacifiCorp's consent, which consent shall not be unreasonably withheld or delayed. Each Morrow Project at its request shall be entitled to all electronic records and data from the Morrow Projects at Hinkle and at the high-side meters located at the Echo Substation and the Butter Creek Substation.

**H. Additional Meters.** The cost to design install, and maintain meters at the 69kV side of the Echo substation and at the 69 kV side of the Butter Creek substation shall be paid by the Butter Creek Projects.

**I. Disclaimer; Limitation**

The Parties acknowledge that the allocation of shared losses provided herein was agreed to by all of the Morrow Projects and PacifiCorp. PacifiCorp makes no warranty that the shared losses allocated among the Echo Projects will be equal to, less than, or greater than the shared line losses allocated among the Echo Projects under their previous Addenda L. This Addendum L shall not make any Morrow Project a party to any of the PPAs other than the PPA that Morrow Project has executed with PacifiCorp.

**J. Counterparts**

This Addendum L may be executed in one or more duplicate counterparts, and when executed and delivered by all the Parties listed below, shall constitute a single binding agreement.

**K. Signatures**

The individuals executing this Addendum L warrant that they have full authority to execute this Addendum L on behalf of the entity for whom they are acting herein.

IN WITNESS WHEREOF, the Parties by their officers thereunto duly authorized, have duly executed this Addendum L as of the date(s) provided below.

PacifiCorp

By:  

Name: Bruce Griswold

Title: Director, QFs and  
Short-term Origination

Date: January 17, 2012

**ECHO CO-OWNERS:**

Sand Ranch Windfarm, LLC

By: M. Miller

Name: MAURICE MILLER

Title: manager, Columbia Windfarms, LLC  
its managing member

Date: 1/5/12

Oregon Trail Windfarm, LLC

By: M. Miller

Name: MAURICE MILLER

Title: manager, Columbia Windfarms, LLC  
its managing member

Date: 1/5/12

Ward Butte Windfarm, LLC

By: \_\_\_\_\_

Name: \_\_\_\_\_

Title: \_\_\_\_\_

Date: \_\_\_\_\_

Pacific Canyon Windfarm, LLC

By: \_\_\_\_\_

Name: \_\_\_\_\_

Title: \_\_\_\_\_

Date: \_\_\_\_\_

Four Mile Canyon Windfarm, LLC

By: \_\_\_\_\_

Name: \_\_\_\_\_

Title: \_\_\_\_\_

Date: \_\_\_\_\_

Four Corners Windfarm, LLC

By: \_\_\_\_\_

Name: \_\_\_\_\_

Title: \_\_\_\_\_

Date: \_\_\_\_\_

Bit Top, LLC

By: \_\_\_\_\_

Name: \_\_\_\_\_

Title: \_\_\_\_\_

Date: \_\_\_\_\_

Butter Creek Power, LLC

By: \_\_\_\_\_

Name: \_\_\_\_\_

Title: \_\_\_\_\_

Date: \_\_\_\_\_

Wagon Trail, LLC

By: \_\_\_\_\_

Name: \_\_\_\_\_

Title: \_\_\_\_\_

Date: \_\_\_\_\_

**ECHO CO-OWNERS:**

**Sand Ranch Windfarm, LLC**

By: \_\_\_\_\_  
Name: \_\_\_\_\_  
Title: \_\_\_\_\_  
Date: \_\_\_\_\_

**Oregon Trail Windfarm, LLC**

By: \_\_\_\_\_  
Name: \_\_\_\_\_  
Title: \_\_\_\_\_  
Date: \_\_\_\_\_

**Ward Butte Windfarm, LLC**

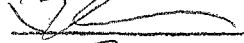
By:   
Name: Burgess Chan  
Title: Manager Pacific Trail Windfarm, LLC.  
Date: It's Managing Member 1/4/2012

**Pacific Canyon Windfarm, LLC**

By: \_\_\_\_\_  
Name: \_\_\_\_\_  
Title: \_\_\_\_\_  
Date: \_\_\_\_\_

**Four Mile Canyon Windfarm, LLC**

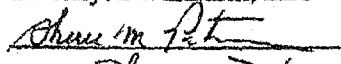
By:   
Name: Sherree M. Petrone  
Title: VP  
Date: 11/18/11

**Four Corners Windfarm, LLC**

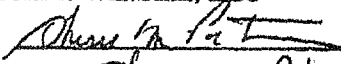
By:   
Name: Sherree M. Petrone  
Title: VP  
Date: 11/18/11

**Big Top, LLC**

By: \_\_\_\_\_  
Name: \_\_\_\_\_  
Title: \_\_\_\_\_  
Date: \_\_\_\_\_

**Butter Creek Power, LLC**

By: \_\_\_\_\_  
Name: \_\_\_\_\_  
Title: \_\_\_\_\_  
Date: \_\_\_\_\_

**Wagon Trail, LLC**

By: \_\_\_\_\_  
Name: \_\_\_\_\_  
Title: \_\_\_\_\_  
Date: \_\_\_\_\_

**ECHO CO-OWNERS:**

Sand Ranch Windfarm, LLC

By: \_\_\_\_\_  
Name: \_\_\_\_\_  
Title: \_\_\_\_\_  
Date: \_\_\_\_\_

Oregon Trail Windfarm, LLC

By: \_\_\_\_\_  
Name: \_\_\_\_\_  
Title: \_\_\_\_\_  
Date: \_\_\_\_\_

Ward Butte Windfarm, LLC

By: \_\_\_\_\_  
Name: \_\_\_\_\_  
Title: \_\_\_\_\_  
Date: \_\_\_\_\_

Pacific Canyon Windfarm, LLC

By: ~~\_\_\_\_\_~~  
Name: Robert Jaus  
Title: manager, Oregon Int'l Holdings, LLC  
Date: its managing member  
↳ 6 January 2012

Four Mile Canyon Windfarm, LLC

By: \_\_\_\_\_  
Name: \_\_\_\_\_  
Title: \_\_\_\_\_  
Date: \_\_\_\_\_

Four Corners Windfarm, LLC

By: \_\_\_\_\_  
Name: \_\_\_\_\_  
Title: \_\_\_\_\_  
Date: \_\_\_\_\_

Bit Top, LLC

By: \_\_\_\_\_  
Name: \_\_\_\_\_  
Title: \_\_\_\_\_  
Date: \_\_\_\_\_

Butter Creek Power, LLC

By: \_\_\_\_\_  
Name: \_\_\_\_\_  
Title: \_\_\_\_\_  
Date: \_\_\_\_\_

Wagon Trail, LLC

By: \_\_\_\_\_  
Name: \_\_\_\_\_  
Title: \_\_\_\_\_  
Date: \_\_\_\_\_

**ECHO CO-OWNERS:**

Sand Ranch Windfarm, LLC

By: \_\_\_\_\_  
Name: \_\_\_\_\_  
Title: \_\_\_\_\_  
Date: \_\_\_\_\_

Oregon Trail Windfarm, LLC

By: \_\_\_\_\_  
Name: \_\_\_\_\_  
Title: \_\_\_\_\_  
Date: \_\_\_\_\_

Ward Butte Windfarm, LLC

By: \_\_\_\_\_  
Name: \_\_\_\_\_  
Title: \_\_\_\_\_  
Date: \_\_\_\_\_

Pacific Canyon Windfarm, LLC

By: \_\_\_\_\_  
Name: \_\_\_\_\_  
Title: \_\_\_\_\_  
Date: \_\_\_\_\_

Four Mile Canyon Windfarm, LLC

By: Sherece M Petrone  
Name: Sherece M Petrone  
Title: VP  
Date: 11/18/11

Four Corners Windfarm, LLC

By: Sherece M Petrone  
Name: Sherece M Petrone  
Title: VP  
Date: 11/18/11

Big Top, LLC

By: \_\_\_\_\_  
Name: \_\_\_\_\_  
Title: \_\_\_\_\_  
Date: \_\_\_\_\_

Butter Creek Power, LLC

By: \_\_\_\_\_  
Name: \_\_\_\_\_  
Title: \_\_\_\_\_  
Date: \_\_\_\_\_

Wagon Trail, LLC

By: \_\_\_\_\_  
Name: \_\_\_\_\_  
Title: \_\_\_\_\_  
Date: \_\_\_\_\_

**ECHO CO-OWNERS:**

Sand Ranch Windfarm, LLC

By: \_\_\_\_\_  
Name: \_\_\_\_\_  
Title: \_\_\_\_\_  
Date: \_\_\_\_\_

Oregon Trail Windfarm, LLC

By: \_\_\_\_\_  
Name: \_\_\_\_\_  
Title: \_\_\_\_\_  
Date: \_\_\_\_\_

Ward Butte Windfarm, LLC

By: \_\_\_\_\_  
Name: \_\_\_\_\_  
Title: \_\_\_\_\_  
Date: \_\_\_\_\_

Pacific Canyon Windfarm, LLC

By: \_\_\_\_\_  
Name: \_\_\_\_\_  
Title: \_\_\_\_\_  
Date: \_\_\_\_\_

Four Mile Canyon Windfarm, LLC

By: \_\_\_\_\_  
Name: \_\_\_\_\_  
Title: \_\_\_\_\_  
Date: \_\_\_\_\_

Four Corners Windfarm, LLC

By: \_\_\_\_\_  
Name: \_\_\_\_\_  
Title: \_\_\_\_\_  
Date: \_\_\_\_\_

Bit Top, LLC

By: Frank Mader  
Name: Frank Mader  
Title: managing partner  
Date: 1-10-12

Butter Creek Power, LLC

By: \_\_\_\_\_  
Name: \_\_\_\_\_  
Title: \_\_\_\_\_  
Date: \_\_\_\_\_

Wagon Trail, LLC

By: Shannon Rust  
Name: Shannon Rust  
Title: managing member  
Date: Jan 10, 2012



**ECHO CO-OWNERS:**

Sand Ranch Windfarm, LLC

By: \_\_\_\_\_  
Name: \_\_\_\_\_  
Title: \_\_\_\_\_  
Date: \_\_\_\_\_

Oregon Trail Windfarm, LLC

By: \_\_\_\_\_  
Name: \_\_\_\_\_  
Title: \_\_\_\_\_  
Date: \_\_\_\_\_

Ward Butte Windfarm, LLC

By: \_\_\_\_\_  
Name: \_\_\_\_\_  
Title: \_\_\_\_\_  
Date: \_\_\_\_\_

Pacific Canyon Windfarm, LLC

By: \_\_\_\_\_  
Name: \_\_\_\_\_  
Title: \_\_\_\_\_  
Date: \_\_\_\_\_

Four Mile Canyon Windfarm, LLC

By: \_\_\_\_\_  
Name: \_\_\_\_\_  
Title: \_\_\_\_\_  
Date: \_\_\_\_\_

Four Corners Windfarm, LLC

By: \_\_\_\_\_  
Name: \_\_\_\_\_  
Title: \_\_\_\_\_  
Date: \_\_\_\_\_

Bit Top, LLC

By: \_\_\_\_\_  
Name: \_\_\_\_\_  
Title: \_\_\_\_\_  
Date: \_\_\_\_\_

Butter Creek Power, LLC

By:   
Name: Kent Madison  
Title: Managing Member  
Date: 1/5/12

Wagon Trail, LLC

By: \_\_\_\_\_  
Name: \_\_\_\_\_  
Title: \_\_\_\_\_  
Date: \_\_\_\_\_

