

POWER PURCHASE AGREEMENT

BETWEEN

OBSIDIAN RENEWABLES, LLC

**[a new Firm Qualifying Facility with 10,000 kW Facility Capacity Rating, or Less and
not an Intermittent Resource]**

AND

PACIFICORP

Section 1: Definitions	1
Section 2: Term; Commercial Operation Date	5
Section 3: Representations and Warranties.....	5
Section 4: Delivery of Power.....	8
Section 5: Purchase Prices	9
Section 6: Operation and Control	10
Section 7: Fuel/Motive Force	11
Section 8: Metering	11
Section 9: Billings, Computations, and Payments	12
Section 10: Security	12
Section 11: Defaults and Remedies	15
Section 12: Indemnification and Liability	18
Section 13: Insurance (<i>Facilities over 200kW only</i>)	19
Section 14: Force Majeure.....	20
Section 15: Several Obligations.....	21
Section 16: Choice of Law	21
Section 17: Partial Invalidation	21
Section 18: Waiver	21
Section 19: Governmental Jurisdictions and Authorizations.....	21
Section 20: Repeal of PURPA.....	22
Section 21: Successors and Assigns	22
Section 22: Entire Agreement.....	22
Section 23: Notices	22

POWER PURCHASE AGREEMENT

THIS POWER PURCHASE AGREEMENT, entered into this 30th day of July, 2014, is between Obsidian Renewables, LLC, "Seller" and PacifiCorp (d/b/a Pacific Power & Light Company), an Oregon corporation acting in its regulated utility capacity, "PacifiCorp." (Seller and PacifiCorp are referred to individually as a "Party" or collectively as the "Parties").

RECITALS

A. Seller intends to construct, own, operate and maintain the **Sprague River** solar photovoltaic facility for the generation of electric power, including interconnection facilities, located in near Sprague River, Klamath County, Oregon with a Facility Capacity Rating of 7,000 kilowatts (kW) as further described in **Exhibit A** and **Exhibit B** ("**Facility**"); and

B. Seller intends to commence delivery of Net Output under this Agreement, for the purpose of Start-up Testing, on December 1, 2016 ("**Scheduled Initial Delivery Date**"); and

C. Seller intends to operate the Facility as a Qualifying Facility, commencing commercial operations on December 31, 2016 ("**Scheduled Commercial Operation Date**"); and

D. Seller estimates that the average annual Net Energy to be delivered by the Facility to PacifiCorp is 17,518,000 kilowatt-hours (kWh), which amount of energy PacifiCorp will include in its resource planning; and

E. Seller shall (choose one) sell all Net Output to PacifiCorp and purchase its full electric requirements from PacifiCorp sell Net Output surplus to its needs at the Facility site to PacifiCorp and purchase partial electric requirements service from PacifiCorp, in accordance with the terms and conditions of this Agreement; and

F. This Agreement is a "New QF Contract" under the PacifiCorp Inter-Jurisdictional Cost Allocation Revised Protocol.

AGREEMENT

NOW, THEREFORE, the Parties mutually agree as follows:

SECTION 1: DEFINITIONS

When used in this Agreement, the following terms shall have the following meanings:

1.1 **"As-built Supplement"** shall be a supplement to **Exhibit A** and **Exhibit B**, provided by Seller following completion of construction of the Facility, describing the Facility as actually built.

1.2 **"Average Annual Generation"** shall have the meaning set forth in Section 4.2.

1.3 **"Billing Period"** means, unless otherwise agreed to, the time period between PacifiCorp's consecutive readings of its power purchase billing meter at the Facility in the normal course of PacifiCorp's business. Such periods typically range between twenty-seven (27) and thirty-four (34) days and may not coincide with calendar months.

1.4 **"Commercial Operation Date"** means the date that the Facility is deemed by PacifiCorp to be fully operational and reliable, which shall require, among other things, that all of the following events have occurred:

1.4.1 PacifiCorp has received a certificate addressed to PacifiCorp from a Licensed Professional Engineer stating (a) the Facility Capacity Rating of the Facility at the anticipated Commercial Operation Date; and (b) that the Facility is able to generate electric power reliably in amounts required by this Agreement and in accordance with all other terms and conditions of this Agreement;

1.4.2 The Facility has completed Start-Up Testing;

1.4.3 PacifiCorp has received a certificate addressed to PacifiCorp from a Licensed Professional Engineer stating that, (a), in accordance with the Generation Interconnection Agreement, all required interconnection facilities have been constructed, all required interconnection tests have been completed and the Facility is physically interconnected with PacifiCorp's electric system, or (b) if the Facility is interconnected with another electric utility that will wheel Net Output to PacifiCorp, all required interconnection facilities have been completed and tested and are in place to allow for such wheeling;

1.4.4 PacifiCorp has received a certificate addressed to PacifiCorp from an attorney in good standing in the State of Oregon stating that Seller has obtained all Required Facility Documents and if requested by PacifiCorp, in writing, has provided copies of any or all such requested Required Facility Documents. (Facilities over 200 kW only).

- 1.4.5 Seller has complied with the security requirements of Section 10.
- 1.4.6 PacifiCorp has received an executed copy of **Exhibit F**—Seller’s Interconnection Request.
- 1.5 “**Commission**” means the Oregon Public Utilities Commission.
- 1.6 “**Contract Price**” means the applicable price for capacity or energy, or both capacity and energy, stated in Sections 5.1 and 5.2.
- 1.7 “**Contract Year**” means a twelve (12) month period commencing at 00:00 hours Pacific Prevailing Time (“PPT”) on January 1 and ending on 24:00 hours PPT on December 31; *provided, however*, that the first Contract Year shall commence on the Commercial Operation Date and end on the next succeeding December 31, and the last Contract Year shall end on the Termination Date.
- 1.8 “**Credit Requirements**” means a long-term credit rating (corporate or long-term senior unsecured debt) of (1) “Baa3” or greater by Moody’s, or (2) “BBB-” or greater by S&P, or such other indicia of creditworthiness acceptable to PacifiCorp in its reasonable judgment.
- 1.9 “**Default Security**”, unless otherwise agreed to by the Parties in writing, means the amount of either a Letter of Credit or cash placed in an escrow account sufficient to replace twelve (12) average months of replacement power costs over the term of this Agreement, and shall be calculated by taking the average, over the term of this Agreement, of the positive difference between (a) the monthly forward power prices at **Mid-Columbia** (as determined by PacifiCorp in good faith using information from a commercially reasonable independent source), multiplied by 110%, minus (b) the average of the Fixed Avoided Cost Prices specified in Schedule 37, and multiplying such difference by (c) the Minimum Annual Delivery; provided, however, the amount of Default Security shall in no event be less than the amount equal to the payments PacifiCorp would make for three (3) average months based on Seller’s average monthly volume over the term of this Agreement and utilizing the average Fixed Avoided Cost Prices specified in Schedule 37. Such amount shall be fixed at the Effective Date of this Agreement.
- 1.10 “**Effective Date**” shall have the meaning set forth in Section 2.1.
- 1.11 “**Energy Delivery Schedule**” shall have the meaning set forth in Section 4.5.
- 1.12 “**Environmental Attributes**” shall have the meaning set forth in Section 5.5.
- 1.13 “**Excess Output**” shall mean any increment of Net Output delivered at a rate, on an hourly basis, exceeding the Facility Capacity Rating.
- 1.14 “**Facility**” shall have the meaning set forth in Recital A.
- 1.15 “**Facility Capacity Rating**” means the sum of the Nameplate Capacity Ratings for all generators comprising the Facility.

1.16 “**FERC**” means the Federal Energy Regulatory Commission, or its successor.

1.17 “**Generation Interconnection Agreement**” means the generation interconnection agreement to be entered into separately between Seller and PacifiCorp’s transmission or distribution department, as applicable, providing for the construction, operation, and maintenance of PacifiCorp’s interconnection facilities required to accommodate deliveries of Seller’s Net Output if the Facility is to be interconnected directly with PacifiCorp rather than another electric utility.

1.18 “**Letter of Credit**” means an irrevocable standby letter of credit, from an institution that has a long-term senior unsecured debt rating of “A” or greater from S&P or “A2” or greater from Moody’s, in a form reasonably acceptable to PacifiCorp, naming PacifiCorp as the party entitled to demand payment and present draw requests thereunder.

1.19 “**Licensed Professional Engineer**” means a person acceptable to PacifiCorp in its reasonable judgment who is licensed to practice engineering in the state of Oregon, who has no economic relationship, association, or nexus with the Seller, and who is not a representative of a consulting engineer, contractor, designer or other individual involved in the development of the Facility, or of a manufacturer or supplier of any equipment installed in the Facility. Such Licensed Professional Engineer shall be licensed in an appropriate engineering discipline for the required certification being made.

1.20 “**Material Adverse Change**” means the occurrence of any event of default under any material agreement to which Seller is a party and of any other development, financial or otherwise, which would have a material adverse effect on Seller, the Facility or Seller’s ability to develop, construct, operate, maintain or own the Facility as provided in this Agreement

1.21 “**Maximum Annual Delivery**” shall have the meaning set forth in Section 4.3.

1.22 “**Minimum Annual Delivery**” shall have the meaning set forth in Section 4.3.

1.23 “**Nameplate Capacity Rating**” means the full-load electrical quantities assigned by the designer to a generator and its prime mover or other piece of electrical equipment, such as transformers and circuit breakers, under standardized conditions, expressed in amperes, kilovoltamperes, kilowatts, volts, or other appropriate units. Usually indicated on a nameplate attached to the individual machine or device.

1.24 “**Net Energy**” means the energy component, in kWh, of Net Output.

1.25 “**Net Output**” means all energy and capacity produced by the Facility, less station use and less transformation and transmission losses and other adjustments (e.g., Seller’s load other than station use), if any. For purposes of calculating payment under this Agreement, Net Output of energy shall be the amount of energy flowing through the Point of Delivery.

1.26 “**Net Replacement Power Costs**” shall have the meaning set forth in Section 11.4.1.

1.27 “**Off-Peak Hours**” means all hours of the week that are not On-Peak Hours.

1.28 **"On-Peak Hours"** means the hours between 6 a.m. Pacific Prevailing Time ("PPT") and 10 p.m. PPT, Mondays through Saturdays, excluding all hours occurring on holidays as provided in Schedule 37.

1.29 **"Point of Delivery"** means the high side of the Seller's step-up transformer(s) located at the point of interconnection between the Facility and PacifiCorp's distribution/transmission system, as specified in the Generation Interconnection Agreement, or, if the Facility is not interconnected directly with PacifiCorp, the point at which another utility will deliver the Net Output to PacifiCorp as specified in **Exhibit B**.

1.30 **"Prime Rate"** means the publicly announced prime rate for commercial loans to large businesses with the highest credit rating in the United States in effect from time to time quoted by Citibank, N.A. If a Citibank, N.A. prime rate is not available, the applicable Prime Rate shall be the announced prime rate for commercial loans in effect from time to time quoted by a bank with \$10 billion or more in assets in New York City, New York, selected by the Party to whom interest based on the Prime Rate is being paid.

1.31 **"Prudent Electrical Practices"** means any of the practices, methods and acts engaged in or approved by a significant portion of the electrical utility industry or any of the practices, methods or acts, which, in the exercise of reasonable judgment in the light of the facts known at the time a decision is made, could have been expected to accomplish the desired result at the lowest reasonable cost consistent with reliability, safety and expedition. Prudent Electrical Practices is not intended to be limited to the optimum practice, method or act to the exclusion of all others, but rather to be a spectrum of possible practices, methods or acts.

1.32 **"QF"** means **"Qualifying Facility,"** as that term is defined in the FERC regulations (codified at 18 CFR Part 292) in effect on the Effective Date.

1.33 **"Replacement Price"** means the price at which PacifiCorp, acting in a commercially reasonable manner, purchases for delivery at the Point of Delivery a replacement for any Net Output that Seller is required to deliver under this Agreement plus (i) costs reasonably incurred by PacifiCorp in purchasing such replacement Net Output, and (ii) additional transmission charges, if any, reasonably incurred by PacifiCorp in causing replacement energy to be delivered to the Point of Delivery. If PacifiCorp elects not to make such a purchase, the Replacement Price shall be the market price at the Mid-Columbia trading hub for such energy not delivered, plus any additional cost or expense incurred as a result of Seller's failure to deliver, as determined by PacifiCorp in a commercially reasonable manner (but not including any penalties, ratcheted demand or similar charges).

1.34 **"Required Facility Documents"** means all licenses, permits, authorizations, and agreements, including a Generation Interconnection Agreement or equivalent, necessary for construction, operation, and maintenance of the Facility consistent with the terms of this Agreement, including without limitation those set forth in **Exhibit C**.

1.35 **"Schedule 37"** means the Schedule 37 of Pacific Power & Light Company's Commission-approved tariffs, providing pricing options for Qualifying Facilities of 10,000 kW

or less, which is in effect on the Effective Date of this Agreement. A copy of that Schedule 37 is attached as **Exhibit G**.

1.36 “**Scheduled Commercial Operation Date**” shall have the meaning set forth in Recital C.

1.37 “**Scheduled Initial Delivery Date**” shall have the meaning set forth in Recital B.

1.38 “**Start-Up Testing**” means the completion of required factory and start-up tests as set forth in **Exhibit E** hereto.

1.39 “**Termination Date**” shall have the meaning set forth in Section 2.4.

SECTION 2: TERM; COMMERCIAL OPERATION DATE

2.1 This Agreement shall become effective after execution by both Parties (“**Effective Date**”).

2.2 **Time is of the essence for this Agreement**, and Seller's ability to meet certain requirements prior to the Commercial Operation Date and to deliver Net Output by the Scheduled Commercial Operation Date is critically important. Therefore,

2.2.1 By October 31, 2015 Seller shall provide PacifiCorp with a copy of an executed Generation Interconnection Agreement, or wheeling agreement, as applicable, which shall be consistent with all material terms and requirements of this Agreement.

2.2.2 Upon completion of construction, Seller, in accordance with Section 6.1, shall provide PacifiCorp with an As-built Supplement acceptable to PacifiCorp;

2.2.3 By the date thirty (30) days after the Effective Date, Seller shall provide Default Security required under Sections 10.1 or 10.2, as applicable.

2.3 Seller shall cause the Facility to achieve Commercial Operation on or before the Scheduled Commercial Operation Date. If Commercial Operation occurs after the Scheduled Commercial Operation Date, Seller shall be in default, and liable for delay damages specified in Section 11.

2.4 Except as otherwise provided herein, this Agreement shall terminate on November 30, 2036 (“**Termination Date**”).

SECTION 3: REPRESENTATIONS AND WARRANTIES

3.1 PacifiCorp represents, covenants, and warrants to Seller that:

- 3.1.1 PacifiCorp is duly organized and validly existing under the laws of the State of Oregon.
 - 3.1.2 PacifiCorp has the requisite corporate power and authority to enter into this Agreement and to perform according to the terms of this Agreement.
 - 3.1.3 PacifiCorp has taken all corporate actions required to be taken by it to authorize the execution, delivery and performance of this Agreement and the consummation of the transactions contemplated hereby.
 - 3.1.4 The execution and delivery of this Agreement does not contravene any provision of, or constitute a default under, any indenture, mortgage, or other material agreement binding on PacifiCorp or any valid order of any court, or any regulatory agency or other body having authority to which PacifiCorp is subject.
 - 3.1.5 This Agreement is a valid and legally binding obligation of PacifiCorp, enforceable against PacifiCorp in accordance with its terms (except as the enforceability of this Agreement may be limited by bankruptcy, insolvency, bank moratorium or similar laws affecting creditors' rights generally and laws restricting the availability of equitable remedies and except as the enforceability of this Agreement may be subject to general principles of equity, whether or not such enforceability is considered in a proceeding at equity or in law).
- 3.2 Seller represents, covenants, and warrants to PacifiCorp that:
- 3.2.1 Seller is a limited liability company duly organized and validly existing under the laws of Oregon.
 - 3.2.2 Seller has the requisite power and authority to enter into this Agreement and to perform according to the terms hereof, including all required regulatory authority to make wholesale sales from the Facility.
 - 3.2.3 Seller has taken all actions required to authorize the execution, delivery and performance of this Agreement and the consummation of the transactions contemplated hereby.
 - 3.2.4 The execution and delivery of this Agreement does not contravene any provision of, or constitute a default under, any indenture, mortgage, or other material agreement binding on Seller or any valid order of any court, or any regulatory agency or other body having authority to which Seller is subject.
 - 3.2.5 This Agreement is a valid and legally binding obligation of Seller, enforceable against Seller in accordance with its terms (except as the enforceability of this Agreement may be limited by bankruptcy, insolvency, bank moratorium or similar laws affecting creditors' rights

generally and laws restricting the availability of equitable remedies and except as the enforceability of this Agreement may be subject to general principles of equity, whether or not such enforceability is considered in a proceeding at equity or in law).

3.2.6 The Facility is and shall for the term of this Agreement continue to be a QF, and Seller will operate the Facility in a manner consistent with its FERC QF certification. Seller has provided to PacifiCorp the appropriate QF certification (which may include a FERC self-certification) prior to PacifiCorp's execution of this Agreement. At any time during the term of this Agreement, PacifiCorp may require Seller to provide PacifiCorp with evidence satisfactory to PacifiCorp in its reasonable discretion that the Facility continues to qualify as a QF under all applicable requirements and, if PacifiCorp is not satisfied that the Facility qualifies for such status, a written legal opinion from an attorney who is (a) in good standing in the state of Oregon, and (b) who has no economic relationship, association or nexus with the Seller or the Facility, stating that the Facility is a QF and providing sufficient proof (including copies of all documents and data as PacifiCorp may request) demonstrating that Seller has maintained and will continue to maintain the Facility as a QF.

3.2.7 Compliance with Partial Stipulation in Commission Proceeding No. UM-1129. Seller will not make any changes in its ownership, control, or management during the term of this Agreement that would cause it to not be in compliance with the definition of a Small Cogeneration Facility or Small Power Production Facility provided in PacifiCorp's Schedule 37 tariff approved by the Commission at the time this Agreement is executed. Seller will provide, upon request by PacifiCorp not more frequently than every 36 months, such documentation and information as reasonably may be required to establish Seller's continued compliance with such Definition. PacifiCorp agrees to take reasonable steps to maintain the confidentiality of any portion of the above-described documentation and information that the Seller identifies as confidential except PacifiCorp will provide all such confidential information the Public Utility Commission of Oregon upon the Commission's request.

3.2.8 Additional Seller Creditworthiness Warranties. Seller need not post security under Section 10 for PacifiCorp's benefit in the event of Seller default, provided that Seller warrants all of the following:

- (a) Neither the Seller nor any of its principal equity owners is or has within the past two (2) years been the debtor in any bankruptcy proceeding, is unable to pay its bills in the ordinary course of its business, or is the subject of any legal or regulatory action, the result of which could reasonably be expected to impair Seller's ability to own and operate the Facility in accordance with the terms of this Agreement.

- (b) Seller has not at any time defaulted in any of its payment obligations for electricity purchased from PacifiCorp.
- (c) Seller is not in default under any of its other agreements and is current on all of its financial obligations, including construction related financial obligations.
- (d) Seller owns, and will continue to own for the term of this Agreement, all right, title and interest in and to the Facility, free and clear of all liens and encumbrances other than liens and encumbrances related to third-party financing of the Facility.
- (e) **[Applicable only to Seller's with a Facility having a Facility Capacity Rating greater than 3,000 kW]** Seller meets the Credit Requirements.

Seller hereby declares (Seller initial one only):

- _____ Seller affirms and adopts all warranties of this Section 3.2.8, and therefore is not required to post security under Section 10; or
- X Seller does not affirm and adopt all warranties of this Section 3.2.8, and therefore Seller elects to post the security specified in Section 10.

3.3 Notice. If at any time during this Agreement, any Party obtains actual knowledge of any event or information which would have caused any of the representations and warranties in this Section 3 to have been materially untrue or misleading when made, such Party shall provide the other Party with written notice of the event or information, the representations and warranties affected, and the action, if any, which such Party intends to take to make the representations and warranties true and correct. The notice required pursuant to this Section shall be given as soon as practicable after the occurrence of each such event.

SECTION 4: DELIVERY OF POWER

4.1 Commencing on the Commercial Operation Date, unless otherwise provided herein, Seller will sell and PacifiCorp will purchase all Net Output from the Facility delivered to the Point of Delivery.

4.2 Average Annual Generation. Seller estimates that the Facility will generate, on average, 17,518,000 kWh per Contract Year (“**Average Annual Generation**”). Seller may, upon at least six months prior written notice, modify the Average Annual Generation every other Contract Year.

4.3 Minimum and Maximum Delivery. Seller shall make available from the Facility a minimum of 7,007,000 kWh of Net Output during each Contract Year, provided that such minimum for the first Contract Year shall be reduced pro rata to reflect the Commercial Operation Date, and further provided that such minimum Net Output shall be reduced on a pro-rata basis for any periods during a Contract Year that the Facility was prevented from generating electricity for reasons of Force Majeure (“**Minimum Annual Delivery**”). Seller estimates, for informational purposes, that it will make available from the Facility a maximum of 21,900,000 kWh of Net Output during each Contract Year (“**Maximum Annual Delivery**”). Seller’s basis for determining the Minimum and Maximum Annual Delivery amounts is set forth in **Exhibit D**.

4.4 Deliveries in Deficit of Delivery Obligation. Seller’s failure to deliver the Minimum Annual Delivery in any Contract Year (prorated if necessary) shall be a default, and Seller shall be liable for damages in accordance with Section 11.

4.5 Energy Delivery Schedule. Seller has provided a monthly schedule of Net Energy expected to be delivered by the Facility (“**Energy Delivery Schedule**”), incorporated into **Exhibit D**.

SECTION 5: PURCHASE PRICES

5.1 Seller shall have the option to select one of four pricing options: Fixed Avoided Cost Prices (“Fixed Price”), Firm Market Indexed Avoided Cost Prices (“Firm Electric Market”), Gas Market Indexed Avoided Cost Prices (“Gas Market”), or Banded Gas Market Indexed Avoided Cost Prices (“Banded Gas Market”), as published in Schedule 37. Once an option is selected the option will remain in effect for the duration of the Facility’s contract. Seller has selected the following (Seller to initial one):

- Fixed Price
- Firm Electric Market
- Gas Market
- Banded Gas Market

A copy of Schedule 37, and a table summarizing the purchase prices under the pricing option selected by Seller, is attached as **Exhibit G**.

5.2 (Fixed Price Sellers Only). In the event Seller elects the Fixed Price payment method, PacifiCorp shall pay Seller the applicable On-Peak and Off-Peak rates specified in **Schedule 37** during the first fifteen (15) years after the Scheduled Initial Delivery Date. Thereafter, PacifiCorp shall pay Seller market-based rates, using the following pricing option (Seller to initial one):

- Firm Electric Market
- Gas Market
- Banded Gas Market

5.3 If the Seller elects a gas market indexed price option, the index shall be the Opal Gas Market Index as provided in Schedule 37. In the event that Platt ceases to publish the Opal Gas Market Index, the Company shall replace the index with a similar gas index.

5.4 For all Excess Output and for all Net Output delivered prior to the Commercial Operation Date, PacifiCorp shall pay Seller a blended market index price for day-ahead non-firm energy at Mid-Columbia, California Oregon Border (COB), Four Corners and Palo Verde market indices as reported by Dow Jones, for the On-Peak and Off-Peak periods. PacifiCorp shall document its calculation of the blended rate, upon request, to Seller. Such payment will be accomplished by adjustments pursuant to Section 9.2.

5.5 Environmental Attributes. PacifiCorp waives any claim to Seller's ownership of Environmental Attributes under this Agreement. Environmental Attributes include, but are not limited to, Green Tags, Green Certificates, Renewable Energy Credits (RECs) and Tradable Renewable Certificates (TRCs) (as those terms are commonly used in the regional electric utility industry) directly associated with the production of energy from the Seller's Facility.

SECTION 6: OPERATION AND CONTROL

6.1 As-Built Supplement. Upon completion of initial (and any subsequent) construction of the Facility, Seller shall provide PacifiCorp an As-built Supplement to specify the actual Facility as built. The As-built Supplement must be reviewed and approved by PacifiCorp, which approval shall not unreasonably be withheld, conditioned or delayed.

6.2 Incremental Utility Upgrades. At start-up (and at any other time upon at least six month's prior written notice), Seller may increase Net Output, if such increase is due to normal variances in estimated versus actual performance, changed Facility operations, or improvements in Facility efficiency. Seller may not increase Net Output under this Agreement by installing additional generating units. In the case of substantial upgrades, PacifiCorp may require Seller to comply with Section 3.2.8(e) (in the event that the Facility upgrade causes the Facility Capacity Rating to exceed 3,000 kW) and increase its Minimum Annual Delivery obligation in Section 4.3 (if appropriate). PacifiCorp may also update Seller's security obligation (if applicable). So long as the Facility Capacity Rating after the upgrade is 10,000 kW or less, Seller will continue to receive the Contract Price for the Net Output, as set forth in Sections 5.1 and 5.2 of this Agreement. If Seller increases the Facility Capacity Rating above 10,000 kW, then (on a going forward basis) PacifiCorp shall pay Seller the Contract Price for the fraction of total Net Output equal to 10,000 kW divided by the Facility Capacity Rating of the upgraded Facility. For the remaining fraction of Net Output, PacifiCorp and Seller shall agree to a new negotiated rate. Seller shall be responsible for ensuring that any planned increase in the Facility Capacity Rating or the maximum instantaneous capacity of the Facility complies with Seller's Generation Interconnection Agreement and any other agreements with PacifiCorp.

6.3 Seller shall operate and maintain the Facility in a safe manner in accordance with the Generation Interconnection Agreement (if applicable), Prudent Electrical Practices and in accordance with the requirements of all applicable federal, state and local laws and the National Electric Safety Code as such laws and code may be amended from time to time. PacifiCorp shall

have no obligation to purchase Net Output from the Facility to the extent the interconnection between the Facility and PacifiCorp's electric system is disconnected, suspended or interrupted, in whole or in part, pursuant to the Generation Interconnection Agreement, or to the extent generation curtailment is required as a result of Seller's non-compliance with the Generation Interconnection Agreement. PacifiCorp shall have the right to inspect the Facility to confirm that Seller is operating the Facility in accordance with the provisions of this Section 6.3 upon reasonable notice to Seller. Seller is solely responsible for the operation and maintenance of the Facility. PacifiCorp shall not, by reason of its decision to inspect or not to inspect the Facility, or by any action or inaction taken with respect to any such inspection, assume or be held responsible for any liability or occurrence arising from the operation and maintenance by Seller of the Facility.

6.4 Scheduled Outages. Seller may cease operation of the entire Facility or individual units, if applicable, for maintenance or other purposes. Seller shall exercise its best efforts to notify PacifiCorp of planned outages at least ninety (90) days prior, and shall reasonably accommodate PacifiCorp's request, if any, to reschedule such planned outage in order to accommodate PacifiCorp's need for Facility operation.

6.5 Unplanned Outages. In the event of an unscheduled outage or curtailment exceeding twenty-five (25) percent of the Facility Capacity Rating (other than curtailments due to lack of motive force), Seller immediately shall notify PacifiCorp of the necessity of such unscheduled outage or curtailment, the time when such has occurred or will occur and the anticipated duration. Seller shall take all reasonable measures and exercise its best efforts to avoid unscheduled outage or curtailment, to limit the duration of such, and to perform unscheduled maintenance during Off-Peak hours.

SECTION 7: FUEL/MOTIVE FORCE

Prior to the Effective Date of this Agreement, Seller provided to PacifiCorp a fuel or motive force plan acceptable to PacifiCorp in its reasonable discretion and attached hereto as **Exhibit D-1**, together with a certification from a Licensed Professional Engineer to PacifiCorp attached hereto as **Exhibit D-2**, certifying that the implementation of the fuel or motive force plan can reasonably be expected to provide fuel or motive force to the Facility for the duration of this Agreement adequate to generate power and energy in quantities necessary to deliver the Minimum Annual Delivery set forth by Seller in Section 4.

SECTION 8: METERING

8.1 PacifiCorp shall design, furnish, install, own, inspect, test, maintain and replace all metering equipment required pursuant to the Generation Interconnection Agreement, if applicable.

8.2 Metering shall be performed at the location and in a manner consistent with this Agreement and as specified in the Generation Interconnection Agreement, or, if the Net Output is to be wheeled to PacifiCorp by another utility, metering will be performed in accordance with the terms of PacifiCorp's interconnection agreement with such other utility. All quantities of

energy purchased hereunder shall be adjusted to account for electrical losses, if any between the point of metering and the Point of Delivery, so that the purchased amount reflects the net amount of energy flowing into PacifiCorp's system at the Point of Delivery.

8.3 PacifiCorp shall periodically inspect, test, repair and replace the metering equipment as provided in the Generation Interconnection Agreement, if applicable. If the Net Output is to be wheeled to PacifiCorp by another utility, meter inspection, testing, repair and replacement will be performed in accordance with the terms of PacifiCorp's interconnection agreement with such utility. If any of the inspections or tests discloses an error exceeding two percent (2%), either fast or slow, proper correction, based upon the inaccuracy found, shall be made of previous readings for the actual period during which the metering equipment rendered inaccurate measurements if that period can be ascertained. If the actual period cannot be ascertained, the proper correction shall be made to the measurements taken during the time the metering equipment was in service since last tested, but not exceeding three (3) Billing Periods, in the amount the metering equipment shall have been shown to be in error by such test. Any correction in billings or payments resulting from a correction in the meter records shall be made in the next monthly billing or payment rendered following the repair of the meter.

SECTION 9: BILLINGS, COMPUTATIONS, AND PAYMENTS

9.1 On or before the thirtieth (30th) day following the end of each Billing Period, PacifiCorp shall send to Seller payment for Seller's deliveries of Net Output to PacifiCorp, together with computations supporting such payment. PacifiCorp may offset any such payment to reflect amounts owing from Seller to PacifiCorp pursuant to this Agreement, the Generation Interconnection Agreement, or any other agreement between the Parties.

9.2 Corrections. PacifiCorp shall have up to eighteen months to adjust any payment made pursuant to Section 9.1. In the event PacifiCorp determines it has overpaid Seller (for Excess Output or otherwise), PacifiCorp may adjust Seller's future payment accordingly in order to recapture any overpayment in a reasonable time.

9.3 Any amounts owing after the due date thereof shall bear interest at the Prime Rate plus two percent (2%) from the date due until paid; *provided, however*, that the interest rate shall at no time exceed the maximum rate allowed by applicable law.

SECTION 10: SECURITY

Unless Seller has adopted the creditworthiness warranties contained in Section 3.2.8, Seller must provide security (if requested by PacifiCorp) in the form of a cash escrow, letter of credit, senior lien, or step-in rights. Seller hereby elects to provide, in accordance with the applicable terms of this Section 10, the following security (Seller to initial one selection only):

_____ Cash Escrow

_____ Letter of Credit

Senior Lien
 Step-in Rights

Seller has adopted the Creditworthiness Warranties of Section 3.2.8.

In the event Seller's obligation to post default security (under Section 10 or Section 11.1.4) arises solely from Seller's delinquent performance of construction-related financial obligations, upon Seller's request, PacifiCorp will excuse Seller from such obligation in the event Seller has negotiated financial arrangements with its construction lenders that mitigate Seller's financial risks to PacifiCorp's reasonable satisfaction.

[SKIP THIS SECTION 10.1 UNLESS SELLER SELECTED CASH ESCROW ALTERNATIVE]

10.1 Cash Escrow Security. Seller shall deposit in an escrow account established by PacifiCorp in a banking institution acceptable to both Parties, the Default Security. Such sum shall earn interest at the rate applicable to money market deposits at such banking institution from time to time. To the extent PacifiCorp receives payment from the Default Security, Seller shall, within fifteen (15) days, restore the Default Security as if no such deduction had occurred.

[SKIP THIS SECTION 10.2 UNLESS SELLER SELECTED LETTER OF CREDIT ALTERNATIVE]

10.2 Letter of Credit Security. Seller shall post and maintain in an amount equal to the Default Security: (a) a guaranty from a party that satisfies the Credit Requirements, in a form acceptable to PacifiCorp in its discretion, or (b) a Letter of Credit in favor of PacifiCorp. To the extent PacifiCorp receives payment from the Default Security, Seller shall, within fifteen (15) days, restore the Default Security as if no such deduction had occurred.

[SKIP THIS SECTION 10.3 UNLESS SELLER SELECTED SENIOR LIEN ALTERNATIVE]

10.3 Senior Lien. Before the Scheduled Commercial Operation Date, Seller shall grant PacifiCorp a senior, unsubordinated lien on the Facility and its assets as security for performance of this Agreement by executing, acknowledging and delivering a security agreement and a deed of trust or a mortgage, in a recordable form (each in a form satisfactory to PacifiCorp in the reasonable exercise of its discretion). Pending delivery of the senior lien to PacifiCorp, Seller shall not cause or permit the Facility or its assets to be burdened by liens or other encumbrances that would be superior to PacifiCorp's, other than workers', mechanics', suppliers' or similar liens, or tax liens, in each case arising in the ordinary course of business that are either not yet due and payable or that have been released by means of a performance bond posted within eight (8) calendar days of the commencement of any proceeding to foreclose the lien.

[SKIP THIS SECTION 10.4 UNLESS SELLER SELECTED STEP-IN RIGHTS ALTERNATIVE]

10.4 Step-in Rights (Operation by PacifiCorp Following Event of Default of Seller).

- 10.4.1 Prior to any termination of this Agreement due to an Event of Default of Seller, as identified in Section 11, PacifiCorp shall have the right, but not the obligation, to possess, assume control of, and operate the Facility as agent for Seller (in accordance with Seller's rights, obligations, and interest under this Agreement) during the period provided for herein. Seller shall not grant any person, other than the lending institution providing financing to the Seller for construction of the Facility ("Facility Lender"), a right to possess, assume control of, and operate the Facility that is equal to or superior to PacifiCorp's right under this Section 10.4.
- 10.4.2 PacifiCorp shall give Seller ten (10) calendar days notice in advance of the contemplated exercise of PacifiCorp's rights under this Section 10.4. Upon such notice, Seller shall collect and have available at a convenient, central location at the Facility all documents, contracts, books, manuals, reports, and records required to construct, operate, and maintain the Facility in accordance with Prudent Electrical Practices. Upon such notice, PacifiCorp, its employees, contractors, or designated third parties shall have the unrestricted right to enter the Facility for the purpose of constructing and/or operating the Facility. Seller hereby irrevocably appoints PacifiCorp as Seller's attorney-in-fact for the exclusive purpose of executing such documents and taking such other actions as PacifiCorp may reasonably deem necessary or appropriate to exercise PacifiCorp's step-in rights under this Section 10.4.
- 10.4.3 During any period that PacifiCorp is in possession of and constructing and/or operating the Facility, no proceeds or other monies attributed to operation of the Facility shall be remitted to or otherwise provided to the account of Seller until all Events of Default of Seller have been cured.
- 10.4.4 During any period that PacifiCorp is in possession of and operating the Facility, Seller shall retain legal title to and ownership of the Facility and PacifiCorp shall assume possession, operation, and control solely as agent for Seller.
- (a) In the event PacifiCorp is in possession and control of the Facility for an interim period, Seller shall resume operation and PacifiCorp shall relinquish its right to operate when Seller demonstrates to PacifiCorp's reasonable satisfaction that it will remove those grounds that originally gave rise to PacifiCorp's right to operate the Facility, as provided above, in that Seller (i) will resume operation of the Facility in accordance with the provisions of this Agreement, and (ii) has cured any Events of Default of Seller which allowed PacifiCorp to exercise its rights under this Section 10.4.
- (b) In the event that PacifiCorp is in possession and control of the Facility for an interim period, the Facility Lender, or any nominee

or transferee thereof, may foreclose and take possession of and operate the Facility and PacifiCorp shall relinquish its right to operate when the Facility Lender or any nominee or transferee thereof, requests such relinquishment.

10.4.5 PacifiCorp's exercise of its rights hereunder to possess and operate the Facility shall not be deemed an assumption by PacifiCorp of any liability attributable to Seller. If at any time after exercising its rights to take possession of and operate the Facility PacifiCorp elects to return such possession and operation to Seller, PacifiCorp shall provide Seller with at least fifteen (15) calendar days advance notice of the date PacifiCorp intends to return such possession and operation, and upon receipt of such notice Seller shall take all measures necessary to resume possession and operation of the Facility on such date.

SECTION 11: DEFAULTS AND REMEDIES

11.1 Events of Default. The following events shall constitute defaults under this Agreement:

11.1.1 Breach of Material Term. Failure of a Party to perform any material obligation imposed upon that Party by this Agreement (including but not limited to failure by Seller to meet any deadline set forth in Section 2) or breach by a Party of a representation or warranty set forth in this Agreement.

11.1.2 Default on Other Agreements. Seller's failure to cure any default under any commercial or financing agreements or instrument (including the Generation Interconnection Agreement) within the time allowed for a cure under such agreement or instrument.

11.1.3 Insolvency. A Party (a) makes an assignment for the benefit of its creditors; (b) files a petition or otherwise commences, authorizes or acquiesces in the commencement of a proceeding or cause of action under any bankruptcy or similar law for the protection of creditors, or has such a petition filed against it and such petition is not withdrawn or dismissed within sixty (60) days after such filing; (c) becomes insolvent; or (d) is unable to pay its debts when due.

11.1.4 Material Adverse Change. A Material Adverse Change has occurred with respect to Seller and Seller fails to provide such performance assurances as are reasonably requested by PacifiCorp, including without limitation the posting of additional Default Security, within thirty (30) days from the date of such request;

- 11.1.5 Delayed Commercial Operations. Seller's failure to achieve the Commercial Operation Date by the Scheduled Commercial Operation Date.
- 11.1.6 Underdelivery. If Seller's Facility has a Facility Capacity Rating of 100 kW or less, Seller's failure to satisfy the minimum delivery obligation of Section 4.3 for two (2) consecutive years; else Seller's failure to satisfy the minimum delivery obligation of Section 4.3 for one year.
- 11.2 Notice; Opportunity to Cure.
- 11.2.1 Notice. In the event of any default hereunder, the non-defaulting Party must notify the defaulting Party in writing of the circumstances indicating the default and outlining the requirements to cure the default.
- 11.2.2 Opportunity to Cure. A Party defaulting under Section 11.1.1 or 11.1.5 shall have thirty (30) days to cure after receipt of proper notice from the non-defaulting Party. This thirty (30) day period shall be extended by an additional ninety (90) days if (a) the failure cannot reasonably be cured within the thirty (30) day period despite diligent efforts, (b) the default is capable of being cured within the additional ninety (90) day period, and (c) the defaulting Party commences the cure within the original thirty (30) day period and is at all times thereafter diligently and continuously proceeding to cure the failure.
- 11.2.3 Seller Default Under Other Agreements. Seller shall cause any notices of default under any of its commercial or financing agreements or instruments to be sent by the other party to such agreements or instruments, or immediately forwarded, to PacifiCorp as a notice in accordance with Section 23.
- 11.2.4 Seller Delinquent on Construction-related Financial Obligations. Seller promptly shall notify PacifiCorp (or cause PacifiCorp to be notified) anytime it becomes delinquent under any construction related financing agreement or instrument related to the Facility. Such delinquency may constitute a Material Adverse Change, subject to Section 11.1.4.
- 11.3 Termination.
- 11.3.1 Notice of Termination. If a default described herein has not been cured within the prescribed time, above, the non-defaulting Party may terminate this Agreement at its sole discretion by delivering written notice to the other Party and may pursue any and all legal or equitable remedies provided by law or pursuant to this Agreement; *provided, however* that PacifiCorp shall not terminate: (a) for a default under Section 11.1.5 unless PacifiCorp is in a resource deficient state during the period Commercial Operation is delayed; or (b) for a default under Section 11.1.6, unless such default is material. The rights provided in Section 10

and this Section 11 are cumulative such that the exercise of one or more rights shall not constitute a waiver of any other rights. Further, the Parties may by mutual written agreement amend this Agreement in lieu of a Party's exercise of its right to terminate.

11.3.2 In the event this Agreement is terminated because of Seller's default and Seller wishes to again sell Net Output to PacifiCorp following such termination, PacifiCorp in its sole discretion may require that Seller shall do so subject to the terms of this Agreement, including but not limited to the Contract Price, until the Termination Date (as set forth in Section 2.4). At such time Seller and PacifiCorp agree to execute a written document ratifying the terms of this Agreement.

11.3.3 Damages. If this Agreement is terminated as a result of Seller's default, Seller shall pay PacifiCorp the positive difference, if any, obtained by subtracting the Contract Price from the sum of the Replacement Price for the Minimum Annual Delivery that Seller was otherwise obligated to provide for a period of twenty-four (24) months from the date of termination plus any cost incurred for transmission purchased to deliver the replacement power to the Point of Delivery, and the estimated administrative cost to the utility to acquire replacement power. Amounts owed by Seller pursuant to this paragraph shall be due within five (5) business days after any invoice from PacifiCorp for the same.

11.3.4 If this Agreement is terminated because of Seller's default, PacifiCorp may foreclose upon any security provided pursuant to Section 10 to satisfy any amounts that Seller owes PacifiCorp arising from such default.

11.4 Damages.

11.4.1 Failure to Deliver Net Output. In the event of Seller default under Subsection 11.1.5 or Subsection 11.1.6, then Seller shall pay PacifiCorp the positive difference, if any, obtained by subtracting the Contract Price from the Replacement Price for any energy and capacity that Seller was otherwise obligated (under Section 4.3) to provide during the period of default ("**Net Replacement Power Costs**"); *provided, however*, that the positive difference obtained by subtracting the Contract Price from the Replacement Price shall not exceed the Contract Price, and the period of default under this Section 11.4.1 shall not exceed one Contract Year.

11.4.2 Recoupment of Damages.

(a) Default Security Available. If Seller has posted Default Security, PacifiCorp may draw upon that security to satisfy any damages, above.

(b) Default Security Unavailable. If Seller has not posted Default Security, or if PacifiCorp has exhausted the Default Security,

PacifiCorp may collect any remaining amount owing by partially withholding future payments to Seller over a reasonable period of time, which period shall not be less than the period over which the default occurred. PacifiCorp and Seller shall work together in good faith to establish the period, and monthly amounts, of such withholding so as to avoid Seller's default on its commercial or financing agreements necessary for its continued operation of the Facility.

SECTION 12: INDEMNIFICATION AND LIABILITY

12.1 Indemnities.

12.1.1 Indemnity by Seller. Seller shall release, indemnify and hold harmless PacifiCorp, its directors, officers, agents, and representatives against and from any and all loss, fines, penalties, claims, actions or suits, including costs and attorney's fees, both at trial and on appeal, resulting from, or arising out of or in any way connected with (a) the energy delivered by Seller under this Agreement to and at the Point of Delivery, (b) any facilities on Seller's side of the Point of Delivery, (c) Seller's operation and/or maintenance of the Facility, or (d) arising from this Agreement, including without limitation any loss, claim, action or suit, for or on account of injury, bodily or otherwise, to, or death of, persons, or for damage to, or destruction or economic loss of property belonging to PacifiCorp, Seller or others, excepting only such loss, claim, action or suit as may be caused solely by the fault or gross negligence of PacifiCorp, its directors, officers, employees, agents or representatives.

12.1.2 Indemnity by PacifiCorp. PacifiCorp shall release, indemnify and hold harmless Seller, its directors, officers, agents, Lenders and representatives against and from any and all loss, fines, penalties, claims, actions or suits, including costs and attorney's fees, both at trial and on appeal, resulting from, or arising out of or in any way connected with the energy delivered by Seller under this Agreement after the Point of Delivery, including without limitation any loss, claim, action or suit, for or on account of injury, bodily or otherwise, to, or death of, persons, or for damage to, or destruction or economic loss of property, excepting only such loss, claim, action or suit as may be caused solely by the fault or gross negligence of Seller, its directors, officers, employees, agents, Lenders or representatives.

12.2 No Dedication. Nothing in this Agreement shall be construed to create any duty to, any standard of care with reference to, or any liability to any person not a Party to this Agreement. No undertaking by one Party to the other under any provision of this Agreement shall constitute the dedication of that Party's system or any portion thereof to the other Party or

to the public, nor affect the status of PacifiCorp as an independent public utility corporation or Seller as an independent individual or entity.

12.3 No Consequential Damages. EXCEPT TO THE EXTENT SUCH DAMAGES ARE INCLUDED IN THE LIQUIDATED DAMAGES, DELAY DAMAGES, COST TO COVER DAMAGES OR OTHER SPECIFIED MEASURE OF DAMAGES EXPRESSLY PROVIDED FOR IN THIS AGREEMENT, NEITHER PARTY SHALL BE LIABLE TO THE OTHER PARTY FOR SPECIAL, PUNITIVE, INDIRECT, EXEMPLARY OR CONSEQUENTIAL DAMAGES, WHETHER SUCH DAMAGES ARE ALLOWED OR PROVIDED BY CONTRACT, TORT (INCLUDING NEGLIGENCE), STRICT LIABILITY, STATUTE OR OTHERWISE.

SECTION 13: INSURANCE (FACILITIES OVER 200KW ONLY)

13.1 Certificates. Prior to connection of the Facility to PacifiCorp's electric system, or another utility's electric system if delivery to PacifiCorp is to be accomplished by wheeling, Seller shall secure and continuously carry insurance in compliance with the requirements of this Section. Seller shall provide PacifiCorp insurance certificate(s) (of "ACORD Form" or the equivalent) certifying Seller's compliance with the insurance requirements hereunder. Commercial General Liability coverage written on a "claims-made" basis, if any, shall be specifically identified on the certificate. If requested by PacifiCorp, a copy of each insurance policy, certified as a true copy by an authorized representative of the issuing insurance company, shall be furnished to PacifiCorp.

13.2 Required Policies and Coverages. Without limiting any liabilities or any other obligations of Seller under this Agreement, Seller shall secure and continuously carry with an insurance company or companies rated not lower than "B+" by the A.M. Best Company the insurance coverage specified below:

13.2.1 Commercial General Liability insurance, to include contractual liability, with a minimum single limit of \$1,000,000 to protect against and from all loss by reason of injury to persons or damage to property based upon and arising out of the activity under this Agreement.

13.2.2 All Risk Property insurance providing coverage in an amount at least equal to the full replacement value of the Facility against "all risks" of physical loss or damage, including coverage for earth movement, flood, and boiler and machinery. The Risk policy may contain separate sub-limits and deductibles subject to insurance company underwriting guidelines. The Risk Policy will be maintained in accordance with terms available in the insurance market for similar facilities.

13.3 The Commercial General Liability policy required herein shall include i) provisions or endorsements naming PacifiCorp, its Board of Directors, Officers and employees as additional insureds, and ii) cross liability coverage so that the insurance applies separately to each insured against whom claim is made or suit is brought, even in instances where one insured claims against or sues another insured.

13.4 All liability policies required by this Agreement shall include provisions that such insurance is primary insurance with respect to the interests of PacifiCorp and that any other insurance maintained by PacifiCorp is excess and not contributory insurance with the insurance required hereunder, and provisions that such policies shall not be canceled or their limits of liability reduced without 1) ten (10) days prior written notice to PacifiCorp if canceled for nonpayment of premium, or 2) thirty (30) days prior written notice to PacifiCorp if canceled for any other reason.

13.5 Insurance coverage provided on a "claims-made" basis shall be maintained by Seller for a minimum period of five (5) years after the completion of this Agreement and for such other length of time necessary to cover liabilities arising out of the activities under this Agreement.

SECTION 14: FORCE MAJEURE

14.1 As used in this Agreement, “**Force Majeure**” or “**an event of Force Majeure**” means any cause beyond the reasonable control of the Seller or of PacifiCorp which, despite the exercise of due diligence, such Party is unable to prevent or overcome. By way of example, Force Majeure may include but is not limited to acts of God, fire, flood, storms, wars, hostilities, civil strife, strikes, and other labor disturbances, earthquakes, fires, lightning, epidemics, sabotage, restraint by court order or other delay or failure in the performance as a result of any action or inaction on behalf of a public authority which by the exercise of reasonable foresight such Party could not reasonably have been expected to avoid and by the exercise of due diligence, it shall be unable to overcome, subject, in each case, to the requirements of the first sentence of this paragraph. Force Majeure, however, specifically excludes the cost or availability of fuel or motive force resources to operate the Facility or changes in market conditions that affect the price of energy or transmission. If either Party is rendered wholly or in part unable to perform its obligation under this Agreement because of an event of Force Majeure, that Party shall be excused from whatever performance is affected by the event of Force Majeure to the extent and for the duration of the event of Force Majeure, after which such Party shall recommence performance of such obligation, provided that:

- 14.1.1 the non-performing Party, shall, within two (2) weeks after the occurrence of the Force Majeure, give the other Party written notice describing the particulars of the occurrence; and
- 14.1.2 the suspension of performance shall be of no greater scope and of no longer duration than is required by the event of Force Majeure; and
- 14.1.3 the non-performing Party uses its best efforts to remedy its inability to perform.

14.2 No obligations of either Party which arose before the Force Majeure causing the suspension of performance shall be excused as a result of the event of Force Majeure.

14.3 Neither Party shall be required to settle any strike, walkout, lockout or other labor dispute on terms which, in the sole judgment of the Party involved in the dispute, are contrary to the Party's best interests.

14.4 PacifiCorp may terminate the Agreement if Seller fails to remedy Seller's inability to perform, due to an event of Force Majeure, within six months after the occurrence of the event.

SECTION 15: SEVERAL OBLIGATIONS

Nothing contained in this Agreement shall ever be construed to create an association, trust, partnership or joint venture or to impose a trust or partnership duty, obligation or liability between the Parties. If Seller includes two or more parties, each such party shall be jointly and severally liable for Seller's obligations under this Agreement.

SECTION 16: CHOICE OF LAW

This Agreement shall be interpreted and enforced in accordance with the laws of the State of Oregon, excluding any choice of law rules which may direct the application of the laws of another jurisdiction.

SECTION 17: PARTIAL INVALIDITY

It is not the intention of the Parties to violate any laws governing the subject matter of this Agreement. If any of the terms of the Agreement are finally held or determined to be invalid, illegal or void as being contrary to any applicable law or public policy, all other terms of the Agreement shall remain in effect. If any terms are finally held or determined to be invalid, illegal or void, the Parties shall enter into negotiations concerning the terms affected by such decision for the purpose of achieving conformity with requirements of any applicable law and the intent of the Parties to this Agreement.

SECTION 18: WAIVER

Any waiver at any time by either Party of its rights with respect to a default under this Agreement or with respect to any other matters arising in connection with this Agreement must be in writing, and such waiver shall not be deemed a waiver with respect to any subsequent default or other matter.

SECTION 19: GOVERNMENTAL JURISDICTIONS AND AUTHORIZATIONS

This Agreement is subject to the jurisdiction of those governmental agencies having control over either Party or this Agreement. Seller shall at all times maintain in effect all local, state and federal licenses, permits and other approvals as then may be required by law for the construction,

operation and maintenance of the Facility, and shall provide upon request copies of the same to PacifiCorp.

SECTION 20: REPEAL OF PURPA

This Agreement shall not terminate upon the repeal of the PURPA, unless such termination is mandated by federal or state law.

SECTION 21: SUCCESSORS AND ASSIGNS

This Agreement and all of the terms hereof shall be binding upon and inure to the benefit of the respective successors and assigns of the Parties. No assignment hereof by either Party shall become effective without the written consent of the other Party being first obtained and such consent shall not be unreasonably withheld, conditioned or delayed. Notwithstanding the foregoing, either Party may assign this Agreement without the other Party's consent to a lender as part of a financing transaction or as part of (a) a sale of all or substantially all of the assigning Party's assets, or (b) a merger, consolidation or other reorganization of the assigning Party.

SECTION 22: ENTIRE AGREEMENT

22.1 This Agreement supersedes all prior agreements, proposals, representations, negotiations, discussions or letters, whether oral or in writing, regarding PacifiCorp's purchase of Net Output from the Facility. No modification of this Agreement shall be effective unless it is in writing and signed by both Parties.

22.2 By executing this Agreement, Seller releases PacifiCorp from any claims, known or unknown, that may have arisen prior to the Effective Date.

SECTION 23: NOTICES

23.1 All notices except as otherwise provided in this Agreement shall be in writing, shall be directed as follows and shall be considered delivered if delivered in person or when deposited in the U.S. Mail, postage prepaid by certified or registered mail and return receipt requested.

Notices	PacifiCorp	Seller
All Notices	PacifiCorp 825 NE Multnomah Street Portland, OR 97232 Attn: Contract Administration, Suite 600 Phone: (503) 813 - 5380 Facsimile: (503) 813 - 6291 Duns: 00-790-9013 Federal Tax ID Number: 93-0246090	Obsidian Renewables, LLC 5 Centerpointe Dr. Suite 590 Lake Oswego, OR 97035 Phone: 503-245-8800 Fax: 503-245-8804 Duns:

Notices	PacifiCorp	Seller
		Federal Tax ID: 27-0445531
All Invoices:	(same as street address above) Attn: Back Office, Suite 700 Phone: (503) 813 - 5578 Facsimile: (503) 813 - 5580	Obsidian Renewables, LLC 5 Centerpointe Dr. Suite 590 Lake Oswego, OR 97035
Scheduling:	(same as street address above) Attn: Resource Planning, Suite 600 Phone: (503) 813 - 6090 Facsimile: (503) 813 - 6265	Obsidian Renewables, LLC 5 Centerpointe Dr. Suite 590 Lake Oswego, OR 97035
Payments:	(same as street address above) Attn: Back Office, Suite 700 Phone: (503) 813 - 5578 Facsimile: (503) 813 - 5580	Obsidian Renewables, LLC 5 Centerpointe Dr. Suite 590 Lake Oswego, OR 97035
Wire Transfer:	Bank One N.A. ABA: ACCT: NAME: PacifiCorp Wholesale	
Credit and Collections:	(same as street address above) Attn: Credit Manager, Suite 1900 Phone: (503) 813 - 5684 Facsimile: (503) 813 - 5609	Obsidian Renewables, LLC 5 Centerpointe Dr. Suite 590 Lake Oswego, OR 97035
With Additional Notices of an Event of Default or Potential Event of Default to:	(same as street address above) Attn: PacifiCorp General Counsel Phone: (503) 813-5029 Facsimile: (503) 813-7252	David J. Petersen Tonkon Torp LLP Chair, Energy Practice Group 1600 Pioneer Tower 888 SW Fifth Avenue Portland, Oregon 97204 (503) 802-2054 FAX (503) 972-3754 david.petersen@tonkon.com

23.2 The Parties may change the person to whom such notices are addressed, or their addresses, by providing written notices thereof in accordance with this Section 23.

IN WITNESS WHEREOF, the Parties hereto have caused this Agreement to be executed in their respective names as of the date first above written.

PacifiCorp

By: _____

Name: Bruce Griswold

Title: Director, Short Term Origination
and QF Contracts

BWS 7-25-2014

Seller: Obsidian Renewables, LLC

By: _____

Name: David W. Brown

Title: Senior Principal

EXHIBIT A
DESCRIPTION OF SELLER'S FACILITY
[Seller to Complete]

Seller's Facility consists of a 7 MWac solar photovoltaic project including approximately 30,020 PV panels, inverters, and single axis tracker system. More specifically, the inverter at the Facility is described as:

Number of Inverters: 7

Model: Utility Inverter AC1000NX, or similar

Number of Phases: 3

Rated Output (kW): 7,000 **Rated Output (kVA):** 7,700

Rated Voltage (line to line): 12.47 kV

Maximum kW Output: 6915 **Maximum kVA Output:** 7606 kVA

Minimum kW Output: 0

Annual Facility Degradation Rate: .7%

Facility Capacity Rating: 7,000 kW, 6,915 after transformer and other losses.

Identify the maximum output of the inverter (s) and describe any differences between that output and the Nameplate Capacity Rating: Maximum output is 1,000 kW for each inverter.

Station service requirements, and other loads served by the Facility, if any, are described as follows: Generator (panel) output is 9,126 kW at STC.

There will be PV system losses (DC side), inverter losses, and inverter output is capped at 7,000 kW AC.

Transformer: 1.2 %, Tracker Motor .1 %, Data Acquisition and Aux Loads .1 %

Values above are percentage loss of Total output and losses are already accounted for in the expected output in Exhibit D-1.

Location of the Facility: The Facility is to be constructed in the vicinity of Sprague River in Klamath County, Oregon. The location is more particularly described as follows:

The site is between the Town of Sprague River and Beatty, north of Sprague River Road, Site coordinates are 42.440, -121.440. The project will be located on Tax Lots 400, 500 and 600 in Section 17 of Township 36S Range 11 E W.M.

Power factor requirements:

Rated Power Factor (PF) or reactive load (kVAR): PV system is capable to deliver and absorb reactive power to maintain power factor within 0.95 lagging through 0.95 leading power factor.

A more detailed and updated Exhibit A will be provided per section 6.1

EXHIBIT B

SELLER'S INTERCONNECTION FACILITIES

[Seller to provide its own diagram and description]

POINT OF DELIVERY / SELLER'S INTERCONNECTION FACILITIES

Instructions to Seller:

1. Include description of point of metering, and Point of Delivery
2. Provide interconnection single line drawing of Facility including any transmission facilities on Seller's side of the Point of Delivery.

1. Point of Delivery is at adjacent Circuit 5L8, a 12 kv feeder out of Sprague River Substation. Point of Metering is at metal clad switchgear, E2.0.

2. The one-line diagram of the solar facility is attached. Attached area site map shows the distance between proposed Sprague River, Beatty (QF application pending) and Ivory Pine projects.

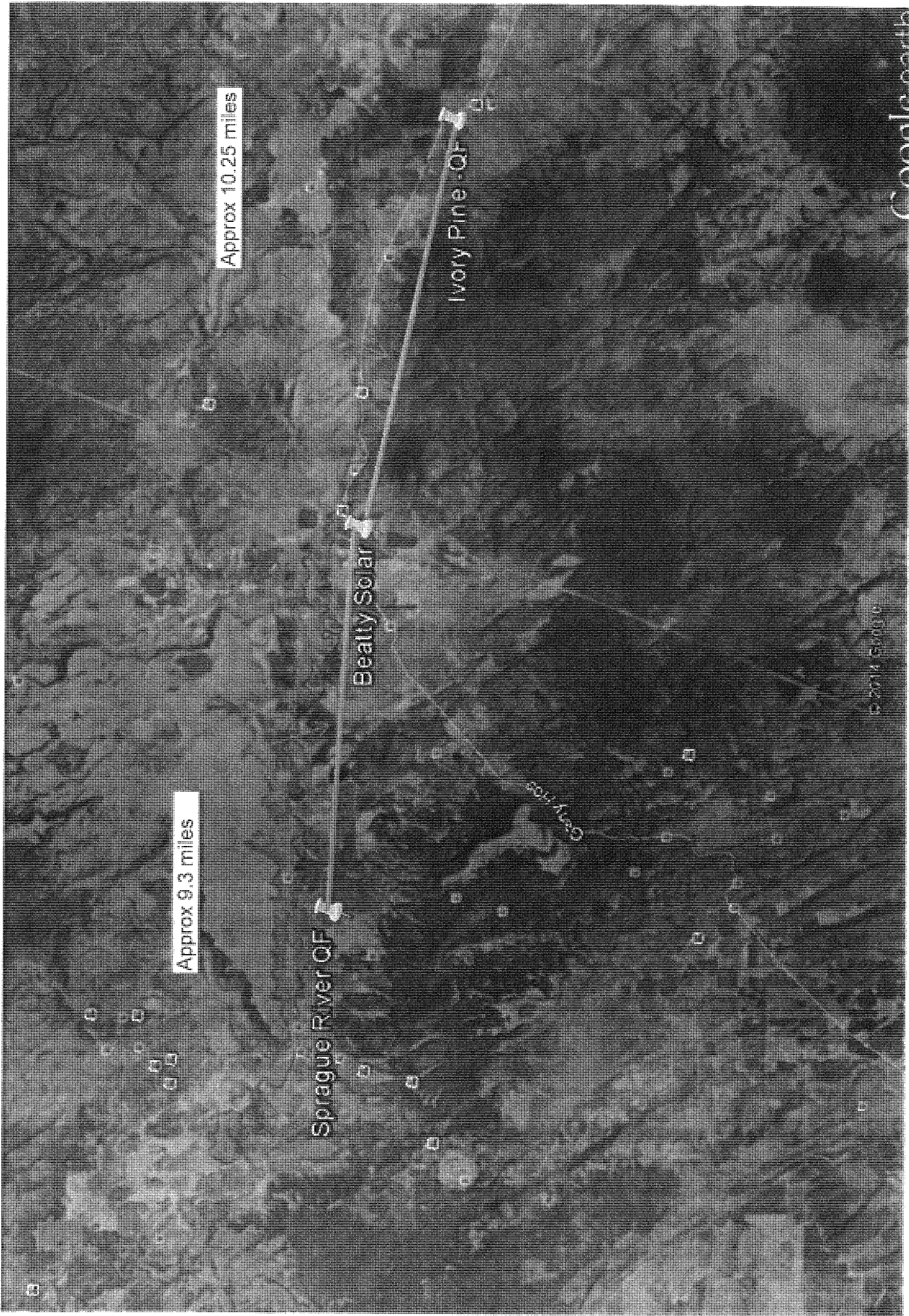

Approx 9.3 miles

Approx 10.25 miles

Sprague River QF

Beatty Solar

Ivory Pine QF

© 2014 Google

Google Earth

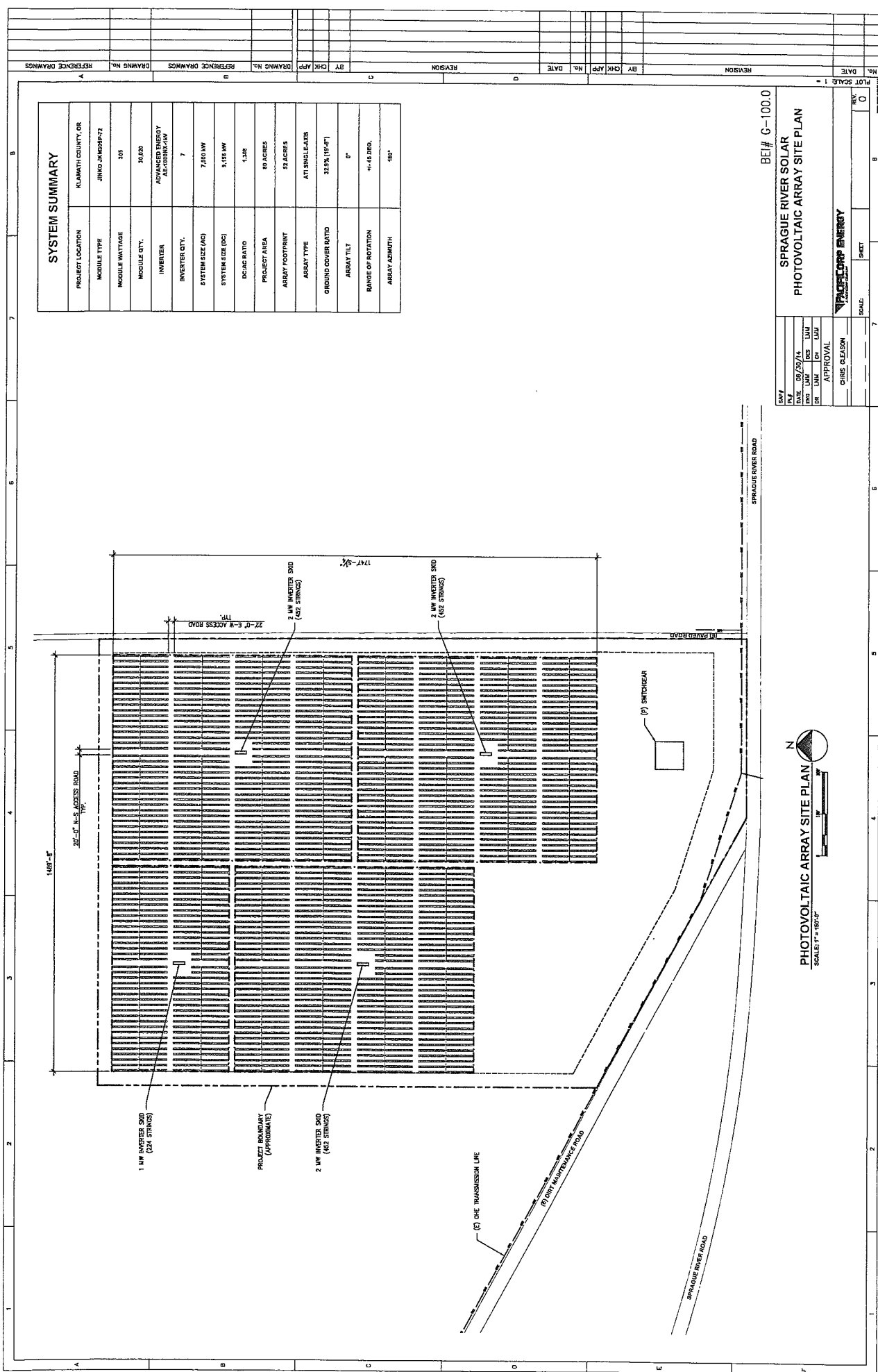

SYSTEM SUMMARY	
PROJECT LOCATION	KUAWATH COUNTY, OR
MODULE TYPE	JINKO JKM60S42Z
MODULE WATTAGE	305
MODULE QTY.	30,000
INVERTER	ADVANCED ENERGY AE-1500NS-114V
INVERTER QTY.	7
SYSTEM SIZE (AC)	7,600 MW
SYSTEM SIZE (DC)	5,156 MW
DC/AC RATIO	1.300
PROJECT AREA	80 ACRES
ARRAY FOOTPRINT	52 ACRES
ARRAY TYPE	ATI SINGLE-AXIS
GROUND COVER RATIO	32.5% (19'-6")
ARRAY TILT	0°
RANGE OF ROTATION	+/- 0 DEG.
ARRAY AZIMUTH	180°

BEI# G-100.0

**SPRAGUE RIVER SOLAR
PHOTOVOLTAIC ARRAY SITE PLAN**

DATE	05/20/14	DATE	05/20/14
DESIGN	UM	DESIGN	UM
DR	UM	DR	UM
APPROVAL			
CHRIS GLEASON			

PACIFIC CORP ENERGY
INCORPORATED

SCALE: _____ SHEET: _____

PHOTOVOLTAIC ARRAY SITE PLAN
SCALE: 1" = 160'-0"

LOT SCALE: 1" = 160'-0"

NO. DATE REVISION

BY: _____

CHK: _____

APP: _____

NO. DATE

BY: _____

CHK: _____

APP: _____

NO. DATE

BY: _____

CHK: _____

APP: _____

NO. DATE

BY: _____

CHK: _____

APP: _____

NO.	DATE	REVISION	BY	CHK/APP	NO.	DATE	REVISION	BY	CHK/APP	NO.	DATE	REVISION	BY	CHK/APP	
REFERENCE DRAWINGS															

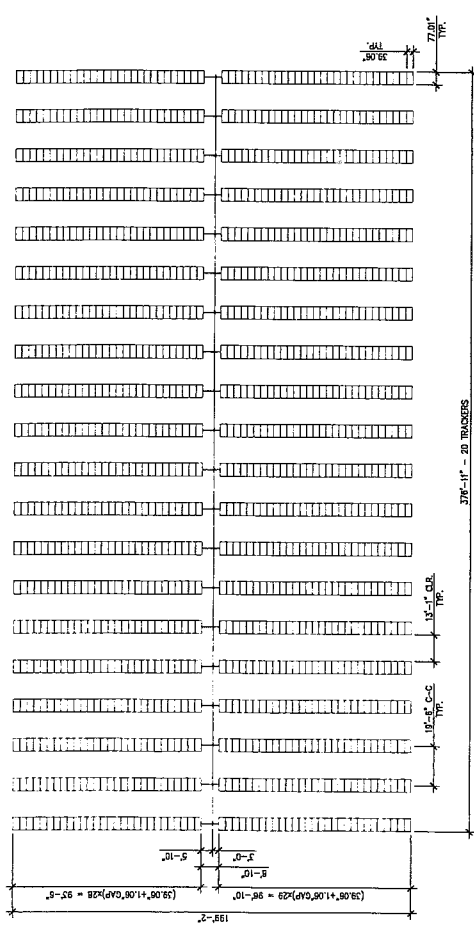
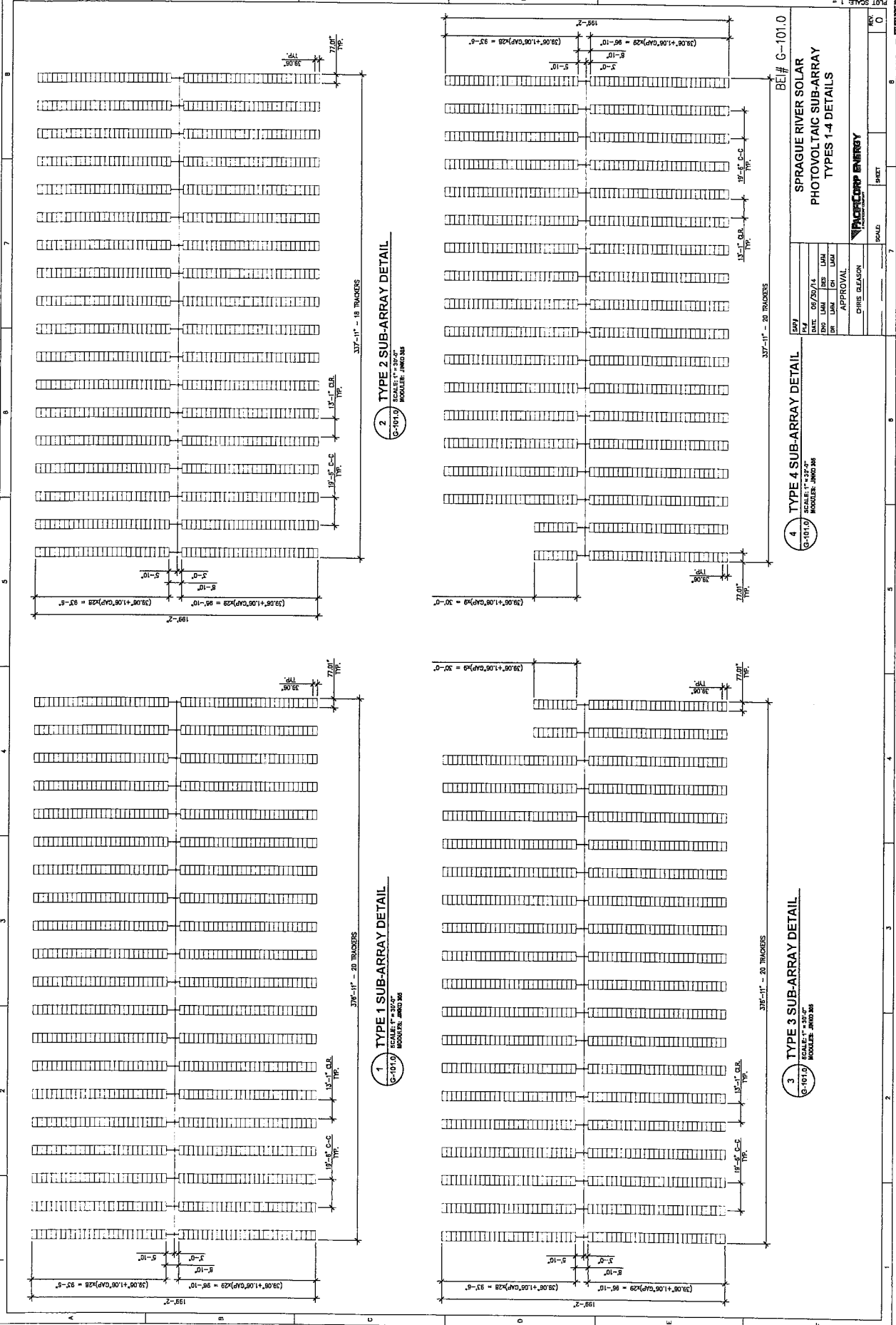

1 TYPE 1 SUB-ARRAY DETAIL
G-101.0 SCALE: 1" = 30'-0"
MODULE: JMK03M

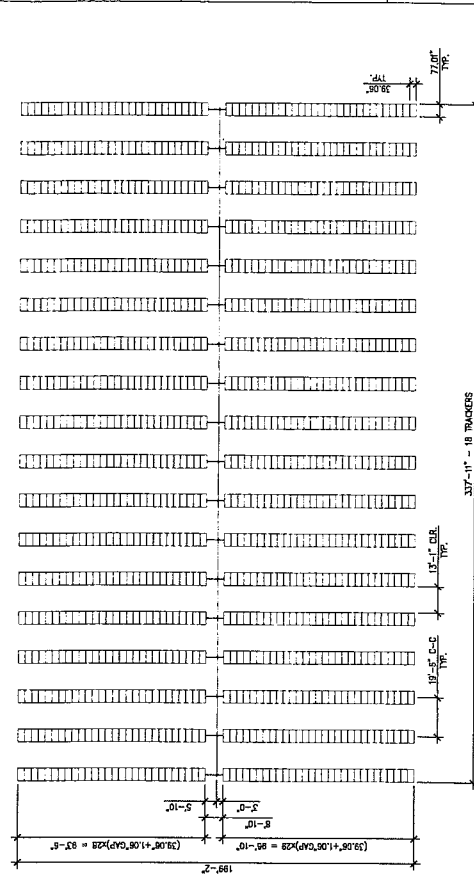

2 TYPE 2 SUB-ARRAY DETAIL
G-101.0 SCALE: 1" = 30'-0"
MODULE: JMK03M

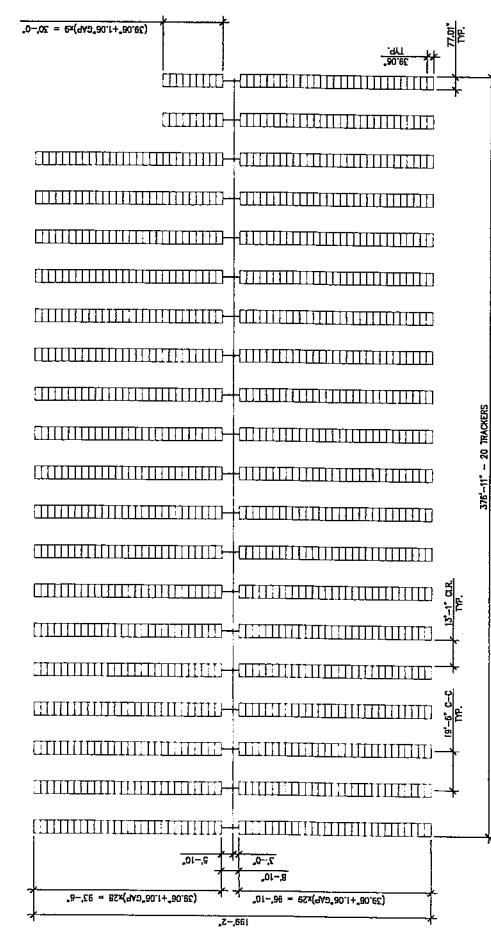

3 TYPE 3 SUB-ARRAY DETAIL
G-101.0 SCALE: 1" = 30'-0"
MODULE: JMK03M

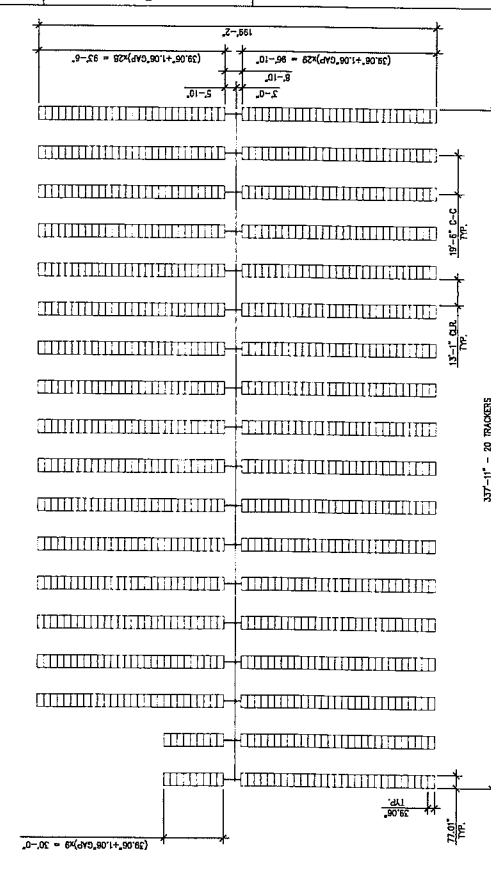

4 TYPE 4 SUB-ARRAY DETAIL
G-101.0 SCALE: 1" = 30'-0"
MODULE: JMK03M

BEI# G-101.0

SPRAGUE RIVER SOLAR
PHOTOVOLTAIC SUB-ARRAY
TYPES 1-4 DETAILS

DATE	05/20/14	DES	UM
ENG	UM	CHK	UM
APP	UM	APPROVAL	
CHRS BEAZON			

PACIFIC CORP ENERGY

SHEET

7

8

9

10

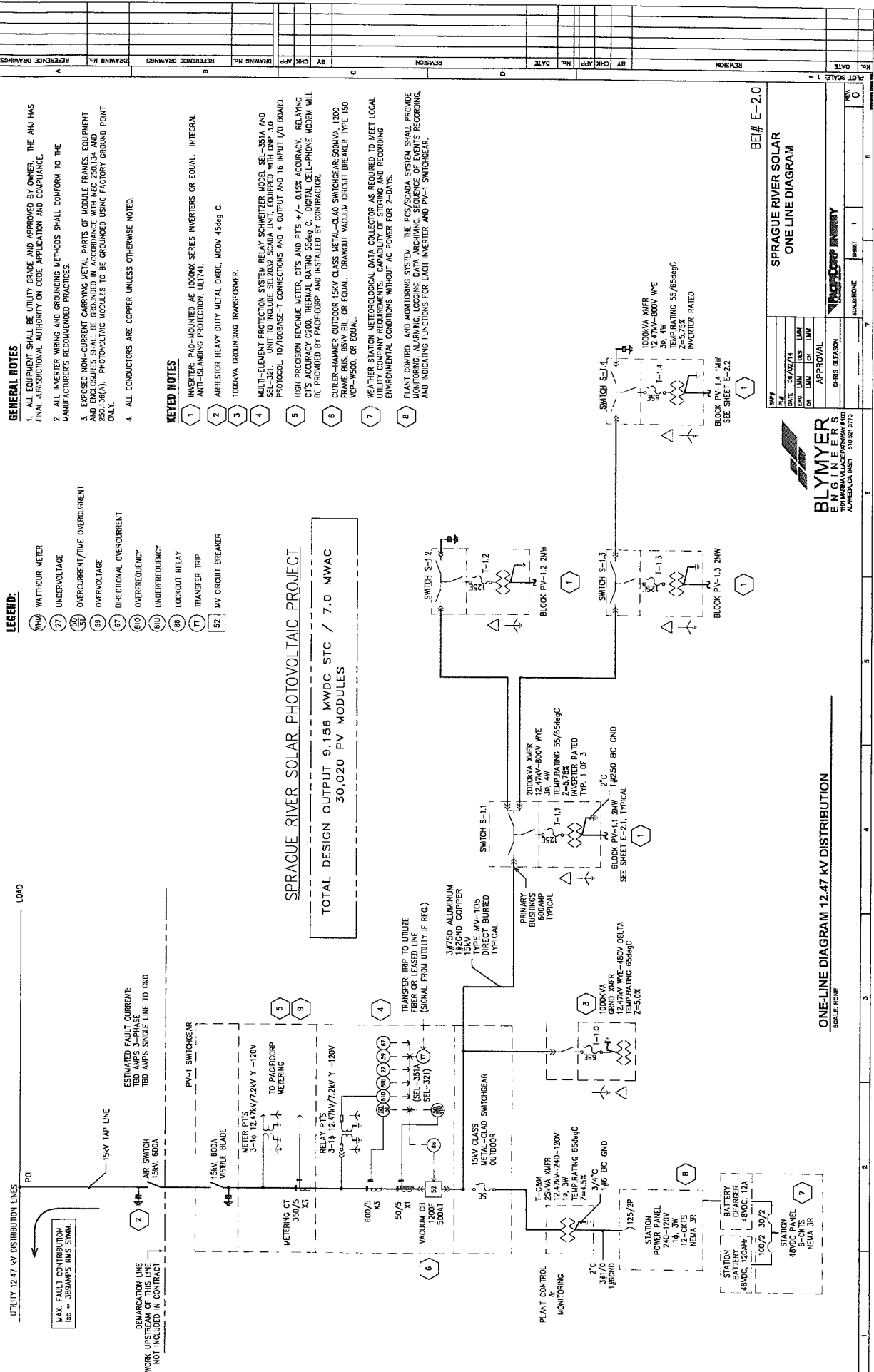

GENERAL NOTES

1. ALL EQUIPMENT SHALL BE UTILITY GRADE AND APPROVED BY OWNER. THE AHI HAS FINAL JURISDICTIONAL AUTHORITY ON CODE APPLICATION AND COMPLIANCE.
2. ALL INVERTER WIRING AND GROUNDING METHODS SHALL CONFORM TO THE MANUFACTURER'S RECOMMENDED PRACTICES.
3. EXPOSED NON-CURRENT CARRYING METAL PARTS OF MODULE FRAMES, EQUIPMENT AND ENCLOSURES SHALL BE GROUNDED IN ACCORDANCE WITH NEC 250.134 AND 250.136(A). PHOTOVOLTAIC MODULES TO BE GROUNDED USING FACTORY GROUND POINT GALT.
4. ALL CONDUCTORS ARE COPPER UNLESS OTHERWISE NOTED.

LEGEND:

- (1) WATTHOUR METER
- (2) UNDERVOLTAGE
- (3) OVERCURRENT/TIME OVERCURRENT
- (4) OVERVOLTAGE
- (5) DIRECTIONAL OVERCURRENT
- (6) OVERFREQUENCY
- (7) UNDERFREQUENCY
- (8) LOCKOUT RELAY
- (9) TRANSFER TRIP
- (10) 52.1 MV CIRCUIT BREAKER

SPRAGUE RIVER SOLAR PHOTOVOLTAIC PROJECT

TOTAL DESIGN OUTPUT 9,156 MWDC STC / 7.0 MWAC
30,020 PV MODULES

KEYED NOTES

1. INVERTER, PAD-MOUNTED AS 1000kVA SERIES INVERTERS OR EQUAL. INTEGRAL ANTI-ISLANDING PROTECTION, UL1741.
2. ARRESTOR HEAVY DUTY METAL OXIDE, MCOV 45kVg C.
3. 1000kVA GROUNDING TRANSFORMER.
4. MULT-ELEVENTY PROTECTION SYSTEM RELAY SWITCHER MODEL SEL-351A AND SEL-321. UNIT TO INCLUDE SEL-320X SCADA UNIT EQUIPPED WITH OSP, A PROTOCOL 10/10BASE-T CONNECTIONS AND 4 OUTPUT AND 16 INPUT I/O BOARD.
5. HIGH PRECISION REVENUE METER, CTS AND P.T'S +/- 0.15% ACCURACY. RELAYING C.T'S ACCURACY C200, THERMAL RATING 3500g C. DIGITAL CELL-PHONE MODEM WILL BE PROVIDED BY PACIFICORP AND INSTALLED BY CONTRACTOR.
6. OUTER-HAMMER OUTDOOR 15KV CLASS METAL-CLAD SWITCHGEAR: 500MVA, 1200 FRAME BUS, 85kV BIL, OR EQUAL. DRAWOUT VACUUM CIRCUIT BREAKER TYPE 150 VCP-1W500, OR EQUAL.
7. WEATHER STATION METEOROLOGICAL DATA COLLECTOR AS REQUIRED TO MEET LOCAL UTILITY COMPANY REQUIREMENTS. CAPABILITY OF STORING AND RECORDING ENVIRONMENTAL CONDITIONS WITHOUT AC POWER FOR 2-DAYS.
8. PLANT CONTROL AND MONITORING SYSTEM. THE PCS/SCADA SYSTEM SHALL PROVIDE MONITORING, ALARMING, LOGGING, DATA ARCHIVING, SEQUENCE OF EVENTS RECORDING, AND INDICATING FUNCTIONS FOR EACH INVERTER AND PV-1 SWITCHGEAR.

BEI# E-2.0

**SPRAGUE RIVER SOLAR
ONE LINE DIAGRAM**

DATE	05/02/14	DATE	
BY	LM	BY	LM
CHK	LM	CHK	LM
APP		APP	
APPROVAL			
CHRS. REASON			

BLYMYER ENGINEERS
AN AMERICAL GROUP 510.921.9713

PROJECT NO. SHEET 1 OF 0

ONE-LINE DIAGRAM 12.47 kV DISTRIBUTION

SCALE: NONE

GENERAL NOTES

1. ALL EQUIPMENT SHALL BE UTILITY GRADE AND APPROVED BY OWNER. IT IS THE FINAL JURISDICTIONAL AUTHORITY ON CODE APPLICATION AND COMPLIANCE.
2. ALL INVERTER WIRING AND GROUNDING METHODS SHALL CONFORM TO THE MANUFACTURER'S RECOMMENDED PRACTICES.
3. ALL DC ISOLATION SWITCHES AND COMBINER BOXES SHALL BE LABELED "WARNING - ELECTRIC SHOCK HAZARD - DO NOT TOUCH TERMINALS" AND "TERMINALS ON BOTH LINE AND LOAD SIDES MAY BE ENERGIZED IN THE OPEN POSITION" PER NEC 690.71.
4. EXPOSED NON-CURRENT CARRYING METAL PARTS OF MODULE FRAMES, EQUIPMENT AND ENCLOSURES SHALL BE GROUNDED IN ACCORDANCE WITH NEC 250.134 AND 250.136(A). PHOTOVOLTAIC MODULES TO BE GROUNDED USING FACTORY GROUND POINT ONLY. ALL GROUND CONDUCTORS (EQUIPMENT FRAME, CIRCUIT, ETC.) SHALL BE BOND TO THE SAME COMMON GROUND POINT.
5. ALL CONDUCTORS ARE COPPER UNLESS OTHERWISE NOTED. ALUMINUM CONDUCTORS ARE ALLOWED FROM COMBINER BOXES TO INVERTER RE-COMBINER.

KEYED NOTES

1. INVERTER: PAD-MOUNTED AE-1000VW SERIES INVERTERS OR EQUAL. INTEGRAL ANTI-ISLANDING PROTECTION, UL1741. FUSIBLE SUB-COMBINER AND DC DISCONNECT SWITCH REQUIRED.
2. 1000VDC RATED COMBINER BOX WITH INTEGRAL ISOLATION SWITCH, UL1741. FUSIBLE POSITIVE LEAD, TAMPERS EACH COMBINER DESIGNATED X.A.P.X AND NEGATIVE LEAD IN COMBINER X.X.N.X. "SURE PROTECTION CATEGORY I AND II DEVICES WITH VISUAL TRIP INDICATION."
3. PART OF PLANT CONTROL AND MONITORING SYSTEM (PCS/SCADA).
4. INTEGRAL ISOLATION SWITCH SHALL BE UL L LABELED AND APPROVED FOR ITS INTENDED USE. PROVIDE WARNING LABEL "WARNING - DO NOT OPERATE UNDER LOAD. SHUT DOWN INVERTER BEFORE OPERATING SWITCH."
5. TYPICAL STRUCTURE CONTAINS JINKO 305W PV MODULES. 19 MODULES WIRED IN SERIES AS 1 STRING FOR TOTAL 5.795 MWDC/STRING.
6. PROVIDE 2 EACH MINIMUM 20A-120VAC GFCI RECEPTACLES FOR MAINTENANCE OF INVERTERS AND CONTROL SYSTEM AT SHED LOCATION. COORDINATE POWER REQUIREMENTS WITH DAS PROVIDER.
7. INVERTER'S MANUFACTURER SHALL PROVIDE GROUND-FAULT PROTECTION. TOTAL VOLTAGE DROP FOR DC CIRCUITS SHALL NOT EXCEED 2%. OTHERWISE SIZE OF CONDUCTORS MAY HAVE TO BE INCREASED. CONTRACTOR SHALL NOTIFY ENGINEER IF ACTUAL VOLTAGE DROP IS TO EXCEED 2%.
8. NUMBER OF STRINGS ASSIGNED TO SPECIFIC COMBINER MAY VARY.

COMBINER BOX NAMING CONVENTION



ARRAYS CONFIGURATION

NUMBER OF STRINGS	ARRAY L1,L1	ARRAY L1,L2	ARRAY L1,L1	ARRAY L1,L2	ARRAY L1,L1	ARRAY L1,L2	ARRAY L1,L1	Total
NOVEMBER STRINGS	228	224	228	224	224	224	224	1568
PP-MODULES CITY	432	426	432	426	426	426	426	3070
ARRAYS DESIGNATION MAX	127,26	127,26	127,26	127,26	127,26	127,26	127,26	858.1

PHOTOVOLTAIC MODULE

Watts	Vmp	Voc	Imp	Isc	Module	
300	34.6	45.4	8.91	9.30	JINKO	
19	662.2	804.1	15	16.02	JINKO	
PV modules		String Vmp	String Voc	Lower Temp	Ambient Corr.	String Voc
19		662.2	804.1	-35.0 C	1.058	887.5

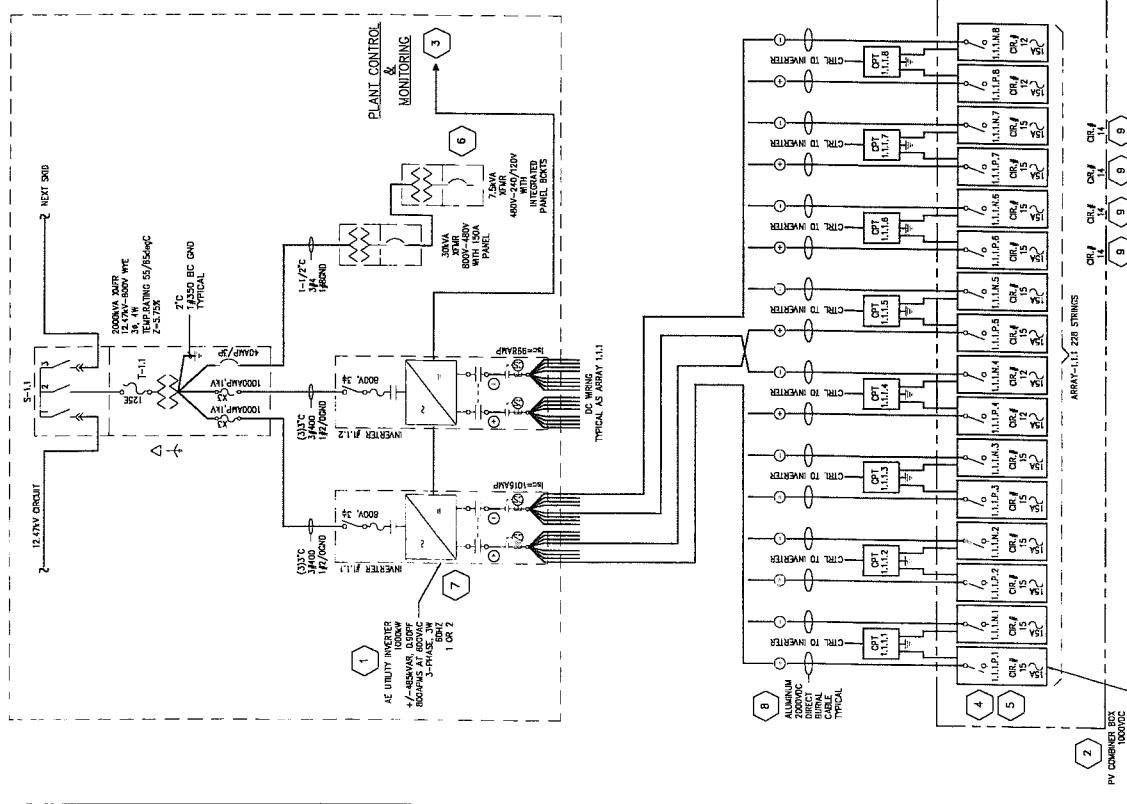

2 X 1000KW INVERTERS, 1000VDC BIPOLAR PHOTOVOLTAIC ARRAYS, PV MODULES JINKO 305P-72

DATE: 06/07/2014
 DWG: LUM
 DES: LUM
 APPR: LUM
 CHECK: LUM
 APPROVAL: [Signature]
 CHRS: CEASAR

PROJECT NAME: SPRAGUE RIVER SOLAR SCHEMATIC AC/DC SYSTEM SCHEMATIC PHOTOVOLTAIC BLOCK

SHEET: 2 OF 2

REV: 0

BLMYER ENGINEERS
 1000 W. 10TH AVE. SUITE 300
 DENVER, CO 80202

PRELIMINARY

BE# E-2.1

NO.	DATE	REVISION	BY	CHK	APP	NO.	DATE

GENERAL NOTES

- ALL EQUIPMENT SHALL BE UTILITY GRADE AND APPROVED BY OWNER. THE MANUFACTURER'S RECOMMENDED PRACTICES SHALL CONFORM TO THE MANUFACTURER'S RECOMMENDED PRACTICES.
- ALL INVERTER WIRING AND GROUNDING METHODS SHALL CONFORM TO THE MANUFACTURER'S RECOMMENDED PRACTICES.
- ALL DC ISOLATION SWITCHES AND COMBINER BOXES SHALL BE LABELED "WARNING - ELECTRIC SHOCK HAZARD - DO NOT TOUCH TERMINALS" AND "TERMINALS ON BOTH LINE AND LOAD SIDES MAY BE ENERGIZED IN THE OPEN POSITION" PER NEC 900.17.
- EXPOSED NON-CURRENT CARRYING METAL PARTS OF MODULE FRAMES, EQUIPMENT AND ENCLOSURES SHALL BE GROUNDED IN ACCORDANCE WITH NEC 250.134 AND 250.136(A). PHOTOVOLTAIC MODULES TO BE GROUNDED USING FACTORY GROUND POINT ONLY. ALL GROUND CONDUCTORS (EQUIPMENT FRAME, CIRCUIT, ETC.) SHALL BE BONDED TO THE SAME COMMON GROUND POINT.
- ALL CONDUCTORS ARE COPPER UNLESS OTHERWISE NOTED. ALUMINUM CONDUCTORS ARE ALLOWED FROM COMBINER BOXES TO INVERTER RE-COMBINER.

KEYED NOTES

- INVERTER: PAD-MOUNTED AE-1000KW SERIES INVERTERS OR EQUAL. INTEGRAL ANTI-ISLANDING PROTECTION, UL1741, FUSIBLE SUB-COMBINER AND DC DISCONNECT SWITCH REQUIRED.
- 1000VDC RATED COMBINER BOX WITH INTEGRAL ISOLATION SWITCH, UL1741, FUSIBLE POSITIVE LEAD, ISAMPS EACH COMBINER DESIGNATED X.X.X.P.X AND NEGATIVE LEAD IN COMBINER X.X.X.X.X. SURGE PROTECTION CATEGORY I AND II DEVICES WITH VISUAL TRIP INDICATOR.
- PART OF PLANT CONTROL AND MONITORING SYSTEM (PCS/SCADA).
- INTEGRAL ISOLATION SWITCH SHALL BE UL1741 LABELED AND APPROVED FOR ITS INTENDED USE. PROVIDE WARNING LABEL "WARNING - DO NOT OPERATE UNDER LOAD, SHUT DOWN INVERTER BEFORE OPERATING SWITCH".
- TYPICAL STRUCTURE CONTAINS JINKO 300W PV MODULES. 19 MODULES WIRED IN SERIES AS 1 STRING FOR TOTAL 5.795 kWDC/STRING.
- PROVIDE 2 EACH MINIMUM 20A-120VAC GFCI RECEPTACLES FOR MAINTENANCE OF INVERTERS AND CONTROL SYSTEM AT SMD LOCATION. COORDINATE POWER REQUIREMENTS WITH DAS PROVIDER.
- INVERTER'S MANUFACTURER SHALL PROVIDE GROUND-FAULT PROTECTION TOTAL VOLTAGE DROP FOR DC CIRCUITS SHALL NOT EXCEED 2%. OTHERWISE SIZE OF CONDUCTORS MAY HAVE TO BE INCREASED. CONTRACTOR SHALL NOTIFY ENGINEER IF CURRENT RIDDING EXCEEDS THE DESIGNATED MAXIMUM ONE-WAY DISTANCE AS IS SHOWN IN WIRE AND CONDUIT SCHEDULES.

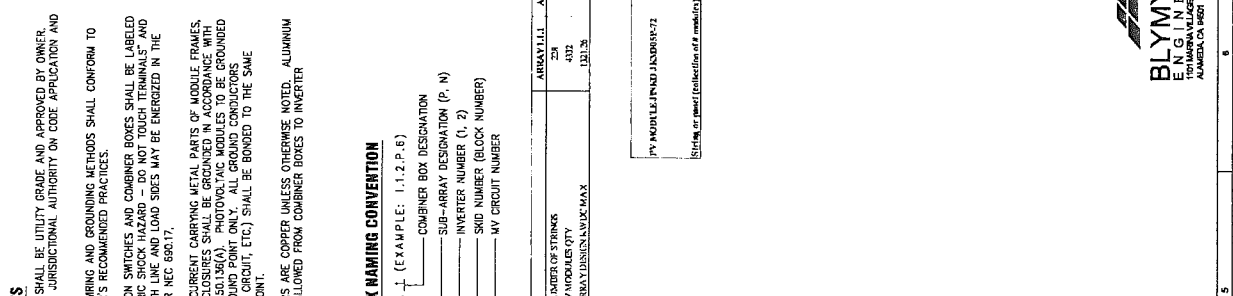

COMBINER BOX NAMING CONVENTION

(EXAMPLE: 1.1.2.P.6)

- COMBINER BOX DESIGNATION
- SUB-ARRAY DESIGNATION (P, H)
- INVERTER NUMBER (1, 2)
- SKID NUMBER (BLOCK NUMBER)
- VV CIRCUIT NUMBER

ARRAYS CONFIGURATION

INVERTER OF STRINGS	ARRAY 1.1.1	ARRAY 1.1.2	ARRAY 1.1.3	ARRAY 1.1.4	ARRAY 1.1.5	ARRAY 1.1.6	ARRAY 1.1.7	ARRAY 1.1.8	ARRAY 1.1.9	ARRAY 1.1.10	ARRAY 1.1.11	ARRAY 1.1.12	ARRAY 1.1.13	ARRAY 1.1.14	ARRAY 1.1.15	ARRAY 1.1.16	ARRAY 1.1.17	ARRAY 1.1.18	ARRAY 1.1.19	ARRAY 1.1.20	ARRAY 1.1.21	ARRAY 1.1.22	ARRAY 1.1.23	ARRAY 1.1.24	Total
PV MODULES QTY	238	238	238	238	238	238	238	238	238	238	238	238	238	238	238	238	238	238	238	238	238	238	238	238	5710
ARRAY DESIGNATION MAX	4332	4332	4332	4332	4332	4332	4332	4332	4332	4332	4332	4332	4332	4332	4332	4332	4332	4332	4332	4332	4332	4332	4332	4332	129600
	1201.36	1201.36	1201.36	1201.36	1201.36	1201.36	1201.36	1201.36	1201.36	1201.36	1201.36	1201.36	1201.36	1201.36	1201.36	1201.36	1201.36	1201.36	1201.36	1201.36	1201.36	1201.36	1201.36	1201.36	30000

PHOTOVOLTAIC MODULE

Watts	Vmp	Voc	Imp	Isc	Max Power	Temp. Coeff. (Pmax)	Temp. Coeff. (Voc)	Temp. Coeff. (Isc)
305	36.8	45.6	8.20	8.91	300W	-0.46%	-0.23%	0.06%

PV Modules: 19
String Voltage: 695.2 VDC
Maximum Power: 5710 W
Minimum Power: 4332 W
Temperature: 25°C
Ambient Temp. Range: -20 to 50°C
Sizing Voltage: 1147 VDC
Sizing Current: 892.5 A

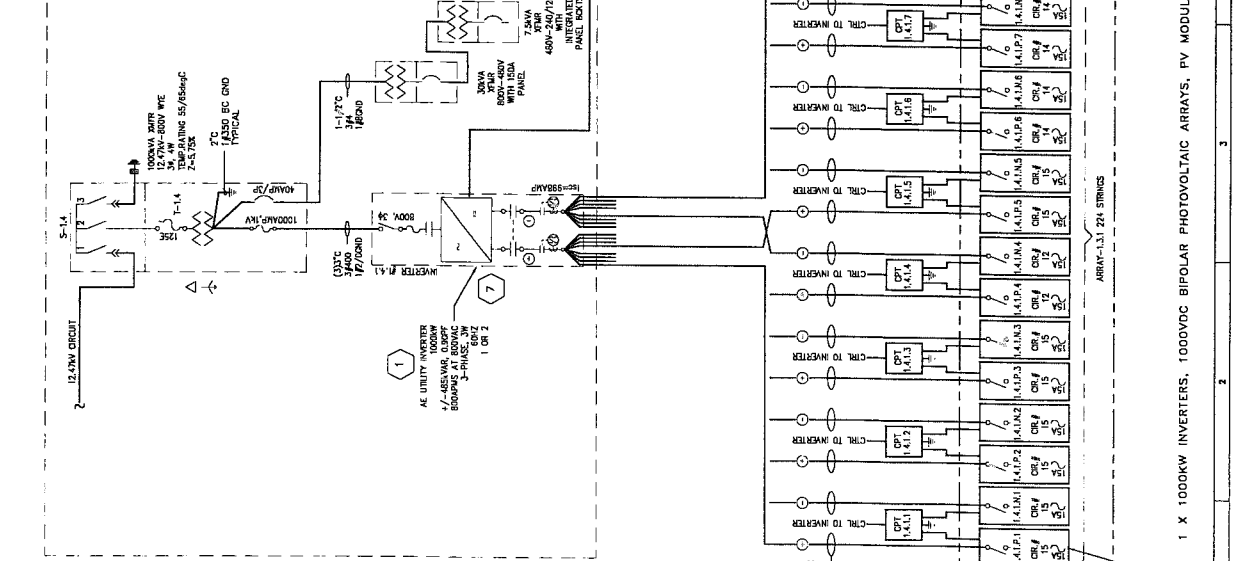

1 X 1000KW INVERTERS, 1000VDC BIPOLAR PHOTOVOLTAIC ARRAYS, PV MODULES JINKO 305P-72

EXHIBIT C
REQUIRED FACILITY DOCUMENTS

REQUIRED OF ALL FACILITIES:

QF Certification: QF14-515-000

Interconnection Agreement: To be provided October 31, 2015

Fuel Supply Agreement, if applicable: NA

Retail Electric Service Agreement

Land Lease or Deed: _Lease Option Agreement with Duane Martin Ranches LP dated July 3, 2014 has been provided.

Permits:

County Conditional Use Permit

Building Permit

Electrical Permit

DEQ Construction Storm Water Permit

REQUIRED IF SELLER ELECTS TO GRANT SENIOR LIEN OR STEP-IN RIGHTS:

Deed or Lease to Facility Premises: _ Lease Option Agreement dated July 3, 2014 is attached. _____

Proof of site control of Facility. See attached Lease Option

Off-take sale agreements, e.g. surplus heat sale contract, if applicable – Not applicable

Depending upon the type of Facility and its specific characteristics, additional Required Facility Documents may be requested.

**EXHIBIT D-1
SELLER'S MOTIVE FORCE PLAN**

A. MONTHLY DELIVERY SCHEDULES AND SCHEDULED MAINTENANCE

Month	Average Energy (kWh)
January	687,000
February	796,000
March	953,000
April	1,737,000
May	2,066,000
June	2,281,000
July	2,389,000
August	2,308,000
September	1,744,000
October	1,201,000
November	690,000
December	665,000

Seller provide an estimate of the average monthly Net Output of the Facility, and explain the basis for the estimate.

B. MINIMUM ANNUAL DELIVERY CALCULATION

Seller specify the Minimum Annual Delivery of the Facility, and explain the basis for the estimate. NOTE: The Minimum Annual Delivery should be based on the most adverse natural motive force conditions reasonably expected and should take into account maintenance and Seller's load (if any). Minimum generation is 7,007,000 KWH based on 40% of the average generation.

For the purpose of calculating Minimum Net Output during partial contract years, pro rata estimates would be seasonally adjusted based on monthly estimates contained in Section A.

C. MAXIMUM ANNUAL DELIVERY CALCULATION

Seller specify the estimated Maximum Annual Delivery of the Facility, and explain the basis for the estimate. Maximum generation is 21,900,000 KWH based on 125% of the average generation.

EXHIBIT D-2
ENGINEER'S CERTIFICATION
OF
MOTIVE FORCE PLAN

Seller provide a written declaration from a Licensed Professional Engineer to PacifiCorp that the Facility is likely capable under average conditions foreseeable during the term of this Agreement of meeting Seller's estimated average, maximum, and minimum Net Output.

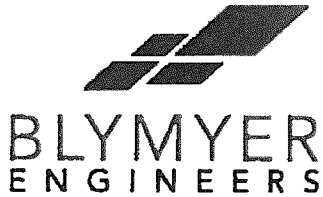

1101 Marina Village Parkway
Suite 100
Alameda, CA 94501
P 510.521.3773
F 510.865.2594

Date: July 03, 2014

PacifiCorp

REF: Sprague River Solar - EXHIBIT D-1

This letter is to declare that the Sprague River Solar Facility is likely capable under average conditions foreseeable during the term of this Agreement of meeting Seller's estimated average, maximum, and minimum Net Output.

Sincerely,

Lech M. Majerski, P.E.
Blymyer Engineers, Inc.
lmajerski@blymyer.com

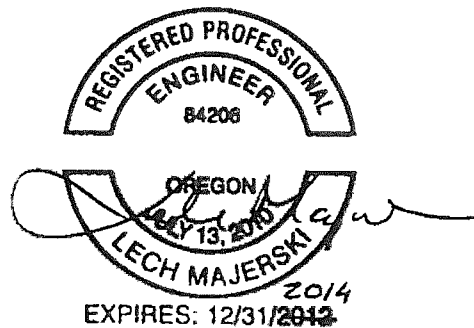

Grid-Connected System: Simulation parameters

Project : **Swinerton Sprague River**

Geographical Site **Klamath Falls Intl Ap [uo] 2010** **Country** **United States**

Situation Latitude 42.2°N Longitude 121.7°W
 Time defined as Legal Time Time zone UT-8 Altitude 1220 m
 Albedo 0.20

Meteo data : Klamath Falls Intl Ap [uo] 2010

Simulation variant : **2014 07 07**

Simulation date 07/07/14 15h03

Simulation parameters

Tracking plane, tilted Axis Axis Tilt 0° Axis Azimuth 0°
 Rotation Limitations Minimum Phi -45° Maximum Phi 45°

Backtracking strategy Tracker Spacing 5.94 m Collector width 1.95 m
 Inactive band Left 0.01 m Right 0.01 m

Models used Transposition Perez Diffuse Measured

Horizon Free Horizon

Near Shadings No Shadings

PV Array Characteristics

PV module Si-poly Model **JKM 305P-72**

Manufacturer Jinkosolar

Number of PV modules In series 38 modules In parallel 790 strings

Total number of PV modules Nb. modules 30020 Unit Nom. Power 305 Wp

Array global power Nominal (STC) **9156 kWp** At operating cond. 8206 kWp (50°C)

Array operating characteristics (50°C) U mpp +/-619 V I mpp 6629 A

Total area Module area **58249 m²** Cell area 52609 m²

Inverter

Model **AE 1000NX- 800VAC MFG**

Manufacturer Advanced Energy Industries, Inc.

Characteristics Operating Voltage +/-550-1000 V Unit Nom. Power 1000 kW AC

Inverter pack Number of Inverter 7 units Total Power 7000 kW AC

PV Array loss factors

Thermal Loss factor Uc (const) 29.0 W/m²K Uv (wind) 0.0 W/m²K / m/s
 => Nominal Oper. Coll. Temp. (G=800 W/m², Tamb=20°C, Wind=1 m/s.) NOCT 45 °C

Wiring Ohmic Loss Global array res. 4.2 mOhm Loss Fraction 2.0 % at STC

Array Soiling Losses Loss Fraction 2.0 %

Module Quality Loss Loss Fraction 1.5 %

Module Mismatch Losses Loss Fraction 1.0 % at MPP

Incidence effect, ASHRAE parametrization IAM = 1 - bo (1/cos i - 1) bo Parameter 0.05

Grid-Connected System: Simulation parameters (continued)

System loss factors

AC wire loss inverter to transfo	Inverter voltage	800 Vac tri		
	Wires	178 m 3x5000 mm ²	Loss Fraction	1.1 % at STC
External transformer	Iron loss (24H connection)	12580 W	Loss Fraction	0.1 % at STC
	Resistive/Inductive losses	0.8 mOhm	Loss Fraction	1.1 % at STC

User's needs :

Unlimited load (grid)

Grid-Connected System: Main results

Project : Swinerton Sprague River
Simulation variant : 2014 07 07

Main system parameters		System type	Grid-Connected	
PV Field Orientation	tracking, tilted axis, Axis Tilt	0°	Axis Azimuth	0°
PV modules	Model	JKM 305P-72	Pnom	305 Wp
PV Array	Nb. of modules	30020	Pnom total	9156 kWp
Inverter	Model	AE 1000NX- 800VAC MFG	Pnom	1000 kW ac
Inverter pack	Nb. of units	7.0	Pnom total	7000 kW ac
User's needs	Unlimited load (grid)			

Main simulation results
 System Production **Produced Energy 17519 MWh/year** Specific prod. 1913 kWh/kWp/year
 Performance Ratio PR **83.0 %**

Normalized productions (per installed kWp): Nominal power 9156 kWp

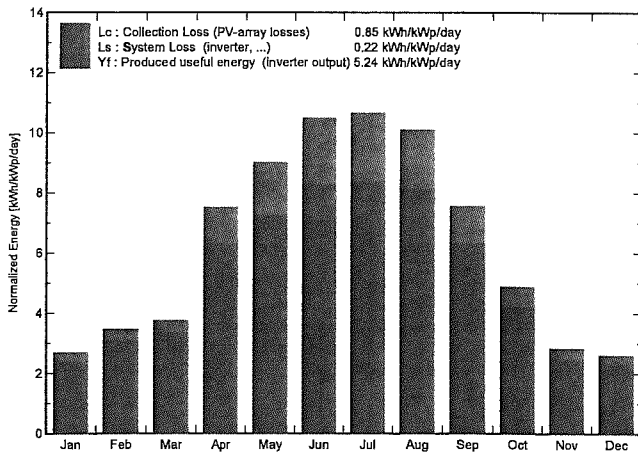

Performance Ratio PR

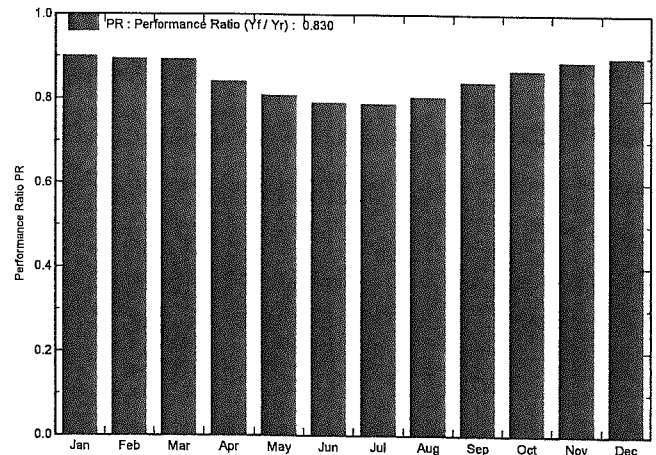

2014 07 07

Balances and main results

	GlobHor kWh/m²	T Amb °C	GlobInc kWh/m²	GlobEff kWh/m²	EArray MWh	E_Grid MWh	EffArrR %	EffSysR %
January	58.4	-0.80	83.4	79.8	720	687	14.82	14.15
February	72.4	2.85	97.3	93.8	832	796	14.69	14.06
March	94.7	2.10	116.6	113.2	996	953	14.66	14.04
April	167.7	7.19	225.8	221.3	1811	1737	13.77	13.21
May	208.9	10.66	279.6	274.8	2154	2066	13.23	12.69
June	233.9	15.85	314.9	310.4	2377	2281	12.96	12.43
July	245.2	20.31	330.8	326.3	2488	2389	12.91	12.40
August	223.3	19.53	313.1	308.7	2403	2308	13.18	12.65
September	159.6	12.95	226.6	222.3	1816	1744	13.75	13.21
October	106.1	7.15	151.2	147.1	1252	1201	14.22	13.64
November	60.8	1.64	84.8	81.3	723	690	14.63	13.97
December	57.0	-0.61	80.8	76.9	696	665	14.79	14.13
Year	1687.9	8.26	2304.9	2256.0	18268	17519	13.61	13.05

Legends: GlobHor Horizontal global irradiation EArray Effective energy at the output of the array
 T Amb Ambient Temperature E_Grid Energy injected into grid
 GlobInc Global incident in coll. plane EffArrR Effic. Eout array / rough area
 GlobEff Effective Global, corr. for IAM and shadings EffSysR Effic. Eout system / rough area

Grid-Connected System: Loss diagram

Project : Swinerton Sprague River
Simulation variant : 2014 07 07

Main system parameters	System type	Grid-Connected		
PV Field Orientation	tracking, tilted axis, Axis Tilt	0°	Axis Azimuth	0°
PV modules	Model	JKM 305P-72	Pnom	305 Wp
PV Array	Nb. of modules	30020	Pnom total	9156 kWp
Inverter	Model	AE 1000NX- 800VAC MFG	Pnom	1000 kW ac
Inverter pack	Nb. of units	7.0	Pnom total	7000 kW ac
User's needs	Unlimited load (grid)			

Loss diagram over the whole year

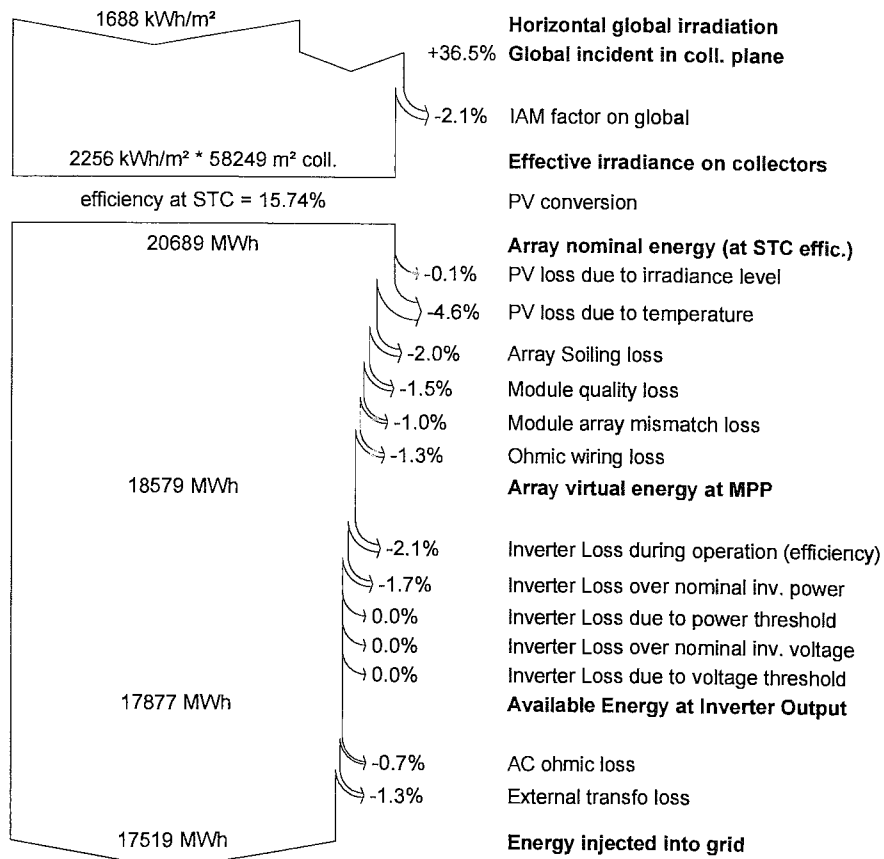

EXHIBIT E

START-UP TESTING

Start-Up Testing shall consist of the Quality Assurance/Quality Control plans and procedures developed by the EPC Contractor.

Contractor shall submit to Owner a final copy of its quality assurance/quality control (QA/QC) plan for review not later than 45 days after contract execution for Owner review and comment. The QA/QC program shall include, but is not limited to, such procedures and systems as the following:

- Road construction
- Rebar and conduit placement
- Concrete placement and testing
- All wire insulation testing—Megger testing or very low frequency testing
- Mechanical system—trackers, mounting structures, tracker controls
- Factory testing of inverters and transformers by the manufacturer
- PV source open-circuit measurements—VOC at combiner boxes
- Fuse tests
- Termination pull testing
- All visual inspections
- Grounding continuity testing
- Earth-ground resistivity testing
- PV module inspection and manufacturer documentation of factory test per the manufacturer's existing program
- Metering and instrumentation calibration testing
- Step-up transformer field testing
- Inverter phase rotation and matching with utility
- Relay settings/transfer trip/etc. at the point of interconnection to Owner
- Other Contractor-prescribed procedures

All QA/QC testing procedures onsite shall be witnessed and documented by a qualified representative of Contractor. Owner shall observe and witness QA/QC as necessary and at its discretion. A qualified field engineer/QA representative of Contractor shall date and sign documentation indicating completion and acceptance of each onsite QA/QC test procedures.

Following installation, Contractor shall provide a proposed commissioning and startup plan for the Plant.

Contractor shall coordinate with Owner to develop an acceptable commissioning plan that includes a checkout and startup procedure. This work will assure: that systems are activated in a manner that is safe for personnel as well as for the equipment, that Contractor work is complete and according to the contract documents, and that the systems perform as required by the contract documents and are ready to be turned over to Owner. As the construction and

installation of the systems nears completion, Contractor shall prepare punch lists and conduct system walk-downs, sub-system and system checkouts, startups, testing, and turnovers.

The final approved Commissioning Procedures shall, at minimum, include the following:

- Safety plan during startup and commissioning
- Review of all QA/QC testing on the DC and AC sides of inverters
- Detailed procedure for PV Plant startup, including switching sequencing
- Confirm testing and energizing inverters in conformance with manufacturer's recommended procedures; note operating voltages; and confirm inverter is performing as expected
- Under full sun conditions, and after at least 15 minutes of operation, taking and recording PV Plant operating data—such as but not limited to MWDC, MWAC, VDC, VAC, IDC, IAC, Solar Radiation, etc.
- Testing the system control and monitoring system to verify that it is performing correctly
- Testing the communication system for offsite monitoring
- Testing the Plant metering and protective relaying in conjunction with the utility during energization procedures
- Detailed procedure for interface and initialization with the grid
- Documentation of successful startup and commissioning procedure
- Written notification submitted by Contractor to Owner that the completion of Commissioning has occurred

Upon successful completion of energizing and startup, the Plant will be considered operable.

EXHIBIT F
Seller Authorization to Release Generation Data to PacifiCorp

See attached letter



Transmission Services
Attn: Vice President, Transmission Services
825 NE Multnomah, Suite 1600
Portland, OR 97232

RE: _____ **Interconnection Request**

Dear Sir:

Obsidian Renewables, LLC hereby voluntarily authorizes PacifiCorp's Transmission business unit to share Sprague River solar project's generator interconnection information and generator meter data with Marketing Affiliate employees of PacifiCorp Energy, including, but not limited to those in the Commercial and Trading group. Obsidian Renewables, LLC acknowledges that PacifiCorp did not provide it any preferences, either operational or rate-related, in exchange for this voluntary consent.



D. Todd Gregory

Vice President _____

7-7-14

Date

EXHIBIT G
SCHEDULE 37 and PRICING SUMMARY TABLE

Year	On-Peak ¢/kWh	Off-Peak ¢/kWh
2016	6.04	3.69
2017	6.32	3.91
2018	6.66	4.21
2019	6.99	4.50
2020	6.94	4.41
2021	7.23	4.65
2022	7.67	5.04
2023	7.92	5.24
2024	7.89	5.16
2025	8.09	5.32
2026	8.39	5.57
2027	8.66	5.78
2028	8.88	5.95
2029	9.07	6.09
2030	9.20	6.16
2031, up to but not including November 30, 2031	9.35	6.25
from November 30, 2031 through the Termination Date:	Price specified by Section 5.2 of the Agreement	

**AVOIDED COST PURCHASES FROM
QUALIFYING FACILITIES OF 10,000 KW OR LESS**

Page 1

Available

To owners of Qualifying Facilities making sales of electricity to the Company in the State of Oregon.

Applicable

For power purchased from Qualifying Facilities with a nameplate capacity of 10,000 kW or less or that, together with any other electric generating facility using the same motive force, owned or controlled by the same person(s) or affiliated person(s), and located at the same site, has a nameplate capacity of 10,000 kW or less. Owners of these Qualifying Facilities will be required to enter into a written power sales contract with the Company.

Definitions

Cogeneration Facility

A facility which produces electric energy together with steam or other form of useful energy (such as heat) which are used for industrial, commercial, heating or cooling purposes through the sequential use of energy.

Qualifying Facilities

Qualifying cogeneration facilities or qualifying small power production facilities within the meaning of section 201 and 210 of the Public Utility Regulatory Policies Act of 1978 (PURPA), 16 U.S.C. 796 and 824a-3.

Small Power Production Facility

A facility which produces electric energy using as a primary energy source biomass, waste, renewable resources or any combination thereof and has a power production capacity which, together with other facilities located at the same site, is not greater than 80 megawatts.

On-Peak Hours or Peak Hours

On-peak hours are defined as 6:00 a.m. to 10:00 p.m. Pacific Prevailing Time Monday through Saturday, excluding NERC holidays.

Due to the expansions of Daylight Saving Time (DST) as adopted under Section 110 of the U.S. Energy Policy Act of 2005, the time periods shown above will begin and end one hour later for the period between the second Sunday in March and the first Sunday in April and for the period between the last Sunday in October and the first Sunday in November.

Off-Peak Hours

All hours other than On-Peak.

West Side Gas Market Index

The monthly indexed gas price shall be the average of the price indexes published by Platts in "Inside FERC's Gas Market Report" monthly price report for Northwest Pipeline Corp. Rock Mountains, Northwest Pipeline Corp. Canadian Border, and Rockies/Northwest Stanfield, OR.

Excess Output

Excess output shall mean any increment of Net Output delivered at a rate, on an hourly basis, exceeding the Facility Nameplate Capacity. PacifiCorp shall pay Seller the Off-peak Price as described and calculated under pricing option 5 for all Excess Output.

(continued)

Same Site

Generating facilities are considered to be located at the same site as the QF for which qualification for the standard rates and standard contract is sought if they are located within a five-mile radius of any generating facilities or equipment providing fuel or motive force associated with the QF for which qualification for the standard rates and standard contract is sought.

Person(s) or Affiliated Person(s)

A natural person or persons or any legal entity or entities sharing common ownership, management or acting jointly or in concert with or exercising influence over the policies or actions of another person or entity. Two facilities will not be held to be owned or controlled by the same person(s) or affiliated person(s) solely because they are developed by a single entity. Two facilities will not be held to be owned or controlled by the same person(s) or affiliated person(s) if such common person or persons is a "passive investor" whose ownership interest in the QF is primarily related to utilizing production tax credits, green tag values and MACRS depreciation as the primary ownership benefit. A unit of Oregon local government may also be a "passive investor" if the local governmental unit demonstrates that it will not have an equity ownership interest in or exercise any control over the management of the QF and that its only interest is a share of the cash flow from the QF, which share will not exceed 20%. The 20% cash flow share limit may only be exceeded for good cause shown and only with the prior approval of the Commission.

Shared Interconnection and Infrastructure

QFs otherwise meeting the separate ownership test and thereby qualified for entitlement to the standard rates and standard contract will not be disqualified by utilizing an interconnection or other infrastructure not providing motive force or fuel that is shared with other QFs qualifying for the standard rates and standard contract so long as the use of the shared interconnection complies with the interconnecting utility's safety and reliability standards, interconnection contract requirements and Prudent Electrical Practices as that term is defined in the interconnecting utility's approved standard contract.

Dispute Resolution

Upon request, the QF will provide the purchasing utility with documentation verifying the ownership, management and financial structure of the QF in reasonably sufficient detail to allow the utility to make an initial determination of whether or not the QF meets the above-described criteria for entitlement to the standard rates and standard contract. Any dispute concerning a QF's entitlement to the standard rates and standard contract shall be presented to the Commission for resolution.

Self Supply Option

Owner shall elect to sell all Net Output to PacifiCorp and purchase its full electric requirements from PacifiCorp or sell Net Output surplus to its needs at the Facility site to PacifiCorp and purchase partial electric requirements service from PacifiCorp, in accordance with the terms and conditions of the power purchase agreement and the appropriate retail service.

(continued)

Pricing Options**1. Fixed Avoided Cost Prices**

Prices are fixed at the time that the contract is signed by both the Qualifying Facility and the Company and will not change during the term of the contract. Fixed Avoided Cost Prices are available for a contract term of up to 15 years and prices under a longer term contract (up to 20 years) will thereafter be under either the Firm Market Indexed, the Banded Gas Market Indexed or the Gas Market Indexed Avoided Cost pricing option.

2. Gas Market Indexed Avoided Cost Prices

Fixed prices apply during the resource sufficiency period (2012 through 2015), thereafter a portion of avoided cost prices are indexed to actual monthly West Side Gas Market Index prices. The remaining portion of avoided cost prices will be fixed at the time that the contract is signed by both the Qualifying Facility and the Company and will not change during the term of the contract. Prices are available for a term of up to 20 years.

3. Banded Gas Market Indexed Avoided Cost Prices

Fixed prices apply during the resource sufficiency period (2012 through 2015), thereafter a portion of avoided cost prices are indexed to actual monthly West Side Gas Market Index prices. The remaining portion of avoided cost prices will be fixed at the time that the contract is signed by both the Qualifying Facility and the Company and will not change during the term of the contract. The gas indexed portion of the avoided cost prices are banded to limit the amount that prices can vary with changes in gas prices. Prices are available for a term of up to 20 years.

4. Firm Market Indexed Avoided Cost Prices

Firm market index avoided cost prices are available to Qualifying Facilities that contract to deliver firm power. Monthly on-peak / off-peak prices paid are a blending of Intercontinental Exchange (ICE) Day Ahead Power Price Report at market hubs for on-peak and off-peak prices. The monthly blending matrix is available upon request.

5. Non-firm Market Index Avoided Cost Prices

Non- Firm market index avoided cost prices are available to Qualifying Facilities that do not elect to provide firm power. Qualifying Facilities taking this option will have contracts that do not include minimum delivery requirements, default damages for construction delay, for under delivery or early termination, or default security for these purposes. Monthly On-Peak / Off-Peak prices paid are a blending of ICE Day Ahead Power Price Report at market hubs for on-peak and off-peak prices. The monthly blending matrix is available upon request.

(continued)

Monthly Payments

A Qualifying Facility shall select the option of payment at the time of signing the contract under one of three Pricing Options as specified above. Once an option is selected the option will remain in effect for the duration of the Facility's contract.

Fixed Avoided Cost Prices

In accordance with the terms of a contract with a Qualifying Facility, the Company shall pay for all separately metered kilowatt-hours of On-Peak and Off-Peak generation at the fixed prices as provided in this tariff. The definition of On-Peak and Off-Peak is as defined in the definitions section of this tariff.

Gas Market Indexed Avoided Cost Prices

In accordance with the terms of a contract with a Qualifying Facility, the Company shall pay for all separately metered kilowatt-hours of On-Peak and Off-Peak generation at On-Peak and Off-Peak prices calculated each month.

To calculate the Off-Peak price, multiply the West Side Gas Market Index price in \$/MMBtu by 0.696 to get actual gas price in cents/kWh. The Off-Peak Energy Adder is added to the actual gas price to get the Off-Peak Price.

The On-Peak price is the Off-Peak price plus the On-Peak Capacity Adder.

Banded Gas Indexed Avoided Cost Prices

In accordance with the terms of a contract with a Qualifying Facility, the Company shall pay for all separately metered kilowatt-hours of On-Peak and Off-Peak generation at On-Peak and Off-Peak prices calculated each month.

To calculate the Off-Peak price, multiply the West Side Gas Market Index price in \$/MMBtu by 0.696 to get actual gas price in cents/kWh. This price is banded such that the actual gas price shall be no lower than the Gas Market Index Floor nor greater than the Gas Market Index Ceiling as listed in the price section of this tariff. The Off-Peak Energy Adder is added to the actual gas price to get the Off-Peak Price.

The On-Peak price is the Off-Peak price plus the On-Peak Capacity Adder.

Firm Market Indexed and Non-firm Market Index Avoided Cost Prices

In accordance with the terms of a contract with a Qualifying Facility, the Company shall pay for all separately metered kilowatt-hours of On-Peak and Off-Peak generation at the market prices calculated at the time of delivery. The definition of On-Peak and Off-Peak is as defined in the definitions section of this tariff.

(continued)

**AVOIDED COST PURCHASES FROM
 QUALIFYING FACILITIES OF 10,000 KW OR LESS**
Avoided Cost Prices
Pricing Option 1 – Fixed Avoided cost Prices ¢/kWh

Deliveries During Calendar Year	On-Peak Energy Price	Off-Peak Energy Price
	(a)	(b)
2012	3.09	2.32
2013	3.72	2.62
2014	4.13	2.80
2015	4.39	2.99
2016	6.04	3.69
2017	6.32	3.91
2018	6.66	4.21
2019	6.99	4.50
2020	6.94	4.41
2021	7.23	4.65
2022	7.67	5.04
2023	7.92	5.24
2024	7.89	5.16
2025	8.09	5.32
2026	8.39	5.57
2027	8.66	5.78
2028	8.88	5.95
2029	9.07	6.09
2030	9.20	6.16

(continued)

**AVOIDED COST PURCHASES FROM
QUALIFYING FACILITIES OF 10,000 KW OR LESS**
Avoided Cost Prices (Continued)
Pricing Option 2 – Gas Market Indexed Avoided Cost Prices ¢/kWh

Deliveries During Calendar Year	Fixed Prices		Gas Market Index		Forecast West Side Gas Market Index Price (2) \$/MMBtu	Estimated Prices (3)	
	On-Peak Energy Price (a)	Off-Peak Energy Price (b)	On-Peak Capacity Adder (1) (c) Avoided Firm Capacity Costs / (0.876 * 88.6% * 57%)	Off-Peak Energy Adder (d) Total Avoided Energy Costs - ((e) * 0.696)		On- Peak Energy Price (f) (g) + (c)	Off-Peak Energy Price (g) ((e) * 0.696) + (d)
2012	3.09	2.32					
2013	3.72	2.62	Market Based Prices				
2014	4.13	2.80	2012 through 2015				
2015	4.39	2.99					
2016			2.36	0.44	\$4.66	6.042	3.685
2017			2.40	0.47	\$4.95	6.316	3.914
2018			2.45	0.47	\$5.38	6.660	4.212
2019			2.49	0.47	\$5.79	6.988	4.496
2020			2.53	0.47	\$5.66	6.943	4.409
2021			2.58	0.48	\$5.98	7.225	4.645
2022			2.63	0.50	\$6.53	7.667	5.041
2023			2.67	0.52	\$6.78	7.916	5.242
2024			2.72	0.53	\$6.66	7.885	5.163
2025			2.77	0.54	\$6.87	8.093	5.322
2026			2.82	0.55	\$7.21	8.385	5.565
2027			2.87	0.57	\$7.49	8.655	5.781
2028			2.93	0.60	\$7.69	8.877	5.948
2029			2.98	0.62	\$7.85	9.070	6.086
2030			3.04	0.64	\$7.92	9.197	6.156
2031			3.10	0.64	\$8.06	9.348	6.246
2032			3.16	0.65	\$8.21	9.526	6.365
2033			3.22	0.66	\$8.37	9.705	6.484
2034			3.29	0.68	\$8.53	9.902	6.616

(1) Avoided Firm Capacity Costs are equal to the fixed costs of a SCCT as identified in the Company's 2011 IRP.

(2) A heat rate of 0.696 is used to adjust gas prices from \$/MMBtu to ¢/kWh

(3) Estimated avoided cost prices based upon forecast West Side Gas Market Index prices.
Actual prices will be calculated each month using actual index gas prices.

(continued)

**AVOIDED COST PURCHASES FROM
 QUALIFYING FACILITIES OF 10,000 KW OR LESS**
Avoided Cost Prices (Continued)
Pricing Option 3 – Banded Gas Market Indexed Avoided Cost Prices $\$/kWh$

Deliveries During Calendar Year	Fixed Prices		Banded Gas Market Index				Forecast West Side Gas Market Index Price (2) \$/MMBtu	Estimated Prices (3)	
	On-Peak Energy Price	Off-Peak Energy Price	On-Peak Capacity Adder (1)	Off-Peak Energy Adder	Gas Market Index			On-Peak Energy Price	Off-Peak Energy Price
					Floor	Ceiling			
	(a)	(b)	(c)	(d)	(e)	(f)		(g)	(h)
			Avoided Firm Capacity Costs / (0.876 * 88.6% * 57%)	Total Avoided Energy Costs - ((e) * 0.696)	(g) * 0.696 * 90%	(g) * 0.696 * 110%		(i) + (c)	MIN(MAX((g) * 0.696), (e)), (f) + (d)
2012	3.09	2.32							
2013	3.72	2.62							
2014	4.13	2.80							
2015	4.39	2.99							
			Market Based Prices 2010 through 2013						
2016			2.36	0.44	2.92	3.57	\$4.66	6.04	3.69
2017			2.40	0.47	3.10	3.79	\$4.95	6.32	3.91
2018			2.45	0.47	3.37	4.12	\$5.38	6.66	4.21
2019			2.49	0.47	3.63	4.43	\$5.79	6.99	4.50
2020			2.53	0.47	3.55	4.33	\$5.66	6.94	4.41
2021			2.58	0.48	3.75	4.58	\$5.98	7.23	4.65
2022			2.63	0.50	4.09	5.00	\$6.53	7.67	5.04
2023			2.67	0.52	4.25	5.19	\$6.78	7.92	5.24
2024			2.72	0.53	4.17	5.10	\$6.66	7.89	5.16
2025			2.77	0.54	4.30	5.26	\$6.87	8.09	5.32
2026			2.82	0.55	4.52	5.52	\$7.21	8.39	5.57
2027			2.87	0.57	4.69	5.73	\$7.49	8.66	5.78
2028			2.93	0.60	4.82	5.89	\$7.69	8.88	5.95
2029			2.98	0.62	4.92	6.01	\$7.85	9.07	6.09
2030			3.04	0.64	4.96	6.06	\$7.92	9.20	6.16
2031			3.10	0.64	5.05	6.17	\$8.06	9.35	6.25
2032			3.16	0.65	5.14	6.29	\$8.21	9.53	6.37
2033			3.22	0.66	5.24	6.41	\$8.37	9.71	6.48
2034			3.29	0.68	5.34	6.53	\$8.53	9.90	6.62

- (1) Avoided Firm Capacity Costs are equal to the fixed costs of a SCCT as identified in the Company's 2011 IRP.
 (2) A heat rate of 0.696 is used to adjust gas prices from \$/MMBtu to $\$/kWh$
 (3) Estimated avoided cost prices based upon forecast West Side Gas Market Index prices.
 Actual prices will be calculated each month using actual index gas prices.

(continued)

Example of Gas Pricing Options available to the Qualifying Facility

An example of the two gas pricing options using different assumed gas prices is provided at the end of this tariff.

Qualifying Facilities Contracting Procedure

Interconnection and power purchase agreements are handled by different functions within the Company. Interconnection agreements (both transmission and distribution level voltages) are handled by the Company's transmission function (PacifiCorp Transmission Services) while power purchase agreements are handled by the Company's merchant function (PacifiCorp Commercial and Trading).

It is recommended that the owner initiate its request for interconnection 18 months ahead of the anticipated in-service date to allow time for studies, negotiation of agreements, engineering, procurement, and construction of the required interconnection facilities. Early application for interconnection will help ensure that necessary interconnection arrangements proceed in a timely manner on a parallel track with negotiation of the power purchase agreement.

1. Qualifying Facilities up to 10,000 kW

APPLICATION: To owners of existing or proposed QFs with a design capacity less than or equal to 10,000 kW who desire to make sales to the Company in the state of Oregon. Such owners will be required to enter into a written power purchase agreement with the Company pursuant to the procedures set forth below.

I. Process for Completing a Power Purchase Agreement**A. Communications**

Unless otherwise directed by the Company, all communications to the Company regarding QF power purchase agreements should be directed in writing as follows:

PacifiCorp
Manager-QF Contracts
825 NE Multnomah St, Suite 600
Portland, Oregon 97232

The Company will respond to all such communications in a timely manner. If the Company is unable to respond on the basis of incomplete or missing information from the QF owner, the Company shall indicate what additional information is required. Thereafter, the Company will respond in a timely manner following receipt of all required information.

(continued)

B. Procedures

1. The Company's approved generic or standard form power purchase agreements may be obtained from the Company's website at www.pacificorp.com, or if the owner is unable to obtain it from the website, the Company will send a copy within seven days of a written request.
2. In order to obtain a project specific draft power purchase agreement the owner must provide in writing to the Company, general project information required for the completion of a power purchase agreement, including, but not limited to:
 - (a) demonstration of ability to obtain QF status;
 - (b) design capacity (MW), station service requirements, and net amount of power to be delivered to the Company's electric system;
 - (c) generation technology and other related technology applicable to the site;
 - (d) proposed site location;
 - (e) schedule of monthly power deliveries;
 - (f) calculation or determination of minimum and maximum annual deliveries;
 - (g) motive force or fuel plan;
 - (h) proposed on-line date and other significant dates required to complete the milestones;
 - (i) proposed contract term and pricing provisions (i.e., fixed, deadband, gas indexed);
 - (j) status of interconnection or transmission arrangements;
 - (k) point of delivery or interconnection;
3. The Company shall provide a draft power purchase agreement when all information described in Paragraph 2 above has been received in writing from the QF owner. Within 15 business days following receipt of all information required in Paragraph 2, the Company will provide the owner with a draft power purchase agreement including current standard avoided cost prices and/or other optional pricing mechanisms as approved by the Oregon Public Utilities Commission in this Schedule 37.
4. If the owner desires to proceed with the power purchase agreement after reviewing the Company's draft power purchase agreement, it may request in writing that the Company prepare a final draft power purchase agreement. In connection with such request, the owner must provide the Company with any additional or clarified project information that the Company reasonably determines to be necessary for the preparation of a final draft power purchase agreement. Within 15 business days following receipt of all information requested by the Company in this paragraph 4, the Company will provide the owner with a final draft power purchase agreement.

(continued)

B. Procedures (continued)

- 5 After reviewing the final draft power purchase agreement, the owner may either prepare another set of written comments and proposals or approve the final draft power purchase agreement. If the owner prepares written comments and proposals the Company will respond in 15 business days to those comments and proposals.
6. When both parties are in full agreement as to all terms and conditions of the draft power purchase agreement, the Company will prepare and forward to the owner within 15 business days, a final executable version of the agreement. Following the Company's execution a completely executed copy will be returned to the owner. Prices and other terms and conditions in the power purchase agreement will not be final and binding until the power purchase agreement has been executed by both parties.

II. Process for Negotiating Interconnection Agreements

[NOTE: Section II applies only to QFs connecting directly to PacifiCorp's electrical system. An off-system QF should contact its local utility or transmission provider to determine the interconnection requirements and wheeling arrangement necessary to move the power to PacifiCorp's system.]

In addition to negotiating a power purchase agreement, QFs intending to make sales to the Company are also required to enter into an interconnection agreement that governs the physical interconnection of the project to the Company's transmission or distribution system. The Company's obligation to make purchases from a QF is conditioned upon the QF completing all necessary interconnection arrangements. It is recommended that the owner initiate its request for interconnection 18 months ahead of the anticipated in-service date to help ensure that necessary interconnection arrangements proceed in a timely manner on a parallel track with negotiation of the power purchase agreement.

Because of functional separation requirements mandated by the Federal Energy Regulatory Commission, interconnection and power purchase agreements are handled by different functions within the Company. Interconnection agreements (both transmission and distribution level voltages) are handled by the Company's transmission function (including but not limited to PacifiCorp Transmission Services) while power purchase agreements are handled by the Company's merchant function (including but not limited to PacifiCorp's Commercial and Trading Group).

(continued)

II. Process for Negotiating Interconnection Agreements (continued)

A. Communications

Initial communications regarding interconnection agreements should be directed to the Company in writing as follows:

PacifiCorp
Director – Transmission Services
825 NE Multnomah St, Suite 1600
Portland, Oregon 97232

Based on the project size and other characteristics, the Company will direct the QF owner to the appropriate individual within the Company's transmission function who will be responsible for negotiating the interconnection agreement with the QF owner. Thereafter, the QF owner should direct all communications regarding interconnection agreements to the designated individual, with a copy of any written communications to the address set forth above.

B. Procedures

Generally, the interconnection process involves (1) initiating a request for interconnection, (2) undertaking studies to determine the system impacts associated with the interconnection and the design, cost, and schedules for constructing any necessary interconnection facilities, and (3) executing an interconnection agreement to address facility construction, testing, acceptance, ownership, operation and maintenance issues. Consistent with PURPA and Oregon Public Utility Commission regulations, the owner is responsible for all interconnection costs assessed by the Company on a nondiscriminatory basis. For interconnections impacting the Company's Transmission and Distribution System, the Company will process the interconnection application through PacifiCorp Transmission Services.

(continued)

Example of Gas Pricing Options given Assumed Gas Prices ¢/kWh
Banded Gas Market Index

Year	Prices Listed in the Tariff				Example using assumed Gas Prices						Compared to Fixed Prices	
	On-Peak Capacity Adder	Off-Peak Energy Adder	Gas Market Index		Assumed Gas Price \$/MMBtu	Fuel Index			Price Paid to QF		Off-Peak Price	On-Peak Price
			Floor 90%	Ceiling 110%		Actual Energy Price	Floor / Ceiling Component	Type of Price	Off-Peak Price	On-Peak Price		
(a)	(b)	(c)	(d)	(e)	(f)	(g)	(h)	(i)	(j)	(k)	(l)	
					(e) x 0.696				(b) + (g)	(a) + (i)		
2016	2.36	0.44	2.92	3.57	\$2.00	1.39	2.92	Floor	3.36	5.72		
					\$4.00	2.78	2.92	Floor	3.36	5.72		
					\$5.00	3.48	3.48	Actual	3.92	6.28	3.69	6.04
					\$7.00	4.87	3.57	Ceiling	4.01	6.37		
					\$10.00	6.96	3.57	Ceiling	4.01	6.37		

Gas Market Method

Year	Prices Listed in the Tariff				Example using assumed Gas Prices						Compared to Fixed Prices	
	On-Peak Capacity Adder	Off-Peak Energy Adder	Fuel Index		Assumed Gas Price \$/MMBtu	Fuel Index			Price Paid to QF		Off-Peak Price	On-Peak Price
			Floor 90%	Ceiling 110%		Actual Energy Price	Floor / Ceiling Component	Type of Price	Off-Peak Price	On-Peak Price		
(a)	(b)	(c)	(d)	(e)	(f)	(g)	(h)	(i)	(j)	(k)	(l)	
					(e) x 0.696				(b) + (i)	(a) + (j)		
2016	2.36	0.44	Not Relevant		\$2.00	1.39			1.83	4.19		
					\$4.00	2.78			3.22	5.58		
					\$5.00	3.48	Not Relevant		3.92	6.28	3.69	6.04
					\$7.00	4.87			5.31	7.67		
					\$10.00	6.96			7.40	9.76		

ADDENDUM A
Jury Trial Waiver

PacifiCorp and Obsidian Renewables, LLC ("Obsidian") are parties to that certain Power Purchase Agreement executed the date last written below (the "PPA"). This Addendum A to the PPA is entered into by and between PacifiCorp and Obsidian and is intended to be interpreted and applied to the PPA.

Whereas, the Parties for their respective business purposes have an interest in not presenting a dispute to a jury for trial should a dispute arise between the Parties;

NOW, THEREFORE, for independent consideration, the receipt and sufficiency of which is acknowledged by both Parties, the Parties do hereby declare and agree as follows:

TO THE FULLEST EXTENT PERMITTED BY LAW, EACH OF THE PARTIES HERETO WAIVES ANY RIGHT IT MAY HAVE TO A TRIAL BY JURY IN RESPECT OF LITIGATION DIRECTLY OR INDIRECTLY ARISING OUT OF, UNDER OR IN CONNECTION WITH THIS AGREEMENT. EACH PARTY FURTHER WAIVES ANY RIGHT TO CONSOLIDATE ANY ACTION IN WHICH A JURY TRIAL HAS BEEN WAIVED WITH ANY OTHER ACTION IN WHICH A JURY TRIAL CANNOT BE OR HAS NOT BEEN WAIVED.

This Addendum A to the PPA is executed and made effective this 30th day of July, 2014.

PacifiCorp

By: _____

Name: Bruce Griswold

Title: Director, Short-Term Origination
and QF Contracts

BWS 7-25-2014

Obsidian Renewables, LLC

By: _____

Name: David W. Brown

Title: Senior Principal