



e-FILING REPORT COVER SHEET

COMPANY NAME: PORTLAND GENERAL ELECTRIC COMPANY

DOES REPORT CONTAIN CONFIDENTIAL INFORMATION? No Yes If yes, submit a redacted public version (or a cover letter) by email. Submit the confidential information as directed in OAR 860-001-0070 or the terms of an applicable protective order.

Select report type: RE (Electric) RG (Gas) RW (Water) RT (Telecommunications)
 RO (Other, for example, industry safety information)

Did you previously file a similar report? No Yes, report docket number: RE-143

Report is required by: OAR 860-029-0020

Statute

Order

Note: A one-time submission required by an order is a compliance filing and not a report (file compliance in the applicable docket)

Other

(For example, federal regulations, or requested by Staff)

Is this report associated with a specific docket/case? No Yes, docket number: RE-143

List Key Words for this report. We use these to improve search results.

Qualifying Facility, Power Purchase Agreement, PPA, PURPA

Send the completed Cover Sheet and the Report in an email addressed to PUC.FilingCenter@state.or.us

Send confidential information, voluminous reports, or energy utility Results of Operations Reports to PUC Filing Center, PO Box 1088, Salem, OR 97308-1088 or by delivery service to 201 High Street SE Suite 100, Salem, OR 97301.



Portland General Electric Company
121 SW Salmon Street • Portland, Oregon 97204
PortlandGeneral.com

July 2, 2018

Public Utility Commission of Oregon
Attn: Filing Center
201 High Street, S.E.
P.O. Box 1088
Salem, OR 97308-1088

**RE: RE 143 – Portland General Electric Company Informational Filing of
Qualifying Facility (QF) Agreement**

Pursuant to Oregon Administrative Rule 860-029-0020(1), Portland General Electric Company submits for filing in OPUC Docket No. RE-143:

Walker Creek Solar LLC, executed qualifying facility (QF)
Power Purchase Agreement (PPA)

Should you have any questions or comments regarding this filing, please contact Mary Widman at (503) 464-8223. Please direct all formal correspondence and requests to the following email address pge.opuc.filings@pgn.com

Sincerely,

A handwritten signature in blue ink, appearing to read "Karla Wenzel". The signature is fluid and cursive, written in a professional style.

Karla Wenzel
Manager, Pricing and Tariffs

Enclosure

STANDARD RENEWABLE IN-SYSTEM VARIABLE POWER PURCHASE

AGREEMENT

THIS AGREEMENT is between Walker Creek Solar, LLC ("Seller") and Portland General Electric Company ("PGE") (hereinafter each a "Party" or collectively, "Parties") and is effective upon execution by both Parties ("Effective Date").

RECITALS

Seller intends to construct, own, operate and maintain a Solar facility for the generation of electric power located in Polk (at GPS 45.021, -123.095) County, Oregon with a Nameplate Capacity Rating of 2,500 kilowatt ("kW"), as further described in Exhibit A ("Facility"); and

Seller intends to operate the Facility as a "Qualifying Facility," as such term is defined in Section 3.1.3, below.

Seller shall sell and PGE shall purchase the entire Net Output, as such term is defined in Section 1.21, below, from the Facility in accordance with the terms and conditions of this Agreement.

AGREEMENT

NOW, THEREFORE, the Parties mutually agree as follows:

SECTION 1: DEFINITIONS

When used in this Agreement, the following terms shall have the following meanings:

1.1. "As-built Supplement" means the supplement to Exhibit A provided by Seller in accordance with Section 4.3 following completion of construction of the Facility, describing the Facility as actually built.

1.2. "Base Hours" is defined as the total number of hours in each Contract Year (8,760 or 8,784 for leap year).

1.3. "Billing Period" means a period between PGE's readings of its power purchase billing meter at the Facility in the normal course of PGE's business. Such periods may vary and may not coincide with calendar months; however, PGE shall use best efforts to read the power purchase billing meter in 12 equally spaced periods per year.

1.4. "Cash Escrow" means an agreement by two parties to place money into the custody of a third party for delivery to a grantee only after the fulfillment of the conditions specified.

1.5. "Commercial Operation Date" means the date that the Facility is deemed by PGE to be fully operational and reliable. PGE may, at its discretion, require, among other things, that all of the following events have occurred:

1.5.1. (facilities with nameplate under 500 kW exempt from following requirement) PGE has received a certificate addressed to PGE from a Licensed Professional Engineer ("LPE") acceptable to PGE in its reasonable judgment stating that the Facility is able to generate electric power reliably in accordance with the terms and conditions of this Agreement (certifications required under this Section 1.5 can be provided by one or more LPEs);

1.5.2. Start-Up Testing of the Facility has been completed in accordance with Section 1.36;

1.5.3. (facilities with nameplate under 500 kW exempt from following requirement) After PGE has received notice of completion of Start-Up Testing, PGE has received a certificate addressed to PGE from an LPE stating that the Facility has operated for testing purposes under this Agreement and was continuously mechanically available for operation for a minimum of 120 hours. The Facility must provide ten (10) working days written notice to PGE prior to the start of the initial testing period. If the mechanical availability of the Facility is interrupted during this initial testing period or any subsequent testing period, the Facility shall promptly start a new Test Period and provide PGE forty-eight (48) hours written notice prior to the start of such testing period;

1.5.4. (facilities with nameplate under 500 kW exempt from following requirement) PGE has received a certificate addressed to PGE from an LPE stating that in accordance with the Generation Interconnection Agreement, all required interconnection facilities have been constructed all required interconnection tests have been completed; and the Facility is physically interconnected with PGE's electric system.

1.5.5. (facilities with nameplate under 500kW exempt from following requirement) PGE has received a certificate addressed to PGE from an LPE stating that Seller has obtained all Required Facility Documents and, if requested by PGE in writing, has provided copies of any or all such requested Required Facility Documents;

1.6. "Contract Price" means the applicable price, including on-peak and off-peak prices, as specified in the Schedule.

1.7. "Contract Year" means each twelve (12) month period commencing upon the Commercial Operation Date or its anniversary during the Term, except the final contract year will be the period from the last anniversary of the Commercial Operation Date during the Term until the end of the Term.

1.8. "Effective Date" has the meaning set forth in Section 2.1.

1.9. "Environmental Attributes" shall mean any and all claims, credits, benefits, emissions reductions, offsets, and allowances, howsoever entitled, resulting from the avoidance of the emission of any gas, chemical or other substance to the air, soil or water. Environmental Attributes include but are not limited to: (1) any avoided emissions of pollutants to the air, soil or water such as (subject to the foregoing) sulfur oxides (SOx), nitrogen oxides (NOx), carbon monoxide (CO), and other pollutants; and (2) any avoided emissions of carbon dioxide (CO₂), methane (CH₄), and other greenhouse gasses (GHGs) that have been determined by the United Nations

Intergovernmental Panel on Climate Change to contribute to the actual or potential threat of altering the Earth's climate by trapping heat in the atmosphere.

1.10. "Facility" has the meaning set forth in the Recitals.

1.11. "Generation Interconnection Agreement" means the generation interconnection agreement to be entered into separately between Seller and PGE, providing for the construction, operation, and maintenance of interconnection facilities required to accommodate deliveries of Seller's Net Output.

1.12. "Generation Unit" means each separate electrical generator that contributes towards Nameplate Capacity Rating included in Exhibit A. For solar facilities, a generating unit is a complete solar electrical generation system within the Facility that is able to generate and deliver energy to the Point of Delivery independent of other Generation Units within the same Facility.

1.13. "Letter of Credit" means an engagement by a bank or other person made at the request of a customer that the issuer will honor drafts or other demands for payment upon compliance with the conditions specified in the letter of credit.

1.14. "Licensed Professional Engineer" or "LPE" means a person who is licensed to practice engineering in the state where the Facility is located, who has no economic relationship, association, or nexus with the Seller, and who is not a representative of a consulting engineer, contractor, designer or other individual involved in the development of the Facility, or of a manufacturer or supplier of any equipment installed in the Facility. Such Licensed Professional Engineer shall be licensed in an appropriate engineering discipline for the required certification being made and be acceptable to PGE in its reasonable judgment.

1.15. "Lost Energy" means ((the Guarantee of Mechanical Availability as set forth in 3.1.10 / MAP) X Net Output for a Calendar Year) – Net Output for the Calendar Year. Lost Energy shall be zero unless the result of the calculation in this subsection results in a positive number.

1.16. "Lost Energy Value" means Lost Energy X the excess of the annual time-weighted average Mid-C Index Price for On-Peak and Off-Peak Hours over the time-weighted average Contract Price for On-Peak and Off-Peak Hours for the corresponding time period (provided that such excess shall not exceed the Contract Price and further provided that Lost Energy is deemed to be zero prior to reaching the Commercial Operation Date) plus any reasonable costs incurred by PGE to purchase replacement power and/or transmission to deliver the replacement power to the Point of Delivery. (For Start-Up Lost Energy Value see Section 1.35).

1.17. "Mechanical Availability Percentage" or "MAP" shall mean that percentage for any Contract Year for the Facility calculated in accordance with the following formula:

$$\text{MAP} = 100 \times (\text{Operational Hours}) / (\text{Base Hours} \times \text{Number of Units})$$

1.18. "Mid-C Index Price" means the Day Ahead Intercontinental Exchange ("ICE") index price for the bilateral OTC market for energy at the Mid-C Physical for

Average On Peak Power and Average Off Peak Power found on the following website: <https://www.theice.com/products/OTC/Physical-Energy/Electricity>. In the event ICE no longer publishes this index, PGE and the Seller agree to select an alternative successor index representative of the Mid-C trading hub.

1.19. "Nameplate Capacity Rating" means the maximum capacity of the Facility as stated by the manufacturer, expressed in kW, which shall not exceed 10,000 kW.

1.20. "Net Dependable Capacity" means the maximum capacity the Facility can sustain over a specified period modified for seasonal limitations, if any, and reduced by the capacity required for station service or auxiliaries.

1.21. "Net Output" means all energy expressed in kWhs produced by the Facility, less station and other onsite use and less transformation and transmission losses. Net Output does not include any environmental attributes.

1.22. "Number of Units" means the number of Generating Units in the Facility described in Exhibit A.

1.23. "Off-Peak Hours" has the meaning provided in the Schedule.

1.24. "On-Peak Hours" has the meaning provided in the Schedule.

1.25. "Operational Hours" for the Facility means the total across all Generating Units of the number of hours each of the Facility's Generating Units are potentially capable of producing power at its Nameplate Capacity Rating regardless of actual weather, season and time of day or night, without any mechanical operating constraint or restriction, and potentially capable of delivering such power to the Point of Delivery in a Contract Year. During up to, but not more than, 200 hours of Planned Maintenance during a Contract Year for each Generation Unit and hours during which an event of Force Majeure exists, a Generation Unit shall be considered potentially capable of delivering such power to the Point of Delivery. For example, in the absence of any Planned Maintenance beyond 200 hours on any Generation Unit of Event of Force Majeure, the Operational Hours for a wind farm with five separate two MW turbines would be 43,800 for a Contract Year.

1.26. "Planned Maintenance" means outages scheduled 90 days in advance, with PGE's prior written consent, which shall not be unreasonably withheld.

1.27. "Point of Delivery" means the high side of the generation step up transformer(s) located at the point of interconnection between the Facility and PGE's distribution or transmission system, as specified in the Generation Interconnection Agreement.

1.28. "Pre-Commercial Operation Date Minimum Net Output" shall mean, unless such MWh is specifically set forth by Seller in Exhibit A, an amount in MWh equal to seventy-five percent (75%) of the Nameplate Capacity Rating X thirty percent (30%) for a wind or other renewable QF or fifty percent (50%) for a solar QF X (whole months since the date selected in Section 2.2.1 / 12) X (8760 hours – 200 hours (assumed Planned Maintenance)) for each month. If Seller has provided specific expected monthly Net Output amounts for the Facility in Exhibit A, "Pre-Commercial Operation

Date Minimum Net Output” shall mean seventy-five (75%) X expected Net Output set forth in Exhibit A for each month.

1.29. “Prime Rate” means the publicly announced prime rate or reference rate for commercial loans to large businesses with the highest credit rating in the United States in effect from time to time quoted by Citibank, N.A. If a Citibank, N.A. prime rate is not available, the applicable Prime Rate shall be the announced prime rate or reference rate for commercial loans in effect from time to time quoted by a bank with \$10 billion or more in assets in New York City, N.Y., selected by the Party to whom interest based on the prime rate is being paid.

1.30. "Prudent Electrical Practices" means those practices, methods, standards and acts engaged in or approved by a significant portion of the electric power industry in the Western Electricity Coordinating Council that at the relevant time period, in the exercise of reasonable judgment in light of the facts known or that should reasonably have been known at the time a decision was made, would have been expected to accomplish the desired result in a manner consistent with good business practices, reliability, economy, safety and expedition, and which practices, methods, standards and acts reflect due regard for operation and maintenance standards recommended by applicable equipment suppliers and manufacturers, operational limits, and all applicable laws and regulations. Prudent Electrical Practices are not intended to be limited to the optimum practice, method, standard or act to the exclusion of all others, but rather to those practices, methods and acts generally acceptable or approved by a significant portion of the electric power generation industry in the relevant region, during the relevant period, as described in the immediate preceding sentence.

1.31. "Required Facility Documents" means all licenses, permits, authorizations, and agreements necessary for construction, operation, interconnection, and maintenance of the Facility including without limitation those set forth in Exhibit B.

1.32. “RPS Attributes” means all attributes related to the Net Output generated by the Facility that are required in order to provide PGE with “qualifying electricity,” as that term is defined in Oregon’s Renewable Portfolio Standard Act, Ore. Rev. Stat. 469A.010, in effect at the time of execution of this Agreement. RPS Attributes do not include Environmental Attributes that are greenhouse gas offsets from methane capture not associated with the generation of electricity and not needed to ensure that there are zero net emissions associated with the generation of electricity.

1.33. Schedule” shall mean PGE Schedule 201 filed with the Oregon Public Utilities Commission (“Commission”) in effect on the Effective Date of this Agreement and attached hereto as Exhibit D, the terms of which are hereby incorporated by reference.

1.34. Senior Lien” means a prior lien which has precedence as to the property under the lien over another lien or encumbrance.

1.35. “Start-Up Lost Energy Value” means for the period after the date specified in Section 2.2.2 but prior to achievement of the Commercial Operation Date: zero, unless the Net Output is less than the pro-rated Pre-Commercial Operation Date Minimum Net Output for the applicable delay period, and the time-weighted average of

the delay period's Mid-C Index Price for On-Peak Hours and Off-Peak Hours is greater than the time-weighted average of the delay period's Contract Price for On-Peak Hours and Off-Peak Hours, in which case Startup Lost Energy Value equals: (pro-rated Pre-Commercial Operation Date Minimum Net Output for the applicable period - Net Output for the applicable period) X (the lower of: the time-weighted average of the Contract Price for On-Peak hours and Off-Peak Hours during the applicable period; or (the time-weighted average of the Mid-C Index Price for On-Peak Hours and Off-Peak Hours during the applicable period – the time-weighted average of the Contract Price for On-Peak Hours and Off-Peak Hours during the applicable period)). The time-weighted average in this section will reflect the relative proportions of On-Peak Hours and Off-Peak Hours in each day.

1.36. "Start-Up Testing" means the completion of applicable required factory and start-up tests as set forth in Exhibit C.

1.37. "Step-in Rights" means the right of one party to assume an intervening position to satisfy all terms of an agreement in the event the other party fails to perform its obligations under the agreement.

1.38. "Term" shall mean the period beginning on the Effective Date and ending on the Termination Date.

1.39. "Test Period" shall mean a period of sixty (60) days or a commercially reasonable period determined by the Seller.

References to Recitals, Sections, and Exhibits are to be the recitals, sections and exhibits of this Agreement.

SECTION 2: TERM; COMMERCIAL OPERATION DATE

2.1. This Agreement shall become effective upon execution by both Parties ("Effective Date").

2.2. Time is of the essence of this Agreement, and Seller's ability to meet certain requirements prior to the Commercial Operation Date and to complete all requirements to establish the Commercial Operation Date is critically important. Therefore,

2.2.1 By November 1, 2019 Seller shall begin initial deliveries of Net Output; and

2.2.2 By December 1, 2019 Seller shall have completed all requirements under Section 1.5 and shall have established the Commercial Operation Date.

2.2.3 Unless the Parties agree in writing that a later Commercial Operation Date is reasonable and necessary, the Commercial Operation Date shall be no more than three (3) years from the Effective Date. PGE will not unreasonably withhold agreement to a Commercial Operation Date that is more than three (3) years from the Effective date if the Seller has demonstrated that a later Commercial Operation Date is reasonable and necessary.

2.3. This Agreement shall terminate on November 1, 2039, or the date the Agreement is terminated in accordance with Section 9 or 11, whichever is earlier ("Termination Date").

SECTION 3: REPRESENTATIONS AND WARRANTIES

3.1. Seller and PGE represent, covenant, and warrant as follows:

3.1.1. Seller warrants it is a Limited Liability Company duly organized under the laws of Oregon.

3.1.2. Seller warrants that the execution and delivery of this Agreement does not contravene any provision of, or constitute a default under, any indenture, mortgage, or other material agreement binding on Seller or any valid order of any court, or any regulatory agency or other body having authority to which Seller is subject.

3.1.3. Seller warrants that the Facility is and shall for the Term of this Agreement continue to be a "Qualifying Facility" ("QF") as that term is defined in the version of 18 C.F.R. Part 292 in effect on the Effective Date. Seller has provided the appropriate QF certification, which may include a Federal Energy Regulatory Commission ("FERC") self-certification to PGE prior to PGE's execution of this Agreement. At any time during the Term of this Agreement, PGE may require Seller to provide PGE with evidence satisfactory to PGE in its reasonable discretion that the Facility continues to qualify as a QF under all applicable requirements.

3.1.4. Seller warrants that it has not within the past two (2) years been the debtor in any bankruptcy proceeding, and Seller is and will continue to be for the Term of this Agreement current on all of its financial obligations.

3.1.5. Seller warrants that during the Term of this Agreement, all of Seller's right, title and interest in and to the Facility shall be free and clear of all liens and encumbrances other than liens and encumbrances arising from third-party financing of the Facility other than workers', mechanics', suppliers' or similar liens, or tax liens, in each case arising in the ordinary course of business that are either not yet due and payable or that have been released by means of a performance bond acceptable to PGE posted within eight (8) calendar days of the commencement of any proceeding to foreclose the lien.

3.1.6. Seller warrants that it will design and operate the Facility consistent with Prudent Electrical Practices.

3.1.7. Seller warrants that the Facility has a Nameplate Capacity Rating not greater than 10,000 kW.

3.1.8. Seller warrants that Net Dependable Capacity of the Facility is 2,500 kW.

3.1.9. Seller estimates that the average annual Net Output to be delivered by the Facility to PGE is 5,184,525 kilowatt-hours ("kWh"), which amount PGE will include in its resource planning.

3.1.10. Seller represents and warrants that the Facility shall achieve the following Mechanical Availability Percentages ("Guarantee of Mechanical Availability"):

3.1.10.1 Ninety percent (90%) beginning in the first Contract Year and extending through the Term for the Facility, if the Facility was operational and sold electricity to PGE or another buyer prior to the Effective Date of this Agreement; or

3.1.10.2 Ninety percent (90%) beginning in Contract Year three and extending throughout the remainder of the Term.

3.1.10.3 Annually, within 90 days of the end of each Contract Year Seller shall send to PGE a detailed written report demonstrating and providing evidence of the actual MAP for the previous Contract Year.

3.1.10.4 Seller's failure to meet the Guarantee of Mechanical Availability in a Calendar Year shall result in damages payable to PGE by Seller equal to the Lost Energy Value. PGE shall bill Seller for such damages in accordance with Section 8.

3.1.11. Seller will deliver from the Facility to PGE at the Point of Delivery Net Output not to exceed a maximum of 5,492,157 kWh of Net Output during each Contract Year ("Maximum Net Output").

3.1.12. By the Commercial Operation Date, Seller has entered into a Generation Interconnection Agreement for a term not less than the term of this Agreement.

3.1.13. PGE warrants that it has not within the past two (2) years been the debtor in any bankruptcy proceeding, and PGE is and will continue to be for the Term of this Agreement current on all of its financial obligations.

3.1.14. Seller warrants that (i) the Facility satisfies the eligibility requirements specified in the Definition of a Small Cogeneration Facility or Small Power Production Facility Eligible to Receive the Standard Renewable Rates and Standard Renewable PPA in PGE's Schedule and (ii) Seller will not make any changes in its ownership, control or management during the term of this Agreement that would cause it to not be in compliance with the Definition of a Small Cogeneration Facility or Small Power Production Facility Eligible to Receive the Standard Renewable Rates and Standard Renewable PPA in PGE's Schedule. Seller will provide, upon request by PGE not more frequently than every 36 months, such documentation and information as may be reasonably required to establish Seller's continued compliance with such Definition. PGE agrees to take reasonable steps to maintain the confidentiality of any portion of the above described documentation and information that the Seller identifies as confidential except PGE will provide all such confidential information to the Public Utility Commission of Oregon upon the Commission's request.

3.1.15. Seller warrants that it will comply with all requirements necessary for all Transferred RECs (as defined in Section 4.5) associated with Net Output to be issued, monitored, accounted for, and transferred by and through the Western Renewable Energy Generation System consistent with the provisions of OAR 330-160-0005 through OAR 330-160-0050. PGE warrants that it will reasonably cooperate in Seller's efforts to meet such requirements, including, for example serving as the qualified reporting entity for the Facility if the Facility is located in PGE's balancing authority.

SECTION 4: DELIVERY OF POWER, PRICE AND ENVIRONMENTAL ATTRIBUTES

4.1. Commencing on the Effective Date and continuing through the Term of this Agreement, Seller shall sell to PGE the entire Net Output delivered from the Facility at the Point of Delivery.

4.2. PGE shall pay Seller the Contract Price for all delivered Net Output. For the first 15 years measured from the date in Section 2.2.2, the Contract Price will be the Renewable Fixed Price Option under the Schedule; thereafter and for the remainder of the Term, the Contract Price will be equal to the Mid-C Index Price.

4.3. Upon completion of construction of the Facility, Seller shall provide PGE an As-built Supplement to specify the actual Facility as built. Seller shall not increase the Nameplate Capacity Rating above that specified in Exhibit A or increase the ability of the Facility to deliver Net Output in quantities in excess of the Net Dependable Capacity, or the Maximum Net Output as described in Section 3.1.11 above, through any means including, but not limited to, replacement, modification, or addition of existing equipment, except with prior written notice to PGE. In the event Seller increases the Nameplate Capacity Rating of the Facility to no more than 10,000 kW pursuant to this section, PGE shall pay the Contract Price for the additional delivered Net Output. In the event Seller increases the Nameplate Capacity Rating to greater than 10,000 kW, then Seller shall be required to enter into a new power purchase agreement for all delivered Net Output proportionally related to the increase of Nameplate Capacity above 10,000 kW.

4.4. To the extent not otherwise provided in the Generation Interconnection Agreement, all costs associated with the modifications to PGE's interconnection facilities or electric system occasioned by or related to the interconnection of the Facility with PGE's system, or any increase in generating capability of the Facility, or any increase of delivery of Net Dependable Capacity from the Facility, shall be borne by Seller.

4.5. From the start of the Renewable Resource Deficiency Period through the remainder of the Term of this Agreement, Seller shall provide and PGE shall acquire the RPS Attributes for the Contract Years as specified in the Schedule and Seller shall retain ownership of all other Environmental Attributes (if any). During the Renewable Resource Sufficiency Period, Seller shall retain all Environmental Attributes in accordance with the Schedule. The Contract Price includes full payment for the Net Output and any RPS Attributes transferred to PGE under this Agreement. With respect to Environmental Attributes not transferred to PGE under this Agreement ("Seller-Retained Environmental Attributes") Seller may report under §1605(b) of the Energy Policy Act of 1992 or under any applicable program as belonging to Seller any of the Seller-Retained Environmental Attributes, and PGE shall not report under such program that such Seller-Retained Environmental Attributes belong to it. With respect to RPS Attributes transferred to PGE under this Agreement ("Transferred RECs"), PGE may report under §1605(b) of the Energy Policy Act of 1992 or under any applicable program as belonging to it any of the Transferred RECs, and Seller shall not report under such program that such Transferred RECs belong to it.

SECTION 5: OPERATION AND CONTROL

5.1. Seller shall operate and maintain the Facility in a safe manner in accordance with the Generation Interconnection Agreement, and Prudent Electrical Practices. PGE shall have no obligation to purchase Net Output from the Facility to the extent the interconnection of the Facility to PGE's electric system is disconnected, suspended or interrupted, in whole or in part, pursuant to the Generation Interconnection Agreement, or to the extent generation curtailment is required as a result of Seller's noncompliance with the Generation Interconnection Agreement. Seller is solely responsible for the operation and maintenance of the Facility. PGE shall not, by reason of its decision to inspect or not to inspect the Facility, or by any action or inaction taken with respect to any such inspection, assume or be held responsible for any liability or occurrence arising from the operation and maintenance by Seller of the Facility.

5.2. Seller agrees to provide sixty (60) days advance written notice of any scheduled maintenance that would require shut down of the Facility for any period of time.

5.3. If the Facility ceases operation for unscheduled maintenance, Seller immediately shall notify PGE of the necessity of such unscheduled maintenance, the time when such maintenance has occurred or will occur, and the anticipated duration of such maintenance. Seller shall take all reasonable measures and exercise its best efforts to avoid unscheduled maintenance, to limit the duration of such unscheduled maintenance, and to perform unscheduled maintenance during Off-Peak hours.

SECTION 6: CREDITWORTHINESS

In the event Seller: a) is unable to represent or warrant as required by Section 3 that it has not been a debtor in any bankruptcy proceeding within the past two (2) years; b) becomes such a debtor during the Term; or c) is not or will not be current on all its financial obligations, Seller shall immediately notify PGE and shall promptly (and in no less than 10 days after notifying PGE) provide default security in an amount reasonably acceptable to PGE in one of the following forms: Senior Lien, Step-in Rights, a Cash Escrow or Letter of Credit. The amount of such default security that shall be acceptable to PGE shall be equal to: (annual On Peak Hours) X (On Peak Price – Off Peak Price) X (Net Dependable Capacity). Notwithstanding the foregoing, in the event Seller is not current on construction related financial obligations, Seller shall notify PGE of such delinquency and PGE may, in its discretion, grant an exception to the requirements to provide default security if the QF has negotiated financial arrangements with the construction loan lender that mitigate Seller's financial risk to PGE.

SECTION 7: METERING

7.1. PGE shall design, furnish, install, own, inspect, test, maintain and replace all metering equipment at Seller's cost and as required pursuant to the Generation Interconnection Agreement.

7.2. Metering shall be performed at the location and in a manner consistent with this Agreement and as specified in the Generation Interconnection Agreement. All Net Output purchased hereunder shall be adjusted to account for electrical losses, if any, between the point of metering and the Point of Delivery, so that the purchased amount reflects the net amount of power flowing into PGE's system at the Point of Delivery.

7.3. PGE shall periodically inspect, test, repair and replace the metering equipment as provided in the Generation Interconnection Agreement. If any of the inspections or tests discloses an error exceeding two (2%) percent of the actual energy delivery, either fast or slow, proper correction, based upon the inaccuracy found, shall be made of previous readings for the actual period during which the metering equipment rendered inaccurate measurements if that period can be ascertained. If the actual period cannot be ascertained, the proper correction shall be made to the measurements taken during the time the metering equipment was in service since last tested, but not exceeding three (3) months, in the amount the metering equipment shall have been shown to be in error by such test. Any correction in billings or payments resulting from a correction in the meter records shall be made in the next monthly billing or payment rendered. Such correction, when made, shall constitute full adjustment of any claim between Seller and PGE arising out of such inaccuracy of metering equipment.

7.4. To the extent not otherwise provided in the Generation Interconnection Agreement, all of PGE's costs relating to all metering equipment installed to accommodate Seller's Facility shall be borne by Seller.

SECTION 8: BILLINGS, COMPUTATIONS AND PAYMENTS

8.1. On or before the thirtieth (30th) day following the end of each Billing Period, PGE shall send to Seller payment for Seller's deliveries of Net Output to PGE, together with computations supporting such payment. PGE may offset any such payment to reflect amounts owing from Seller to PGE pursuant to this Agreement, the Generation Interconnection Agreement, and any other agreement related to the Facility between the Parties or otherwise. On or before the thirtieth (30th) day following the end of each Contract Year, PGE shall bill for any Lost Energy Value accrued pursuant to this Agreement.

8.2. Any amounts owing after the due date thereof shall bear interest at the Prime Rate plus two percent (2%) from the date due until paid; provided, however, that the interest rate shall at no time exceed the maximum rate allowed by applicable law.

SECTION 9: DEFAULT, REMEDIES AND TERMINATION

9.1. In addition to any other event that may constitute a default under this Agreement, the following events shall constitute defaults under this Agreement:

9.1.1. Breach by Seller or PGE of a representation or warranty, except for Section 3.1.4, set forth in this Agreement.

9.1.2. Seller's failure to provide default security, if required by Section 6, prior to delivery of any Net Output to PGE or within 10 days of notice.

9.1.3. Seller's failure to meet the Guarantee of Mechanical Availability established in Section 3.1.10 for two consecutive Contract Years or Seller's failure to provide any written report required by that section.

9.1.4. If Seller is no longer a Qualifying Facility.

9.1.5. Failure of PGE to make any required payment pursuant to Section 8.1.

9.1.6. Seller's failure to meet the Commercial Operation Date.

9.2. In the event of a default under Section 9.1.6, PGE may provide Seller with written notice of default. Seller shall have one year in which to cure the default during which time the Seller shall pay PGE damages equal to the Lost Energy Value. If Seller is unable to cure the default, PGE may immediately terminate this Agreement as provided in Section 9.3. PGE's resource sufficiency/deficiency position shall have no bearing on PGE's right to terminate the Agreement under this Section 9.2.

9.3. In the event of a default under this Agreement, except as otherwise provided in this Agreement, the non-defaulting party may immediately terminate this Agreement at its sole discretion by delivering written notice to the other Party. In addition, the non-defaulting party may pursue any and all legal or equitable remedies provided by law or pursuant to this Agreement including damages related to the need to procure replacement power. A termination hereunder shall be effective upon the date of delivery of notice, as provided in Section 20. The rights provided in this Section 9 are cumulative such that the exercise of one or more rights shall not constitute a waiver of any other rights.

9.4. If this Agreement is terminated as provided in this Section 9 PGE shall make all payments, within thirty (30) days, that, pursuant to the terms of this Agreement, are owed to Seller as of the time of receipt of notice of default. PGE shall not be required to pay Seller for any Net Output delivered by Seller after such notice of default.

9.5. In the event PGE terminates this Agreement pursuant to this Section 9, and Seller wishes to again sell Net Output to PGE following such termination, PGE in its sole discretion may require that Seller shall do so subject to the terms of this Agreement, including but not limited to the Contract Price until the Term of this Agreement (as set forth in Section 2.3) would have run in due course had the Agreement remained in effect. At such time Seller and PGE agree to execute a written document ratifying the terms of this Agreement.

9.6. Sections 9.1, 9.4, 9.5, 10, and 19.2 shall survive termination of this Agreement.

SECTION 10: INDEMNIFICATION AND LIABILITY

10.1. Seller agrees to defend, indemnify and hold harmless PGE, its directors, officers, agents, and representatives against and from any and all loss, claims, actions or suits, including costs and attorney's fees, both at trial and on appeal, resulting from, or arising out of or in any way connected with Seller's delivery of electric power to PGE or with the facilities at or prior to the Point of Delivery, or otherwise arising out of this Agreement, including without limitation any loss, claim, action or suit, for or on account of injury, bodily or otherwise, to, or death of, persons, or for damage to, or destruction or economic loss of property belonging to PGE, Seller or others, excepting to the extent such loss, claim, action or suit may be caused by the negligence of PGE, its directors, officers, employees, agents or representatives.

10.2. PGE agrees to defend, indemnify and hold harmless Seller, its directors, officers, agents, and representatives against and from any and all loss, claims, actions or suits, including costs and attorney's fees, both at trial and on appeal, resulting from, or arising out of or in any way connected with PGE's receipt of electric power from Seller or with the facilities at or after the Point of Delivery, or otherwise arising out of this Agreement, including without limitation any loss, claim, action or suit, for or on account of injury, bodily or otherwise, to, or death of, persons, or for damage to, or destruction or economic loss of property belonging to PGE, Seller or others, excepting to the extent such loss, claim, action or suit may be caused by the negligence of Seller, its directors, officers, employees, agents or representatives.

10.3. Nothing in this Agreement shall be construed to create any duty to, any standard of care with reference to, or any liability to any person not a Party to this Agreement. No undertaking by one Party to the other under any provision of this Agreement shall constitute the dedication of that Party's system or any portion thereof to the other Party or to the public, nor affect the status of PGE as an independent public utility corporation or Seller as an independent individual or entity.

10.4. NEITHER PARTY SHALL BE LIABLE TO THE OTHER FOR SPECIAL, PUNITIVE, INDIRECT OR CONSEQUENTIAL DAMAGES, WHETHER ARISING FROM CONTRACT, TORT (INCLUDING NEGLIGENCE), STRICT LIABILITY OR OTHERWISE.

SECTION 11: INSURANCE

11.1. Prior to the connection of the Facility to PGE's electric system, provided such Facility has a design capacity of 200 kW or more, Seller shall secure and continuously carry for the Term hereof, with an insurance company or companies rated not lower than "B+" by the A. M. Best Company, insurance policies for bodily injury and property damage liability. Such insurance shall include provisions or endorsements naming PGE, its directors, officers and employees as additional insureds; provisions that such insurance is primary insurance with respect to the interest of PGE and that any insurance or self-insurance maintained by PGE is excess and not contributory insurance with the insurance required hereunder; a cross-liability or severability of insurance interest clause; and provisions that such policies shall not be canceled or their limits of liability reduced without thirty (30) days' prior written notice to PGE. Initial

limits of liability for all requirements under this section shall be \$1,000,000 million single limit, which limits may be required to be increased or decreased by PGE as PGE determines in its reasonable judgment economic conditions or claims experience may warrant.

11.2. Prior to the connection of the Facility to PGE's electric system, provided such facility has a design capacity of 200 kW or more, Seller shall secure and continuously carry for the Term hereof, in an insurance company or companies rated not lower than "B+" by the A. M. Best Company, insurance acceptable to PGE against property damage or destruction in an amount not less than the cost of replacement of the Facility. Seller promptly shall notify PGE of any loss or damage to the Facility. Unless the Parties agree otherwise, Seller shall repair or replace the damaged or destroyed Facility, or if the facility is destroyed or substantially destroyed, it may terminate this Agreement. Such termination shall be effective upon receipt by PGE of written notice from Seller. Seller shall waive its insurers' rights of subrogation against PGE regarding Facility property losses.

11.3. Prior to the connection of the Facility to PGE's electric system and at all other times such insurance policies are renewed or changed, Seller shall provide PGE with a copy of each insurance policy required under this Section, certified as a true copy by an authorized representative of the issuing insurance company or, at the discretion of PGE, in lieu thereof, a certificate in a form satisfactory to PGE certifying the issuance of such insurance. If Seller fails to provide PGE with copies of such currently effective insurance policies or certificates of insurance, PGE at its sole discretion and without limitation of other remedies, may upon ten (10) days advance written notice by certified or registered mail to Seller either withhold payments due Seller until PGE has received such documents, or purchase the satisfactory insurance and offset the cost of obtaining such insurance from subsequent power purchase payments under this Agreement.

SECTION 12: FORCE MAJEURE

12.1. As used in this Agreement, "Force Majeure" or "an event of Force Majeure" means any cause beyond the reasonable control of the Seller or of PGE which, despite the exercise of due diligence, such Party is unable to prevent or overcome. By way of example, Force Majeure may include but is not limited to acts of God, fire, flood, storms, wars, hostilities, civil strife, strikes, and other labor disturbances, earthquakes, fires, lightning, epidemics, sabotage, restraint by court order or other delay or failure in the performance as a result of any action or inaction on behalf of a public authority which by the exercise of reasonable foresight such Party could not reasonably have been expected to avoid and by the exercise of due diligence, it shall be unable to overcome, subject, in each case, to the requirements of the first sentence of this paragraph. Force Majeure, however, specifically excludes the cost or availability of resources to operate the Facility, changes in market conditions that affect the price of energy or transmission, wind or water droughts, and obligations for the payment of money when due.

12.2. If either Party is rendered wholly or in part unable to perform its obligation under this Agreement because of an event of Force Majeure, that Party shall be excused from whatever performance is affected by the event of Force Majeure to the

extent and for the duration of the Force Majeure, after which such Party shall recommence performance of such obligation, provided that:

12.2.1. the non-performing Party shall, promptly, but in any case within one (1) week after the occurrence of the Force Majeure, give the other Party written notice describing the particulars of the occurrence; and

12.2.2. the suspension of performance shall be of no greater scope and of no longer duration than is required by the Force Majeure; and

12.2.3. the non-performing Party uses its best efforts to remedy its inability to perform its obligations under this Agreement.

12.3. No obligations of either Party which arose before the Force Majeure causing the suspension of performance shall be excused as a result of the Force Majeure.

12.4. Neither Party shall be required to settle any strike, walkout, lockout or other labor dispute on terms which, in the sole judgment of the Party involved in the dispute, are contrary to the Party's best interests.

SECTION 13: SEVERAL OBLIGATIONS

Nothing contained in this Agreement shall ever be construed to create an association, trust, partnership or joint venture or to impose a trust or partnership duty, obligation or liability between the Parties. If Seller includes two or more parties, each such party shall be jointly and severally liable for Seller's obligations under this Agreement.

SECTION 14: CHOICE OF LAW

This Agreement shall be interpreted and enforced in accordance with the laws of the state of Oregon, excluding any choice of law rules which may direct the application of the laws of another jurisdiction.

SECTION 15: PARTIAL INVALIDITY AND PURPA REPEAL

It is not the intention of the Parties to violate any laws governing the subject matter of this Agreement. If any of the terms of the Agreement are finally held or determined to be invalid, illegal or void as being contrary to any applicable law or public policy, all other terms of the Agreement shall remain in effect. If any terms are finally held or determined to be invalid, illegal or void, the Parties shall enter into negotiations concerning the terms affected by such decision for the purpose of achieving conformity with requirements of any applicable law and the intent of the Parties to this Agreement.

In the event the Public Utility Regulatory Policies Act (PURPA) is repealed, this Agreement shall not terminate prior to the Termination Date, unless such termination is mandated by state or federal law.

SECTION 16: WAIVER

Any waiver at any time by either Party of its rights with respect to a default under this Agreement or with respect to any other matters arising in connection with this

Agreement must be in writing, and such waiver shall not be deemed a waiver with respect to any subsequent default or other matter.

SECTION 17: GOVERNMENTAL JURISDICTION AND AUTHORIZATIONS

This Agreement is subject to the jurisdiction of those governmental agencies having control over either Party or this Agreement. Seller shall at all times maintain in effect all local, state and federal licenses, permits and other approvals as then may be required by law for the construction, operation and maintenance of the Facility, and shall provide upon request copies of the same to PGE.

SECTION 18: SUCCESSORS AND ASSIGNS

This Agreement and all of the terms hereof shall be binding upon and inure to the benefit of the respective successors and assigns of the Parties. No assignment hereof by either Party shall become effective without the written consent of the other Party being first obtained and such consent shall not be unreasonably withheld. Notwithstanding the foregoing, either Party may assign this Agreement without the other Party's consent as part of (a) a sale of all or substantially all of the assigning Party's assets, or (b) a merger, consolidation or other reorganization of the assigning Party.

SECTION 19: ENTIRE AGREEMENT

19.1. This Agreement supersedes all prior agreements, proposals, representations, negotiations, discussions or letters, whether oral or in writing, regarding PGE's purchase of Net Output from the Facility. No modification of this Agreement shall be effective unless it is in writing and signed by both Parties.

19.2. By executing this Agreement, Seller releases PGE from any third party claims related to the Facility, known or unknown, which may have arisen prior to the Effective Date.

SECTION 20: NOTICES

20.1. All notices except as otherwise provided in this Agreement shall be in writing, shall be directed as follows and shall be considered delivered if delivered in person or when deposited in the U.S. Mail, postage prepaid by certified or registered mail and return receipt requested:

To Seller: Walker Creek Solar, LLC
C/O GreenKey Solar, LLC
2455 Laurel Grove Rd
Sutherland, VA 24594

with a copy to:

To PGE: Portland General Electric Company
 QF Contracts, 3WTC0306
 121 SW Salmon St.
 Portland, Oregon 97204

20.2 The Parties may change the person to whom such notices are addressed, or their addresses, by providing written notices thereof in accordance with this Section 20.

IN WITNESS WHEREOF, the Parties hereto have caused this Agreement to be executed in their respective names as of the Effective Date.

PGE

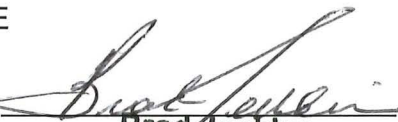
By: 
 Name: Brad Jenkins
 Title: VP Generation & Power Operations
 Date: 6/4/18

PGE Approved By:	
Business Terms	<u>RK</u>
Credit	<u>W</u>
Legal	<u>DPW</u>
Risk Mgt.	<u>JB</u>

Walker Creek Solar, LLC
 (Name Seller)

By: 
 Name: John Hunter Strader
 Title: Authorized Person
 Date: 5/24/2018

EXHIBIT A Facility Description

Facility Description –Walker Creek Solar

Seller's facility is a ground-mounted single-axis tracker solarPV array with an AC capacity of 2,500 kW. The facility will utilize poly-crystalline solar modules (or equivalent). Seller's facility will also include transformers, switchgear, monitoring equipment, fencing and security equipment, and related ancillary equipment necessary to operate a solar photovoltaic generating facility. Exact equipment and nameplate capacity shall be determined by final engineering but shall be materially the same as outlined above.

Seller's facility will interconnect to a PGE distribution line running adjacent to 3169 Zena Rd. Salem, OR 97304 at approximately: Lat: N 45.021°, Long: W -123.095°

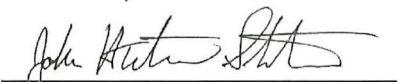
Seller refers to this facility as the "Walker Creek Solar Project."

General Information

1. General Information	
a. Seller	Walker Creek Solar, LLC
b. Project Developer	GreenKey Solar, LLC
c. Project's GPS Coordinate (to 3 decimals)	Lat: N 45.021°, Long: W -123.095°
d. Project's Location (County and State)	Polk County, Oregon
e. Project's AC Name Plate Rating (kW)	2500
f. Project's electrical system to interconnect and the Point of Delivery (POD)	PGE, delivery point is identified on site overview
g. Project's expected energy delivery start date	11/1/2019
h. Project's expected Commercial Operation Date	12/1/2019
i. PPA Termination Date	11/1/2039
j. Seller's Corporation type	Limited Liability Company
k. State of organization	Oregon
l. Project's Net Dependable Capacity (kW)	2500
m. Project's Estimated average annual Net Output (KWh)	5,184,525
n. Project's Maximum annual Net Output (KWh)	5,492,157
o. Notice address line 1	Walker Creek Solar, LLC
p. Notice address line 2	C/O GreenKey Solar LLC
q. Notice address line 3	2455 Laurel Grove Rd
r. Notice address line 4	Sutherland, VA 24594
s. Copy to address line 1 - <i>optional</i>	
t. Copy to address line 2 - <i>optional</i>	
u. Copy to address line 3 - <i>optional</i>	
v. Copy to address line 4 - <i>optional</i>	
w. On a separate sheet include a detailed facility description, including one-line diagram	See "Attachments & Facility Desc." Tab
2. Status of Seller's incorporation	Walker Creek Solar, LLC was formed in Oregon as of 12/08/2017 and is in good standing.
3. Seller's financial statements:	
a. Income statement	n/a
b. Balance sheet	n/a
4. D & B report on seller, of the project sponsor if the seller is not in D & B	Does not exist
5. List of all entities with an ownership interest in the facility	Walker Creek Solar, LLC is wholly owned by GreenKey Solar, LLC, which is wholly owned by John Hunter Strader
6. List all natural persons or persons or any legal entity or entities who:	
a. Share common ownership with Seller	John Hunter Strader/GreeKey Solar, LLC
b. Share common management with Seller	John Hunter Strader/GreeKey Solar, LLC
c. Act jointly or in concert with Seller	John Hunter Strader/GreeKey Solar, LLC
d. Exercise influence over the policies or actions of Seller	John Hunter Strader/GreeKey Solar, LLC
7. The legal name of the manager of the Facility, if applicable	GreenKey Solar, LLC
8. Proof of site control (lease, title to land, property tax bill, or other)	See fully executed LOI from 12/11/2017
9. FERC Form 556 and docket number as proof of submittal and acceptance by FERC	QF18-352-000
10. Map showing adjoining QF sites owned by the Seller	The seller and project entity are one in the same. Ridgeway Solar, LLC does not own any additional projects outside of itself.
11. Map showing adjoining QF sites developed by the Project Developer	See "Attachments & Facility Desc." tab
12. Staffing plan for achieving Commercial Operation	Hire an EPC contractor
13. Status of interconnection and transmission agreements	Interconnection Application Filed
14. Does Seller have FERC Market Based Rate Authority? If yes provide docket #.	No

Location of facility	
1. Facility physical address	3169 Zena Rd. Salem, OR 97304
2. Legal description of parcel (proof of site control to be attached)	Polk County Parcel Number: 265746 & 265762
3. Aerial Facility site boundary map	See "Attachments & Facility Desc." tab
Generation information	
1. Generation	
a. PVsyst (or equivalent) simulation results detail, including but not limited to:	
i. Annual kWh (AC) for the first calendar year of commercial operation	5,184,525
ii. Maximum 24-hr profile of generation kWh (AC) for each month during the first calendar year	See "Attachments & Facility Desc." tab
iii. Average 24-hr profile of generation kWh (AC) for each month during the first calendar year	See "Attachments & Facility Desc." tab
iv. Average and Maximum Project Capacity Factor	P50 YR1 = 23.7% P50 YR20 = 20.5% P1 YR1 = 25.1%
v. Maximum annual output (monthly kWh detail)	See "Attachments & Facility Desc." tab
iv. Loss Diagram	See "Attachments & Facility Desc." tab
Facility Status	
1. Is this facility currently operational (yes/no)	no
a. Is the facility currently contracted in a Power Purchase Agreement (PPA)	no
b. Term of the current PPA (start and end date)	n/a
c. PPA Buyer and Seller	n/a

Facility Characteristics

Solar Facility Characteristics:	Note this information is considered representative design information which is to be updated at the time of project construction and is subject to design finalization
1. Description of Modules:	
a. Module type	JKM 360M-72 V
b. # of modules	8960
c. Max power voltage	39.5
d. Max power current	9.12
e. Max system voltage	1500
f. Total DC system size	3,226
2. Description of Racking	
a. Racking	
i. Type: (fixed tilt, single-axis tracking, or dual-axis tracking, etc.)	single-axis tracking
ii. Tilt angle (if fixed-tilt)	n/a
iii. Azimuth (default = south-facing)	south facing
3. Description of Inverters:	
a. Number of Inverters	20
b. Model	CPS SCH 125 KTL-DO/US-600
c. Maximum Power (kW)	125
d. Operating Voltage (VAC)	480-660 VAC
e. Max. Output Current (A)	121
f. Rated DC Voltage	860-1450 Vdc
g. Rated DC current	250
h. Maximum Output (kW)	125
g. Facility AC Capacity Rating	2500
h. Inverter loading ratio	1.290
i. Facility AC rating	2500
4. Description of transformers	
a. # of transformers	1
b. Model	Cooper 210-12
c. High Voltage Rating	600
d. Low Voltage Rating	TBD
e. MVA rating	2.5
f. High voltage connection	600 A deadbreak one-piece bushings
g. Low voltage connection	Low-voltage 12-, 16-, 20-hole spade (750-2500 kVA)
5. Description of metering, communications, and monitoring	PGE Supplied
6. Description of station service requirements	PGE Supplied
7. Description and timeline of interconnection and transmission plan	Interconnection application submitted/no transmission required
8. Transmission Service Request Number and date request submitted	n/a
9. Interconnection Queue number and date request submitted	Interconnection application submitted to PGE on 12/08/2017 Queue number to be assigned.

PV Syst or Equivalent

PVSYST V6.67		04/01/18	Page 1/6																																	
Grid-Connected System: Simulation parameters																																				
Project : WalkerCreek																																				
Geographical Site	Salem	Country	United States																																	
Situation	Latitude 44.94° N	Longitude	-123.04° W																																	
Time defined as	Legal Time Time zone UT-8	Altitude	48 m																																	
	Albedo 0.20																																			
Meteo data:	Salem	Meteonorm 7.1 (1991-2005) - Synthetic																																		
Simulation variant : New simulation variant																																				
	Simulation date	04/01/18 15h12																																		
Simulation parameters																																				
Tracking plane, tilted Axis	Axis Tilt	0°	Axis Azimuth 0°																																	
Rotation Limitations	Minimum Phi	-60°	Maximum Phi 60°																																	
Models used	Transposition	Perez	Diffuse Perez, Meteonorm																																	
Horizon	Free Horizon																																			
Near Shadings	Linear shadings																																			
PV Array Characteristics																																				
PV module	Si-mono	Model	JKM 360M-72-V																																	
Original PVsyst database	Manufacturer	Jinkosolar																																		
Number of PV modules	In series	28 modules	In parallel 320 strings																																	
Total number of PV modules	Nb. modules	8960	Unit Nom. Power 360 Wp																																	
Array global power	Nominal (STC)	3226 kWp	At operating cond. 2917 kWp (50°C)																																	
Array operating characteristics (50°C)	U mpp	1006 V	I mpp 2900 A																																	
Total area	Module area	17386 m²	Cell area 15313 m²																																	
Inverter																																				
Custom parameters definition	Model	CPS SCH125KTL-DO/US-600																																		
Characteristics	Manufacturer	ChintPower																																		
	Operating Voltage	860-1450 V	Unit Nom. Power 125 kWac																																	
Inverter pack	Nb. of inverters	20 units	Total Power 2500 kWac																																	
PV Array loss factors																																				
Array Soiling Losses	<table border="1"> <thead> <tr> <th>Jan.</th> <th>Feb.</th> <th>Mar.</th> <th>Apr.</th> <th>May</th> <th>June</th> <th>July</th> <th>Aug.</th> <th>Sep.</th> <th>Oct.</th> <th>Nov.</th> <th>Dec.</th> </tr> </thead> <tbody> <tr> <td>3.0%</td> <td>3.0%</td> <td>2.0%</td> <td>1.0%</td> <td>1.0%</td> <td>2.0%</td> <td>2.0%</td> <td>2.0%</td> <td>1.0%</td> <td>1.0%</td> <td>2.0%</td> <td>3.0%</td> </tr> </tbody> </table>												Jan.	Feb.	Mar.	Apr.	May	June	July	Aug.	Sep.	Oct.	Nov.	Dec.	3.0%	3.0%	2.0%	1.0%	1.0%	2.0%	2.0%	2.0%	1.0%	1.0%	2.0%	3.0%
Jan.	Feb.	Mar.	Apr.	May	June	July	Aug.	Sep.	Oct.	Nov.	Dec.																									
3.0%	3.0%	2.0%	1.0%	1.0%	2.0%	2.0%	2.0%	1.0%	1.0%	2.0%	3.0%																									
Thermal Loss factor	Uc (const)	29.0 W/m²K	Uv (wind)	0.0 W/m²K / m/s																																
Wiring Ohmic Loss	Global array res.	5.8 mOhm	Loss Fraction	1.5 % at STC																																
Module Quality Loss			Loss Fraction	-0.8 %																																
Module Mismatch Losses			Loss Fraction	1.0 % at MPP																																
Strings Mismatch loss			Loss Fraction	0.10 %																																
Incidence effect, ASHRAE parametrization	IAM = 1 - bo (1/cos i - 1)		bo Param.	0.05																																
System loss factors																																				
AC wire loss inverter to transfo	Inverter voltage	600 Vac tri																																		
	Wires: 3x2000.0 mm²	180 m	Loss Fraction 1.5 % at STC																																	
External transformer	Iron loss (24H connexion)	3194 W	Loss Fraction 0.1 % at STC																																	
	Resistive/Inductive losses	0.0 mOhm	Loss Fraction 0.0 % at STC																																	

PVsyst Licensed to Seaboard Solar (United States)

Grid-Connected System: Simulation parameters (continued)

User's needs : Unlimited load (grid)

Grid-Connected System: Near shading definition

Project : WalkerCreek

Simulation variant : New simulation variant

Main system parameters	System type	Grid-Connected		
Near Shadings	Linear shadings	tracking, tilted axis, Axis Tilt		
PV Field Orientation	Model	JKM 360M-72-V	Axis Azimuth	0°
PV modules	Nb. of modules	8960	Pnom	360 Wp
PV Array	Model	CPS SCH 125KTL-DO/US-600	Pnom total	3226 kWp
Inverter	Nb. of units	20.0	Pnom total	2500 kW ac
Inverter pack	Unlimited load (grid)			
User's needs				

Perspective of the PV-field and surrounding shading scene

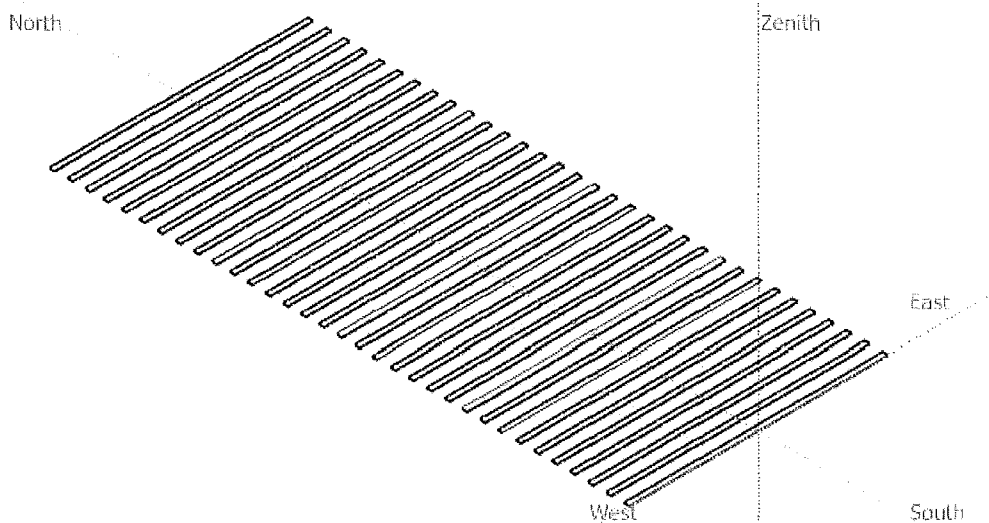

Iso-shadings diagram

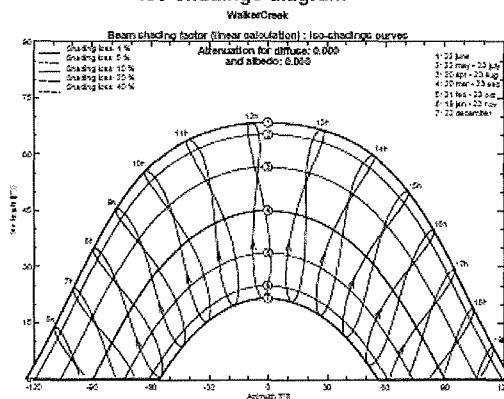

Grid-Connected System: Main results

Project : WalkerCreek
Simulation variant : New simulation variant

Main system parameters		System type Grid-Connected	
Near Shadings	Linear shadings		
PV Field Orientation	tracking, tilted axis, Axis Tilt	0°	Axis Azimuth 0°
PV modules	Model	JKM 360M-72-V	Pnom 360 Wp
PV Array	Nb. of modules	8960	Pnom total 3226 kWp
Inverter	Model	CPS SCH125KTL-DO/US-600	125 kW ac
Inverter pack	Nb. of units	20.0	Pnom total 2500 kW ac
User's needs	Unlimited load (grid)		

Main simulation results
System Production **Produced Energy 5184524720 W/year** Specific prod. 1607 kWh/kWp/year
Performance Ratio PR 87.06 %

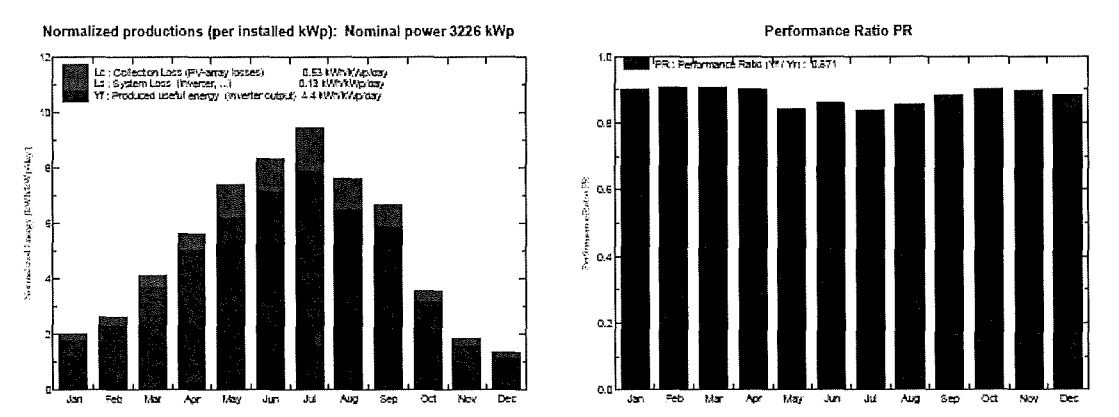

**New simulation variant
Balances and main results**

	GlobHor	DiffHor	T Amb	GlobInc	GlobEff	EArray	E_Grid	PR
	kWh/m²	kWh/m²	°C	kWh/m²	kWh/m²	kWh	kWh	
January	41.2	17.51	4.66	62.8	58.5	189482	182397	0.900
February	55.5	34.23	5.69	72.7	68.2	219196	212012	0.904
March	96.1	66.07	7.53	127.4	121.8	383706	372715	0.907
April	129.7	72.67	9.82	168.6	163.4	504936	490966	0.903
May	168.7	63.84	13.69	226.6	224.0	641050	623512	0.842
June	187.7	89.11	16.41	250.1	240.9	713439	695055	0.861
July	210.2	70.79	20.29	291.7	282.1	807650	786600	0.836
August	172.5	70.47	19.75	236.2	227.6	670221	652832	0.857
September	136.6	49.13	16.65	200.1	194.5	584960	565951	0.883
October	79.1	37.52	11.60	110.4	105.4	330705	326889	0.901
November	40.7	22.75	7.00	64.9	61.7	166269	166721	0.895
December	31.3	20.77	4.66	41.7	39.6	125033	119058	0.886
Year	1349.5	603.88	11.57	1646.2	1777.7	5335240	5184525	0.871

Legends: GlobHor Horizontal global irradiation GlobEff Effective Global, corr. for IAM and shadings
 DiffHor Horizontal diffuse irradiation EArray Effective energy at the output of the array
 T Amb Ambient Temperature E_Grid Energy Injected into grid
 GlobInc Global Incident In coll. plane PR Performance Ratio

Grid-Connected System: Loss diagram

Project : WalkerCreek
Simulation variant : New simulation variant

Main system parameters		System type	Grid-Connected	
Near Shadings	Linear shadings			
PV Field Orientation	tracking, tilted axis, Axis Tilt	0°	Axis Azimuth	0°
PV modules	Model	JKM 360M-72-V	Pnom	360 Wp
PV Array	Nb. of modules	8960	Pnom total	3226 kWp
Inverter	Model	CPS SCH 125KTL-DO/US-600		125 kW ac
Inverter pack	Nb. of units	20.0	Pnom total	2500 kW ac
User's needs	Unlimited load (grid)			

Loss diagram over the whole year

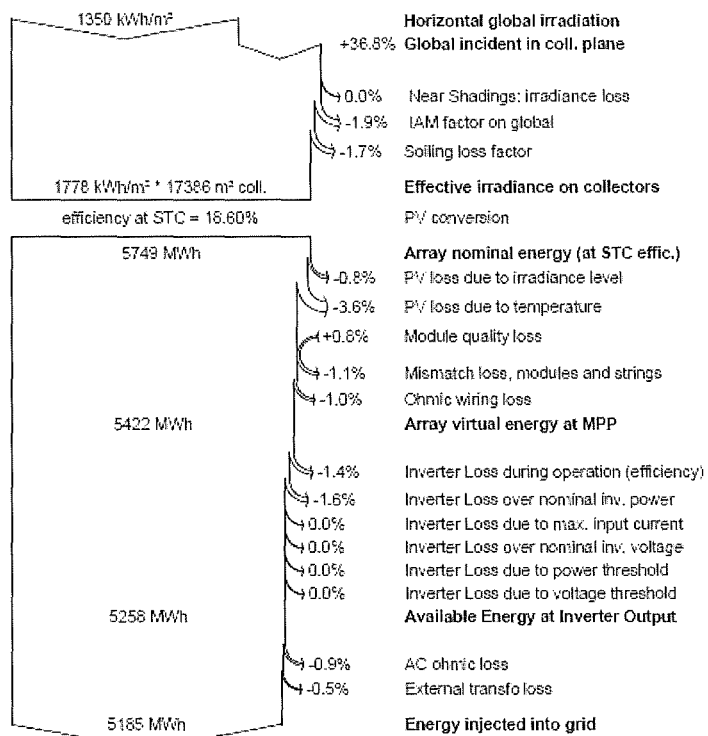

Grid-Connected System: P50 - P90 evaluation

Project : WalkerCreek
Simulation variant : New simulation variant

Main system parameters		System type	Grid-Connected	
Near Shadings		Linear shadings	tracking, tilted axis, Axis Tilt	
PV Field Orientation		Model	JKM 360M-72-V	Axis Azimuth 0°
PV modules		Nb. of modules	8960	Pnom 360 Wp
PV Array		Model	CPS SCH125KTL-DO/US-600	Pnom total 3226 kWp
Inverter		Nb. of units	20.0	125 kW ac
Inverter pack				Pnom total 2500 kW ac
User's needs		Unlimited load (grid)		

Evaluation of the Production probability forecast

The probability distribution of the system production forecast for different years is mainly dependent on the meteo data used for the simulation, and depends on the following choices:

Meteo data source	Meteonorm 7.1 (1991-2005)		
Meteo data	Kind	Not defined	Year 1995
Specified Deviation	Year deviation from aver.	3 %	
Year-to-year variability	Variance	0.5 %	

The probability distribution variance is also depending on some system parameters uncertainties

Specified Deviation	PV module modelling/parameters	2.0 %	
	Inverter efficiency uncertainty	0.5 %	
	Soiling and mismatch uncertainties	1.0 %	
	Degradation uncertainty	1.0 %	
Global variability (meteo + system)	Variance	2.5 %	(quadratic sum)

Annual production probability	Variability	132 MWh
	P50	5185 MWh
	P90	5015 MWh
	P99	4877 MWh

Probability distribution

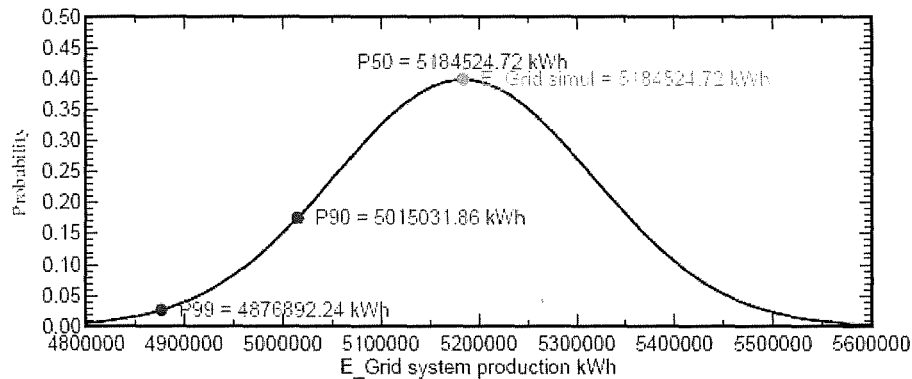

Single Line Diagram

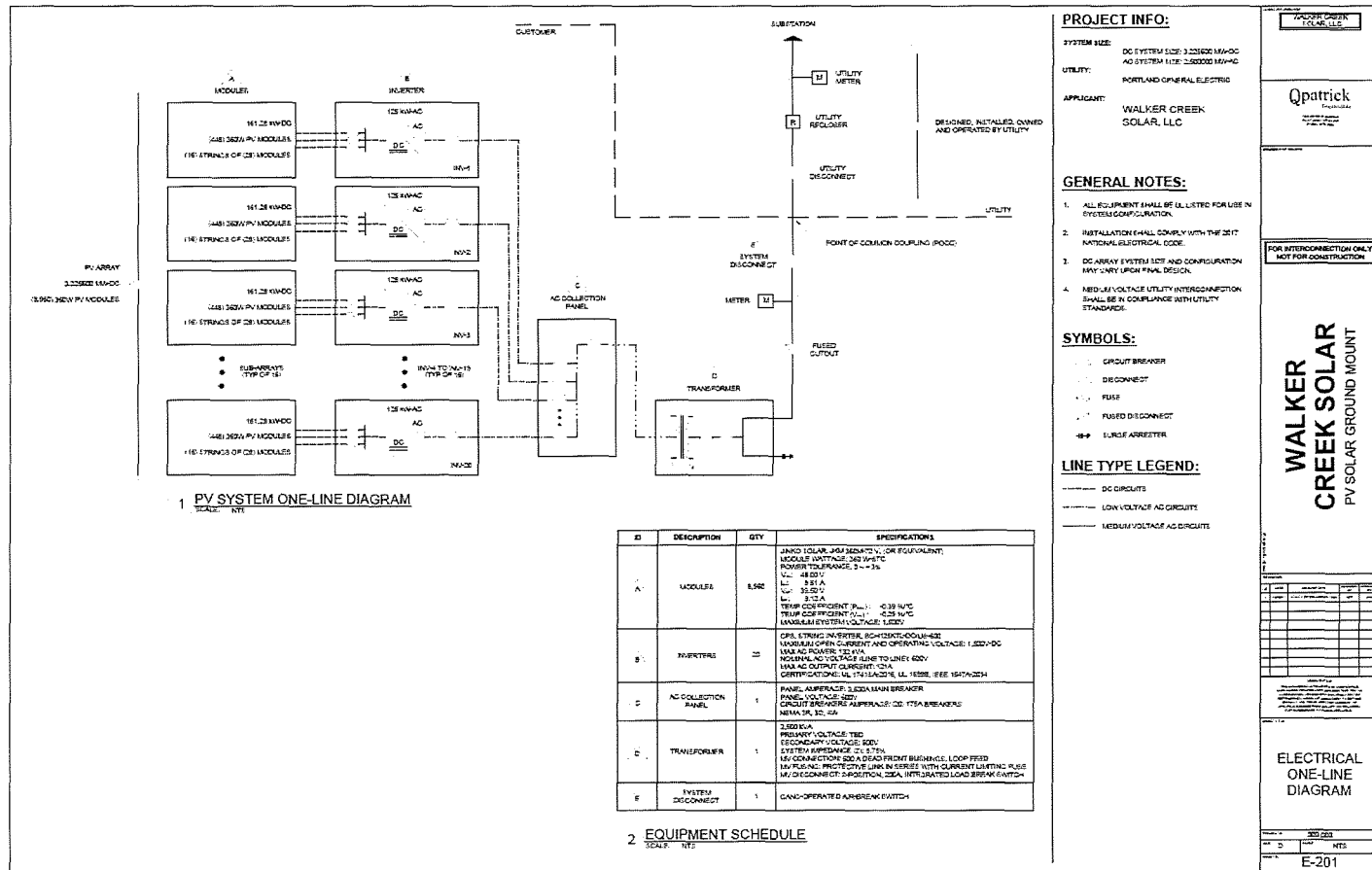

PROJECT INFO:

SYSTEM SIZE: DC SYSTEM SIZE: 2,250KW 144VDC
AC SYSTEM SIZE: 2,500KW 240VAC

UTILITY: PORTLAND GENERAL ELECTRIC

APPLICANT: WALKER CREEK SOLAR, LLC

DESIGNED, INSTALLED, OWNED AND OPERATED BY UTILITY

GENERAL NOTES:

- ALL EQUIPMENT SHALL BE LISTED FOR USE IN SYSTEM CONFIGURATION.
- INSTALLATION SHALL COMPLY WITH THE 2017 NATIONAL ELECTRICAL CODE.
- DC ARRAY SYSTEM SIZE AND CONFIGURATION MAY VARY UPON FINAL DESIGN.
- MEDIUM VOLTAGE UTILITY INTERCONNECTION SHALL BE IN COMPLIANCE WITH UTILITY STANDARDS.

SYMBOLS:

- CIRCUIT BREAKER
- DISCONNECT
- FUSE
- FUSED DISCONNECT
- ⚡ SURGE ARRESTER

LINE TYPE LEGEND:

- DC CIRCUITS
- LOW VOLTAGE AC CIRCUITS
- MEDIUM VOLTAGE AC CIRCUITS

**FOR INTERCONNECTION ONLY
NOT FOR CONSTRUCTION**

WALKER CREEK SOLAR
PV SOLAR GROUND MOUNT

ELECTRICAL ONE-LINE DIAGRAM

300 2023
E-201

Arial Photo or Map



Form 556

Certification of Qualifying Facility (QF) Status for a Small Power
Production or Cogeneration Facility

General

Questions about completing this form should be sent to Form556@ferc.gov. Information about the Commission's QF program, answers to frequently asked questions about QF requirements or completing this form, and contact information for QF program staff are available at the Commission's QF website, www.ferc.gov/QF. The Commission's QF website also provides links to the Commission's QF regulations (18 C.F.R. § 131.80 and Part 292), as well as other statutes and orders pertaining to the Commission's QF program.

Who Must File

Any applicant seeking QF status or recertification of QF status for a generating facility with a net power production capacity (as determined in lines 7a through 7g below) greater than 1000 kW must file a self-certification or an application for Commission certification of QF status, which includes a properly completed Form 556. Any applicant seeking QF status for a generating facility with a net power production capacity 1000 kW or less is exempt from the certification requirement, and is therefore not required to complete or file a Form 556. See 18 C.F.R. § 292.203.

How to Complete the Form 556

This form is intended to be completed by responding to the items in the order they are presented, according to the instructions given. If you need to back-track, you may need to clear certain responses before you will be allowed to change other responses made previously in the form. If you experience problems, click on the nearest help button () for assistance, or contact Commission staff at Form556@ferc.gov.

Certain lines in this form will be automatically calculated based on responses to previous lines, with the relevant formulas shown. You must respond to all of the previous lines within a section before the results of an automatically calculated field will be displayed. If you disagree with the results of any automatic calculation on this form, contact Commission staff at Form556@ferc.gov to discuss the discrepancy before filing.

You must complete all lines in this form unless instructed otherwise. Do not alter this form or save this form in a different format. Incomplete or altered forms, or forms saved in formats other than PDF, will be rejected.

How to File a Completed Form 556

Applicants are required to file their Form 556 electronically through the Commission's eFiling website (see instructions on page 2). By filing electronically, you will reduce your filing burden, save paper resources, save postage or courier charges, help keep Commission expenses to a minimum, and receive a much faster confirmation (via an email containing the docket number assigned to your facility) that the Commission has received your filing.

If you are simultaneously filing both a waiver request and a Form 556 as part of an application for Commission certification, see the "Waiver Requests" section on page 3 for more information on how to file.

Paperwork Reduction Act Notice

This form is approved by the Office of Management and Budget. Compliance with the information requirements established by the FERC Form No. 556 is required to obtain or maintain status as a QF. See 18 C.F.R. § 131.80 and Part 292. An agency may not conduct or sponsor, and a person is not required to respond to, a collection of information unless it displays a currently valid OMB control number. The estimated burden for completing the FERC Form No. 556, including gathering and reporting information, is as follows: 3 hours for self-certification of a small power production facility, 8 hours for self-certifications of a cogeneration facility, 6 hours for an application for Commission certification of a small power production facility, and 50 hours for an application for Commission certification of a cogeneration facility. Send comments regarding this burden estimate or any aspect of this collection of information, including suggestions for reducing this burden, to the following: Information Clearance Officer, Office of the Executive Director (ED-32), Federal Energy Regulatory Commission, 888 First Street N.E., Washington, DC 20426 (DataClearance@ferc.gov); and Desk Officer for FERC, Office of Information and Regulatory Affairs, Office of Management and Budget, Washington, DC 20503 (oir_submission@omb.eop.gov). Include the Control No. 1902-0075 in any correspondence.

Electronic Filing (eFiling)

To electronically file your Form 556, visit the Commission's QF website at www.ferc.gov/QF and click the eFiling link.

If you are eFiling your first document, you will need to register with your name, email address, mailing address, and phone number. If you are registering on behalf of an employer, then you will also need to provide the employer name, alternate contact name, alternate contact phone number and alternate contact email.

Once you are registered, log in to eFiling with your registered email address and the password that you created at registration. Follow the instructions. When prompted, select one of the following QF-related filing types, as appropriate, from the Electric or General filing category.

Filing category	Filing Type as listed in eFiling	Description
Electric	(Fee) Application for Commission Cert. as Cogeneration QF	Use to submit an application for Commission certification or Commission recertification of a cogeneration facility as a QF.
	(Fee) Application for Commission Cert. as Small Power QF	Use to submit an application for Commission certification or Commission recertification of a small power production facility as a QF.
	Self-Certification Notice (QF, EG, FC)	Use to submit a notice of self-certification of your facility (cogeneration or small power production) as a QF.
	Self-Recertification of Qualifying Facility (QF)	Use to submit a notice of self-recertification of your facility (cogeneration or small power production) as a QF.
	Supplemental Information or Request	Use to correct or supplement a Form 556 that was submitted with errors or omissions, or for which Commission staff has requested additional information. Do <i>not</i> use this filing type to report new changes to a facility or its ownership; rather, use a self-recertification or Commission recertification to report such changes.
General	(Fee) Petition for Declaratory Order (not under FPA Part 1)	Use to submit a petition for declaratory order granting a waiver of Commission QF regulations pursuant to 18 C.F.R. §§ 292.204(a) (3) and/or 292.205(c). A Form 556 is not required for a petition for declaratory order unless Commission recertification is being requested as part of the petition.

You will be prompted to submit your filing fee, if applicable, during the electronic submission process. Filing fees can be paid via electronic bank account debit or credit card.

During the eFiling process, you will be prompted to select your file(s) for upload from your computer.

Filing Fee

No filing fee is required if you are submitting a self-certification or self-recertification of your facility as a QF pursuant to 18 C.F.R. § 292.207(a).

A filing fee is required if you are filing either of the following:

- (1) an application for Commission certification or recertification of your facility as a QF pursuant to 18 C.F.R. § 292.207(b), or
- (2) a petition for declaratory order granting waiver pursuant to 18 C.F.R. §§ 292.204(a)(3) and/or 292.205(c).

The current fees for applications for Commission certifications and petitions for declaratory order can be found by visiting the Commission's QF website at www.ferc.gov/QF and clicking the Fee Schedule link.

You will be prompted to submit your filing fee, if applicable, during the electronic filing process described on page 2.

Required Notice to Utilities and State Regulatory Authorities

Pursuant to 18 C.F.R. § 292.207(a)(ii), you must provide a copy of your self-certification or request for Commission certification to the utilities with which the facility will interconnect and/or transact, as well as to the State regulatory authorities of the states in which your facility and those utilities reside. Links to information about the regulatory authorities in various states can be found by visiting the Commission's QF website at www.ferc.gov/QF and clicking the Notice Requirements link.

What to Expect From the Commission After You File

An applicant filing a Form 556 electronically will receive an email message acknowledging receipt of the filing and showing the docket number assigned to the filing. Such email is typically sent within one business day, but may be delayed pending confirmation by the Secretary of the Commission of the contents of the filing.

An applicant submitting a self-certification of QF status should expect to receive no documents from the Commission, other than the electronic acknowledgement of receipt described above. Consistent with its name, a self-certification is a certification *by the applicant itself* that the facility meets the relevant requirements for QF status, and does not involve a determination by the Commission as to the status of the facility. An acknowledgement of receipt of a self-certification, in particular, does not represent a determination by the Commission with regard to the QF status of the facility. An applicant self-certifying may, however, receive a rejection, revocation or deficiency letter if its application is found, during periodic compliance reviews, not to comply with the relevant requirements.

An applicant submitting a request for Commission certification will receive an order either granting or denying certification of QF status, or a letter requesting additional information or rejecting the application. Pursuant to 18 C.F.R. § 292.207(b)(3), the Commission must act on an application for Commission certification within 90 days of the later of the filing date of the application or the filing date of a supplement, amendment or other change to the application.

Waiver Requests

18 C.F.R. § 292.204(a)(3) allows an applicant to request a waiver to modify the method of calculation pursuant to 18 C.F.R. § 292.204(a)(2) to determine if two facilities are considered to be located at the same site, for good cause. 18 C.F.R. § 292.205(c) allows an applicant to request waiver of the requirements of 18 C.F.R. §§ 292.205(a) and (b) for operating and efficiency upon a showing that the facility will produce significant energy savings. A request for waiver of these requirements must be submitted as a petition for declaratory order, with the appropriate filing fee for a petition for declaratory order. Applicants requesting Commission recertification as part of a request for waiver of one of these requirements should electronically submit their completed Form 556 along with their petition for declaratory order, rather than filing their Form 556 as a separate request for Commission recertification. Only the filing fee for the petition for declaratory order must be paid to cover both the waiver request and the request for recertification *if such requests are made simultaneously*.

18 C.F.R. § 292.203(d)(2) allows an applicant to request a waiver of the Form 556 filing requirements, for good cause. Applicants filing a petition for declaratory order requesting a waiver under 18 C.F.R. § 292.203(d)(2) do not need to complete or submit a Form 556 with their petition.

Geographic Coordinates

If a street address does not exist for your facility, then line 3c of the Form 556 requires you to report your facility's geographic coordinates (latitude and longitude). Geographic coordinates may be obtained from several different sources. You can find links to online services that show latitude and longitude coordinates on online maps by visiting the Commission's QF webpage at www.ferc.gov/QF and clicking the Geographic Coordinates link. You may also be able to obtain your geographic coordinates from a GPS device, Google Earth (available free at <http://earth.google.com>), a property survey, various engineering or construction drawings, a property deed, or a municipal or county map showing property lines.

Filing Privileged Data or Critical Energy Infrastructure Information in a Form 556

The Commission's regulations provide procedures for applicants to either (1) request that any information submitted with a Form 556 be given privileged treatment because the information is exempt from the mandatory public disclosure requirements of the Freedom of Information Act, 5 U.S.C. § 552, and should be withheld from public disclosure; or (2) identify any documents containing critical energy infrastructure information (CEII) as defined in 18 C.F.R. § 388.113 that should not be made public.

If you are seeking privileged treatment or CEII status for any data in your Form 556, then you must follow the procedures in 18 C.F.R. § 388.112. See www.ferc.gov/help/filing-guide/file-ceii.asp for more information.

Among other things (see 18 C.F.R. § 388.112 for other requirements), applicants seeking privileged treatment or CEII status for data submitted in a Form 556 must prepare and file both (1) a complete version of the Form 556 (containing the privileged and/or CEII data), and (2) a public version of the Form 556 (with the privileged and/or CEII data redacted). Applicants preparing and filing these different versions of their Form 556 must indicate below the security designation of this version of their document. If you are *not* seeking privileged treatment or CEII status for any of your Form 556 data, then you should not respond to any of the items on this page.

<p>Non-Public: Applicant is seeking privileged treatment and/or CEII status for data contained in the Form 556 lines <input type="checkbox"/> indicated below. This non-public version of the applicant's Form 556 contains all data, including the data that is redacted in the (separate) public version of the applicant's Form 556.</p>
<p>Public (redacted): Applicant is seeking privileged treatment and/or CEII status for data contained in the Form 556 lines <input type="checkbox"/> indicated below. This public version of the applicant's Form 556 contains all data <u>except</u> for data from the lines indicated below, which has been redacted.</p>
<p>Privileged: Indicate below which lines of your form contain data for which you are seeking privileged treatment</p>
<p>Critical Energy Infrastructure Information (CEII): Indicate below which lines of your form contain data for which you are seeking CEII status</p>

The eFiling process described on page 2 will allow you to identify which versions of the electronic documents you submit are public, privileged and/or CEII. The filenames for such documents should begin with "Public", "Priv", or "CEII", as applicable, to clearly indicate the security designation of the file. Both versions of the Form 556 should be unaltered PDF copies of the Form 556, as available for download from www.ferc.gov/QF. To redact data from the public copy of the submittal, simply omit the relevant data from the Form. For numerical fields, leave the redacted fields blank. For text fields, complete as much of the field as possible, and replace the redacted portions of the field with the word "REDACTED" in brackets. Be sure to identify above all fields which contain data for which you are seeking non-public status.

The Commission is not responsible for detecting or correcting filer errors, including those errors related to security designation. If your documents contain sensitive information, make sure they are filed using the proper security designation.

FEDERAL ENERGY REGULATORY COMMISSION
WASHINGTON, DC

OMB Control # 1902-0075
Expiration 06/30/2019

Form 556

Certification of Qualifying Facility (QF) Status for a Small Power
Production or Cogeneration Facility

Application Information

1a Full name of applicant (legal entity on whose behalf qualifying facility status is sought for this facility) Walker Creek Solar, LLC			
1b Applicant street address 2455 Laurel Grove Rd			
1c City Sutherlin		1d State/province VA	
1e Postal code 24594	1f Country (if not United States)		1g Telephone number 919-307-1625
1h Has the instant facility ever previously been certified as a QF? Yes <input type="checkbox"/> No <input checked="" type="checkbox"/>			
1i If yes, provide the docket number of the last known QF filing pertaining to this facility: QF _____ - _____ - _____			
1j Under which certification process is the applicant making this filing? <input checked="" type="checkbox"/> Notice of self-certification (see note below) <input type="checkbox"/> Application for Commission certification (requires filing fee; see "Filing Fee" section on page 3) Note: a notice of self-certification is a notice by the applicant itself that its facility complies with the requirements for QF status. A notice of self-certification does not establish a proceeding, and the Commission does not review a notice of self-certification to verify compliance. See the "What to Expect From the Commission After You File" section on page 3 for more information.			
1k What type(s) of QF status is the applicant seeking for its facility? (check all that apply) <input checked="" type="checkbox"/> Qualifying small power production facility status <input type="checkbox"/> Qualifying cogeneration facility status			
1l What is the purpose and expected effective date(s) of this filing? <input checked="" type="checkbox"/> Original certification; facility expected to be installed by <u>11/1/19</u> and to begin operation on <u>12/1/19</u> <input type="checkbox"/> Change(s) to a previously certified facility to be effective on _____ (identify type(s) of change(s) below, and describe change(s) in the Miscellaneous section starting on page 19) <input type="checkbox"/> Name change and/or other administrative change(s) <input type="checkbox"/> Change in ownership <input type="checkbox"/> Change(s) affecting plant equipment, fuel use, power production capacity and/or cogeneration thermal output <input type="checkbox"/> Supplement or correction to a previous filing submitted on _____ (describe the supplement or correction in the Miscellaneous section starting on page 19)			
1m If any of the following three statements is true, check the box(es) that describe your situation and complete the form to the extent possible, explaining any special circumstances in the Miscellaneous section starting on page 19. <input type="checkbox"/> The instant facility complies with the Commission's QF requirements by virtue of a waiver of certain regulations previously granted by the Commission in an order dated _____ (specify any other relevant waiver orders in the Miscellaneous section starting on page 19) <input type="checkbox"/> The instant facility would comply with the Commission's QF requirements if a petition for waiver submitted concurrently with this application is granted <input type="checkbox"/> The instant facility complies with the Commission's regulations, but has special circumstances, such as the employment of unique or innovative technologies not contemplated by the structure of this form, that make the demonstration of compliance via this form difficult or impossible (describe in Misc. section starting on p. 19)			

Contact Information	2a Name of contact person J Hunter Strader		2b Telephone number 919-307-1625	
	2c Which of the following describes the contact person's relationship to the applicant? (check one) <input type="checkbox"/> Applicant (self) <input checked="" type="checkbox"/> Employee, owner or partner of applicant authorized to represent the applicant <input type="checkbox"/> Employee of a company affiliated with the applicant authorized to represent the applicant on this matter <input type="checkbox"/> Lawyer, consultant, or other representative authorized to represent the applicant on this matter			
	2d Company or organization name (if applicant is an individual, check here and skip to line 2e) <input type="checkbox"/> GreenKey Solar, LLC			
	2e Street address (if same as Applicant, check here and skip to line 3a) <input checked="" type="checkbox"/>			
	2f City		2g State/province	
	2h Postal code		2i Country (if not United States)	
Facility Identification and Location	3a Facility name Walker Creek Solar			
	3b Street address (if a street address does not exist for the facility, check here and skip to line 3c) <input checked="" type="checkbox"/>			
	3c Geographic coordinates: If you indicated that no street address exists for your facility by checking the box in line 3b, then you must specify the latitude and longitude coordinates of the facility in degrees (to three decimal places). Use the following formula to convert to decimal degrees from degrees, minutes and seconds: decimal degrees = degrees + (minutes/60) + (seconds/3600). See the "Geographic Coordinates" section on page 4 for help. If you provided a street address for your facility in line 3b, then specifying the geographic coordinates below is optional. Longitude <input type="checkbox"/> East (+) _____ 123.095 degrees Latitude <input checked="" type="checkbox"/> North (+) _____ 45.021 degrees <input checked="" type="checkbox"/> West (-)			
	3d City (if unincorporated, check here and enter nearest city) <input type="checkbox"/> Salem		3e State/province Oregon	
	3f County (or check here for independent city) <input type="checkbox"/> Polk		3g Country (if not United States)	
Transacting Utilities	Identify the electric utilities that are contemplated to transact with the facility.			
	4a Identify utility interconnecting with the facility Portland General Electric			
	4b Identify utilities providing wheeling service or check here if none <input checked="" type="checkbox"/>			
	4c Identify utilities purchasing the useful electric power output or check here if none <input type="checkbox"/> Portland General Electric			
	4d Identify utilities providing supplementary power, backup power, maintenance power, and/or interruptible power service or check here if none <input type="checkbox"/> Portland General Electric			

Ownership and Operation

5a Direct ownership as of effective date or operation date: Identify all direct owners of the facility holding at least 10 percent equity interest. For each identified owner, also (1) indicate whether that owner is an electric utility, as defined in section 3(22) of the Federal Power Act (16 U.S.C. 796(22)), or a holding company, as defined in section 1262(8) of the Public Utility Holding Company Act of 2005 (42 U.S.C. 16451(8)), and (2) for owners which are electric utilities or holding companies, provide the percentage of equity interest in the facility held by that owner. If no direct owners hold at least 10 percent equity interest in the facility, then provide the required information for the two direct owners with the largest equity interest in the facility.

Full legal names of direct owners	Electric utility or holding company	If Yes, % equity interest
1) Walker Creek Solar, LLC	Yes <input type="checkbox"/> No <input checked="" type="checkbox"/>	_____ %
2) _____	Yes <input type="checkbox"/> No <input type="checkbox"/>	_____ %
3) _____	Yes <input type="checkbox"/> No <input type="checkbox"/>	_____ %
4) _____	Yes <input type="checkbox"/> No <input type="checkbox"/>	_____ %
5) _____	Yes <input type="checkbox"/> No <input type="checkbox"/>	_____ %
6) _____	Yes <input type="checkbox"/> No <input type="checkbox"/>	_____ %
7) _____	Yes <input type="checkbox"/> No <input type="checkbox"/>	_____ %
8) _____	Yes <input type="checkbox"/> No <input type="checkbox"/>	_____ %
9) _____	Yes <input type="checkbox"/> No <input type="checkbox"/>	_____ %
10) _____	Yes <input type="checkbox"/> No <input type="checkbox"/>	_____ %

Check here and continue in the Miscellaneous section starting on page 19 if additional space is needed

5b Upstream (i.e., indirect) ownership as of effective date or operation date: Identify all upstream (i.e., indirect) owners of the facility that both (1) hold at least 10 percent equity interest in the facility, and (2) are electric utilities, as defined in section 3(22) of the Federal Power Act (16 U.S.C. 796(22)), or holding companies, as defined in section 1262(8) of the Public Utility Holding Company Act of 2005 (42 U.S.C. 16451(8)). Also provide the percentage of equity interest in the facility held by such owners. (Note that, because upstream owners may be subsidiaries of one another, total percent equity interest reported may exceed 100 percent.)

Check here if no such upstream owners exist.

Full legal names of electric utility or holding company upstream owners	% equity interest
1) _____	_____ %
2) _____	_____ %
3) _____	_____ %
4) _____	_____ %
5) _____	_____ %
6) _____	_____ %
7) _____	_____ %
8) _____	_____ %
9) _____	_____ %
10) _____	_____ %

Check here and continue in the Miscellaneous section starting on page 19 if additional space is needed

5c Identify the facility operator

Walker Creek Solar, LLC

Energy Input

6a Describe the primary energy input: (check one main category and, if applicable, one subcategory)

- | | | |
|--|---|--|
| <input type="checkbox"/> Biomass (specify) | <input checked="" type="checkbox"/> Renewable resources (specify) | <input type="checkbox"/> Geothermal |
| <input type="checkbox"/> Landfill gas | <input type="checkbox"/> Hydro power - river | <input type="checkbox"/> Fossil fuel (specify) |
| <input type="checkbox"/> Manure digester gas | <input type="checkbox"/> Hydro power - tidal | <input type="checkbox"/> Coal (not waste) |
| <input type="checkbox"/> Municipal solid waste | <input type="checkbox"/> Hydro power - wave | <input type="checkbox"/> Fuel oil/diesel |
| <input type="checkbox"/> Sewage digester gas | <input checked="" type="checkbox"/> Solar - photovoltaic | <input type="checkbox"/> Natural gas (not waste) |
| <input type="checkbox"/> Wood | <input type="checkbox"/> Solar - thermal | <input type="checkbox"/> Other fossil fuel (describe on page 19) |
| <input type="checkbox"/> Other biomass (describe on page 19) | <input type="checkbox"/> Wind | |
| <input type="checkbox"/> Waste (specify type below in line 6b) | <input type="checkbox"/> Other renewable resource (describe on page 19) | <input type="checkbox"/> Other (describe on page 19) |

6b If you specified "waste" as the primary energy input in line 6a, indicate the type of waste fuel used: (check one)

- Waste fuel listed in 18 C.F.R. § 292.202(b) (specify one of the following)
- Anthracite culm produced prior to July 23, 1985
 - Anthracite refuse that has an average heat content of 6,000 Btu or less per pound and has an average ash content of 45 percent or more
 - Bituminous coal refuse that has an average heat content of 9,500 Btu per pound or less and has an average ash content of 25 percent or more
 - Top or bottom subbituminous coal produced on Federal lands or on Indian lands that has been determined to be waste by the United States Department of the Interior's Bureau of Land Management (BLM) or that is located on non-Federal or non-Indian lands outside of BLM's jurisdiction, provided that the applicant shows that the latter coal is an extension of that determined by BLM to be waste
 - Coal refuse produced on Federal lands or on Indian lands that has been determined to be waste by the BLM or that is located on non-Federal or non-Indian lands outside of BLM's jurisdiction, provided that applicant shows that the latter is an extension of that determined by BLM to be waste
 - Lignite produced in association with the production of montan wax and lignite that becomes exposed as a result of such a mining operation
 - Gaseous fuels (except natural gas and synthetic gas from coal) (describe on page 19)
 - Waste natural gas from gas or oil wells (describe on page 19 how the gas meets the requirements of 18 C.F.R. § 2.400 for waste natural gas; include with your filing any materials necessary to demonstrate compliance with 18 C.F.R. § 2.400)
 - Materials that a government agency has certified for disposal by combustion (describe on page 19)
 - Heat from exothermic reactions (describe on page 19)
 - Residual heat (describe on page 19)
 - Used rubber tires
 - Plastic materials
 - Refinery off-gas
 - Petroleum coke
- Other waste energy input that has little or no commercial value and exists in the absence of the qualifying facility industry (describe in the Miscellaneous section starting on page 19; include a discussion of the fuel's lack of commercial value and existence in the absence of the qualifying facility industry)

6c Provide the average energy input, calculated on a calendar year basis, in terms of Btu/h for the following fossil fuel energy inputs, and provide the related percentage of the total average annual energy input to the facility (18 C.F.R. § 292.202(j)). For any oil or natural gas fuel, use lower heating value (18 C.F.R. § 292.202(m)).

Fuel	Annual average energy input for specified fuel	Percentage of total annual energy input
Natural gas	0 Btu/h	0 %
Oil-based fuels	0 Btu/h	0 %
Coal	0 Btu/h	0 %

Technical Facility Information

Indicate the maximum gross and maximum net electric power production capacity of the facility at the point(s) of delivery by completing the worksheet below. Respond to all items. If any of the parasitic loads and/or losses identified in lines 7b through 7e are negligible, enter zero for those lines.

7a The maximum gross power production capacity at the terminals of the individual generator(s) under the most favorable anticipated design conditions	2,500 kW
7b Parasitic station power used at the facility to run equipment which is necessary and integral to the power production process (boiler feed pumps, fans/blowers, office or maintenance buildings directly related to the operation of the power generating facility, etc.). If this facility includes non-power production processes (for instance, power consumed by a cogeneration facility's thermal host), do not include any power consumed by the non-power production activities in your reported parasitic station power.	10 kW
7c Electrical losses in interconnection transformers	15 kW
7d Electrical losses in AC/DC conversion equipment, if any	0 kW
7e Other interconnection losses in power lines or facilities (other than transformers and AC/DC conversion equipment) between the terminals of the generator(s) and the point of interconnection with the utility	0 kW
7f Total deductions from gross power production capacity = 7b + 7c + 7d + 7e	25.0 kW
7g Maximum net power production capacity = 7a - 7f	2,475.0 kW

7h Description of facility and primary components: Describe the facility and its operation. Identify all boilers, heat recovery steam generators, prime movers (any mechanical equipment driving an electric generator), electrical generators, photovoltaic solar equipment, fuel cell equipment and/or other primary power generation equipment used in the facility. Descriptions of components should include (as applicable) specifications of the nominal capacities for mechanical output, electrical output, or steam generation of the identified equipment. For each piece of equipment identified, clearly indicate how many pieces of that type of equipment are included in the plant, and which components are normally operating or normally in standby mode. Provide a description of how the components operate as a system. Applicants for cogeneration facilities do not need to describe operations of systems that are clearly depicted on and easily understandable from a cogeneration facility's attached mass and heat balance diagram; however, such applicants should provide any necessary description needed to understand the sequential operation of the facility depicted in their mass and heat balance diagram. If additional space is needed, continue in the Miscellaneous section starting on page 19.

The facility will consist of photovoltaic modules affixed to ground mounted racks supported on driven piles. The system will utilize one or more inverters.

Information Required for Small Power Production Facility

If you indicated in line 1k that you are seeking qualifying small power production facility status for your facility, then you must respond to the items on this page. Otherwise, skip page 10.

Certification of Compliance with Size Limitations	Pursuant to 18 C.F.R. § 292.204(a), the power production capacity of any small power production facility, together with the power production capacity of any other small power production facilities that use the same energy resource, are owned by the same person(s) or its affiliates, and are located at the same site, may not exceed 80 megawatts. To demonstrate compliance with this size limitation, or to demonstrate that your facility is exempt from this size limitation under the Solar, Wind, Waste, and Geothermal Power Production Incentives Act of 1990 (Pub. L. 101-575, 104 Stat. 2834 (1990) as amended by Pub. L. 102-46, 105 Stat. 249 (1991)), respond to lines 8a through 8e below (as applicable).																
	8a Identify any facilities with electrical generating equipment located within 1 mile of the electrical generating equipment of the instant facility, and for which any of the entities identified in lines 5a or 5b, or their affiliates, holds at least a 5 percent equity interest. Check here if no such facilities exist. <input checked="" type="checkbox"/>																
	<table style="width: 100%; border-collapse: collapse;"> <thead> <tr> <th style="width: 30%; border-bottom: 1px solid black;">Facility location (city or county, state)</th> <th style="width: 20%; border-bottom: 1px solid black;">Root docket # (if any)</th> <th style="width: 30%; border-bottom: 1px solid black;">Common owner(s)</th> <th style="width: 20%; border-bottom: 1px solid black;">Maximum net power production capacity</th> </tr> </thead> <tbody> <tr> <td style="border-bottom: 1px solid black;">1) _____</td> <td style="border-bottom: 1px solid black;">QF - _____</td> <td style="border-bottom: 1px solid black;">_____</td> <td style="border-bottom: 1px solid black;">_____ kW</td> </tr> <tr> <td style="border-bottom: 1px solid black;">2) _____</td> <td style="border-bottom: 1px solid black;">QF - _____</td> <td style="border-bottom: 1px solid black;">_____</td> <td style="border-bottom: 1px solid black;">_____ kW</td> </tr> <tr> <td style="border-bottom: 1px solid black;">3) _____</td> <td style="border-bottom: 1px solid black;">QF - _____</td> <td style="border-bottom: 1px solid black;">_____</td> <td style="border-bottom: 1px solid black;">_____ kW</td> </tr> </tbody> </table>	Facility location (city or county, state)	Root docket # (if any)	Common owner(s)	Maximum net power production capacity	1) _____	QF - _____	_____	_____ kW	2) _____	QF - _____	_____	_____ kW	3) _____	QF - _____	_____	_____ kW
	Facility location (city or county, state)	Root docket # (if any)	Common owner(s)	Maximum net power production capacity													
	1) _____	QF - _____	_____	_____ kW													
	2) _____	QF - _____	_____	_____ kW													
	3) _____	QF - _____	_____	_____ kW													
<input type="checkbox"/> Check here and continue in the Miscellaneous section starting on page 19 if additional space is needed																	
8b The Solar, Wind, Waste, and Geothermal Power Production Incentives Act of 1990 (Incentives Act) provides exemption from the size limitations in 18 C.F.R. § 292.204(a) for certain facilities that were certified prior to 1995. Are you seeking exemption from the size limitations in 18 C.F.R. § 292.204(a) by virtue of the Incentives Act? <input type="checkbox"/> Yes (continue at line 8c below) <input checked="" type="checkbox"/> No (skip lines 8c through 8e)																	
8c Was the original notice of self-certification or application for Commission certification of the facility filed on or before December 31, 1994? Yes <input type="checkbox"/> No <input type="checkbox"/>																	
8d Did construction of the facility commence on or before December 31, 1999? Yes <input type="checkbox"/> No <input type="checkbox"/>																	
8e If you answered No in line 8d, indicate whether reasonable diligence was exercised toward the completion of the facility, taking into account all factors relevant to construction? Yes <input type="checkbox"/> No <input type="checkbox"/> If you answered Yes, provide a brief narrative explanation in the Miscellaneous section starting on page 19 of the construction timeline (in particular, describe why construction started so long after the facility was certified) and the diligence exercised toward completion of the facility.																	
Certification of Compliance with Fuel Use Requirements	Pursuant to 18 C.F.R. § 292.204(b), qualifying small power production facilities may use fossil fuels, in minimal amounts, for only the following purposes: ignition; start-up; testing; flame stabilization; control use; alleviation or prevention of unanticipated equipment outages; and alleviation or prevention of emergencies, directly affecting the public health, safety, or welfare, which would result from electric power outages. The amount of fossil fuels used for these purposes may not exceed 25 percent of the total energy input of the facility during the 12-month period beginning with the date the facility first produces electric energy or any calendar year thereafter.																
	9a Certification of compliance with 18 C.F.R. § 292.204(b) with respect to uses of fossil fuel: <input checked="" type="checkbox"/> Applicant certifies that the facility will use fossil fuels <i>exclusively</i> for the purposes listed above.																
	9b Certification of compliance with 18 C.F.R. § 292.204(b) with respect to amount of fossil fuel used annually: <input checked="" type="checkbox"/> Applicant certifies that the amount of fossil fuel used at the facility will not, in aggregate, exceed 25 percent of the total energy input of the facility during the 12-month period beginning with the date the facility first produces electric energy or any calendar year thereafter.																

Information Required for Cogeneration Facility

If you indicated in line 1k that you are seeking qualifying cogeneration facility status for your facility, then you must respond to the items on pages 11 through 13. Otherwise, skip pages 11 through 13.

General Cogeneration Information	<p>Pursuant to 18 C.F.R. § 292.202(c), a cogeneration facility produces electric energy and forms of useful thermal energy (such as heat or steam) used for industrial, commercial, heating, or cooling purposes, through the sequential use of energy. Pursuant to 18 C.F.R. § 292.202(s), "sequential use" of energy means the following: (1) for a topping-cycle cogeneration facility, the use of reject heat from a power production process in sufficient amounts in a thermal application or process to conform to the requirements of the operating standard contained in 18 C.F.R. § 292.205(a); or (2) for a bottoming-cycle cogeneration facility, the use of at least some reject heat from a thermal application or process for power production.</p>	
	<p>10a What type(s) of cogeneration technology does the facility represent? (check all that apply)</p> <p> <input type="checkbox"/> Topping-cycle cogeneration <input type="checkbox"/> Bottoming-cycle cogeneration </p>	
	<p>10b To help demonstrate the sequential operation of the cogeneration process, and to support compliance with other requirements such as the operating and efficiency standards, include with your filing a mass and heat balance diagram depicting average annual operating conditions. This diagram must include certain items and meet certain requirements, as described below. You must check next to the description of each requirement below to certify that you have complied with these requirements.</p>	
	<p>Check to certify compliance with indicated requirement</p>	<p>Requirement</p>
	<input type="checkbox"/>	Diagram must show orientation within system piping and/or ducts of all prime movers, heat recovery steam generators, boilers, electric generators, and condensers (as applicable), as well as any other primary equipment relevant to the cogeneration process.
	<input type="checkbox"/>	Any average annual values required to be reported in lines 10b, 12a, 13a, 13b, 13d, 13f, 14a, 15b, 15d and/or 15f must be computed over the anticipated hours of operation.
	<input type="checkbox"/>	Diagram must specify all fuel inputs by fuel type and average annual rate in Btu/h. Fuel for supplementary firing should be specified separately and clearly labeled. All specifications of fuel inputs should use lower heating values.
	<input type="checkbox"/>	Diagram must specify average gross electric output in kW or MW for each generator.
	<input type="checkbox"/>	Diagram must specify average mechanical output (that is, any mechanical energy taken off of the shaft of the prime movers for purposes not directly related to electric power generation) in horsepower, if any. Typically, a cogeneration facility has no mechanical output.
	<input type="checkbox"/>	At each point for which working fluid flow conditions are required to be specified (see below), such flow condition data must include mass flow rate (in lb/h or kg/s), temperature (in °F, R, °C or K), absolute pressure (in psia or kPa) and enthalpy (in Btu/lb or kJ/kg). Exception: For systems where the working fluid is <i>liquid only</i> (no vapor at any point in the cycle) and where the type of liquid and specific heat of that liquid are clearly indicated on the diagram or in the Miscellaneous section starting on page 19, only mass flow rate and temperature (not pressure and enthalpy) need be specified. For reference, specific heat at standard conditions for pure liquid water is approximately 1.002 Btu/(lb*R) or 4.195 kJ/(kg*K).
<input type="checkbox"/>	Diagram must specify working fluid flow conditions at input to and output from each steam turbine or other expansion turbine or back-pressure turbine.	
<input type="checkbox"/>	Diagram must specify working fluid flow conditions at delivery to and return from each thermal application.	
<input type="checkbox"/>	Diagram must specify working fluid flow conditions at make-up water inputs.	

EPAAct 2005 Requirements for Fundamental Use of Energy Output from Cogeneration Facilities

EPAAct 2005 cogeneration facilities: The Energy Policy Act of 2005 (EPAAct 2005) established a new section 210(n) of the Public Utility Regulatory Policies Act of 1978 (PURPA), 16 USC 824a-3(n), with additional requirements for any qualifying cogeneration facility that (1) is seeking to sell electric energy pursuant to section 210 of PURPA and (2) was either not a cogeneration facility on August 8, 2005, or had not filed a self-certification or application for Commission certification of QF status on or before February 1, 2006. These requirements were implemented by the Commission in 18 C.F.R. § 292.205(d). Complete the lines below, carefully following the instructions, to demonstrate whether these additional requirements apply to your cogeneration facility and, if so, whether your facility complies with such requirements.

11a Was your facility operating as a qualifying cogeneration facility on or before August 8, 2005? Yes No

11b Was the initial filing seeking certification of your facility (whether a notice of self-certification or an application for Commission certification) filed on or before February 1, 2006? Yes No

If the answer to either line 11a or 11b is Yes, then continue at line 11c below. Otherwise, if the answers to both lines 11a and 11b are No, skip to line 11e below.

11c With respect to the design and operation of the facility, have any changes been implemented on or after February 2, 2006 that affect general plant operation, affect use of thermal output, and/or increase net power production capacity from the plant's capacity on February 1, 2006?

Yes (continue at line 11d below)

No. Your facility is not subject to the requirements of 18 C.F.R. § 292.205(d) at this time. However, it may be subject to these requirements in the future if changes are made to the facility. At such time, the applicant would need to recertify the facility to determine eligibility. Skip lines 11d through 11j.

11d Does the applicant contend that the changes identified in line 11c are not so significant as to make the facility a "new" cogeneration facility that would be subject to the 18 C.F.R. § 292.205(d) cogeneration requirements?

Yes. Provide in the Miscellaneous section starting on page 19 a description of any relevant changes made to the facility (including the purpose of the changes) and a discussion of why the facility should not be considered a "new" cogeneration facility in light of these changes. Skip lines 11e through 11j.

No. Applicant stipulates to the fact that it is a "new" cogeneration facility (for purposes of determining the applicability of the requirements of 18 C.F.R. § 292.205(d)) by virtue of modifications to the facility that were initiated on or after February 2, 2006. Continue below at line 11e.

11e Will electric energy from the facility be sold pursuant to section 210 of PURPA?

Yes. The facility is an EPAAct 2005 cogeneration facility. You must demonstrate compliance with 18 C.F.R. § 292.205(d)(2) by continuing at line 11f below.

No. Applicant certifies that energy will *not* be sold pursuant to section 210 of PURPA. Applicant also certifies its understanding that it must recertify its facility in order to determine compliance with the requirements of 18 C.F.R. § 292.205(d) *before* selling energy pursuant to section 210 of PURPA in the future. Skip lines 11f through 11j.

11f Is the net power production capacity of your cogeneration facility, as indicated in line 7g above, less than or equal to 5,000 kW?

Yes, the net power production capacity is less than or equal to 5,000 kW. 18 C.F.R. § 292.205(d)(4) provides a rebuttable presumption that cogeneration facilities of 5,000 kW and smaller capacity comply with the requirements for fundamental use of the facility's energy output in 18 C.F.R. § 292.205(d)(2). Applicant certifies its understanding that, should the power production capacity of the facility increase above 5,000 kW, then the facility must be recertified to (among other things) demonstrate compliance with 18 C.F.R. § 292.205(d)(2). Skip lines 11g through 11j.

No, the net power production capacity is greater than 5,000 kW. Demonstrate compliance with the requirements for fundamental use of the facility's energy output in 18 C.F.R. § 292.205(d)(2) by continuing on the next page at line 11g.

EPAct 2005 Requirements for Fundamental Use of Energy Output from Cogeneration Facilities (continued)

Lines 11g through 11k below guide the applicant through the process of demonstrating compliance with the requirements for "fundamental use" of the facility's energy output. 18 C.F.R. § 292.205(d)(2). Only respond to the lines on this page if the instructions on the previous page direct you to do so. Otherwise, skip this page.

18 C.F.R. § 292.205(d)(2) requires that the electrical, thermal, chemical and mechanical output of an EPAct 2005 cogeneration facility is used fundamentally for industrial, commercial, residential or institutional purposes and is not intended fundamentally for sale to an electric utility, taking into account technological, efficiency, economic, and variable thermal energy requirements, as well as state laws applicable to sales of electric energy from a qualifying facility to its host facility. If you were directed on the previous page to respond to the items on this page, then your facility is an EPAct 2005 cogeneration facility that is subject to this "fundamental use" requirement.

The Commission's regulations provide a two-pronged approach to demonstrating compliance with the requirements for fundamental use of the facility's energy output. First, the Commission has established in 18 C.F.R. § 292.205(d)(3) a "fundamental use test" that can be used to demonstrate compliance with 18 C.F.R. § 292.205(d)(2). Under the fundamental use test, a facility is considered to comply with 18 C.F.R. § 292.205(d)(2) if at least 50 percent of the facility's total annual energy output (including electrical, thermal, chemical and mechanical energy output) is used for industrial, commercial, residential or institutional purposes.

Second, an applicant for a facility that does not pass the fundamental use test may provide a narrative explanation of and support for its contention that the facility nonetheless meets the requirement that the electrical, thermal, chemical and mechanical output of an EPAct 2005 cogeneration facility is used fundamentally for industrial, commercial, residential or institutional purposes and is not intended fundamentally for sale to an electric utility, taking into account technological, efficiency, economic, and variable thermal energy requirements, as well as state laws applicable to sales of electric energy from a qualifying facility to its host facility.

Complete lines 11g through 11j below to determine compliance with the fundamental use test in 18 C.F.R. § 292.205(d)(3). Complete lines 11g through 11j *even if you do not intend to rely upon the fundamental use test to demonstrate compliance with 18 C.F.R. § 292.205(d)(2)*.

11g Amount of electrical, thermal, chemical and mechanical energy output (net of internal generation plant losses and parasitic loads) expected to be used annually for industrial, commercial, residential or institutional purposes and not sold to an electric utility	MWh
--	-----

11h Total amount of electrical, thermal, chemical and mechanical energy expected to be sold to an electric utility	MWh
---	-----

11i Percentage of total annual energy output expected to be used for industrial, commercial, residential or institutional purposes and not sold to a utility = 100 * 11g / (11g + 11h)	0 %
--	-----

11j Is the response in line 11i greater than or equal to 50 percent?

Yes. Your facility complies with 18 C.F.R. § 292.205(d)(2) by virtue of passing the fundamental use test provided in 18 C.F.R. § 292.205(d)(3). Applicant certifies its understanding that, if it is to rely upon passing the fundamental use test as a basis for complying with 18 C.F.R. § 292.205(d)(2), then the facility must comply with the fundamental use test both in the 12-month period beginning with the date the facility first produces electric energy, and in all subsequent calendar years.

No. Your facility does not pass the fundamental use test. Instead, you must provide in the Miscellaneous section starting on page 19 a narrative explanation of and support for why your facility meets the requirement that the electrical, thermal, chemical and mechanical output of an EPAct 2005 cogeneration facility is used fundamentally for industrial, commercial, residential or institutional purposes and is not intended fundamentally for sale to an electric utility, taking into account technological, efficiency, economic, and variable thermal energy requirements, as well as state laws applicable to sales of electric energy from a QF to its host facility. Applicants providing a narrative explanation of why their facility should be found to comply with 18 C.F.R. § 292.205(d)(2) in spite of non-compliance with the fundamental use test may want to review paragraphs 47 through 61 of Order No. 671 (accessible from the Commission's QF website at www.ferc.gov/QF), which provide discussion of the facts and circumstances that may support their explanation. Applicant should also note that the percentage reported above will establish the standard that that facility must comply with, both for the 12-month period beginning with the date the facility first produces electric energy, and in all subsequent calendar years. See Order No. 671 at paragraph 51. As such, the applicant should make sure that it reports appropriate values on lines 11g and 11h above to serve as the relevant annual standard, taking into account expected variations in production conditions.

Information Required for Topping-Cycle Cogeneration Facility

If you indicated in line 10a that your facility represents topping-cycle cogeneration technology, then you must respond to the items on pages 14 and 15. Otherwise, skip pages 14 and 15.

Usefulness of Topping-Cycle Thermal Output	<p>The thermal energy output of a topping-cycle cogeneration facility is the net energy made available to an industrial or commercial process or used in a heating or cooling application. Pursuant to sections 292.202(c), (d) and (h) of the Commission's regulations (18 C.F.R. §§ 292.202(c), (d) and (h)), the thermal energy output of a qualifying topping-cycle cogeneration facility must be useful. In connection with this requirement, describe the thermal output of the topping-cycle cogeneration facility by responding to lines 12a and 12b below.</p>			
	<p>12a Identify and describe each thermal host, and specify the annual average rate of thermal output made available to each host for each use. For hosts with multiple uses of thermal output, provide the data for each use <i>in separate rows</i>.</p>			
		<p>Name of entity (thermal host) taking thermal output</p>	<p>Thermal host's relationship to facility; Thermal host's use of thermal output</p>	<p>Average annual rate of thermal output attributable to use (net of heat contained in process return or make-up water)</p>
	1)		Select thermal host's relationship to facility	Btu/h
			Select thermal host's use of thermal output	
	2)		Select thermal host's relationship to facility	Btu/h
			Select thermal host's use of thermal output	
	3)		Select thermal host's relationship to facility	Btu/h
			Select thermal host's use of thermal output	
	4)		Select thermal host's relationship to facility	Btu/h
		Select thermal host's use of thermal output		
5)		Select thermal host's relationship to facility	Btu/h	
		Select thermal host's use of thermal output		
6)		Select thermal host's relationship to facility	Btu/h	
		Select thermal host's use of thermal output		
<p><input type="checkbox"/> Check here and continue in the Miscellaneous section starting on page 19 if additional space is needed</p>				
<p>12b Demonstration of usefulness of thermal output: At a minimum, provide a brief description of each use of the thermal output identified above. In some cases, this brief description is sufficient to demonstrate usefulness. However, if your facility's use of thermal output is not common, and/or if the usefulness of such thermal output is not reasonably clear, then you must provide additional details as necessary to demonstrate usefulness. Your application may be rejected and/or additional information may be required if an insufficient showing of usefulness is made. (Exception: If you have previously received a Commission certification approving a specific use of thermal output related to the instant facility, then you need only provide a brief description of that use and a reference by date and docket number to the order certifying your facility with the indicated use. Such exemption may not be used if any change creates a material deviation from the previously authorized use.) If additional space is needed, continue in the Miscellaneous section starting on page 19.</p>				

Topping-Cycle Operating and Efficiency Value Calculation

Applicants for facilities representing topping-cycle technology must demonstrate compliance with the topping-cycle operating standard and, if applicable, efficiency standard. Section 292.205(a)(1) of the Commission's regulations (18 C.F.R. § 292.205(a)(1)) establishes the operating standard for topping-cycle cogeneration facilities: the useful thermal energy output must be no less than 5 percent of the total energy output. Section 292.205(a)(2) (18 C.F.R. § 292.205(a)(2)) establishes the efficiency standard for topping-cycle cogeneration facilities for which installation commenced on or after March 13, 1980: the useful power output of the facility plus one-half the useful thermal energy output must (A) be no less than 42.5 percent of the total energy input of natural gas and oil to the facility; and (B) if the useful thermal energy output is less than 15 percent of the total energy output of the facility, be no less than 45 percent of the total energy input of natural gas and oil to the facility. To demonstrate compliance with the topping-cycle operating and/or efficiency standards, or to demonstrate that your facility is exempt from the efficiency standard based on the date that installation commenced, respond to lines 13a through 13l below.

If you indicated in line 10a that your facility represents *both* topping-cycle and bottoming-cycle cogeneration technology, then respond to lines 13a through 13l below considering only the energy inputs and outputs attributable to the topping-cycle portion of your facility. Your mass and heat balance diagram must make clear which mass and energy flow values and system components are for which portion (topping or bottoming) of the cogeneration system.

13a Indicate the annual average rate of useful thermal energy output made available to the host(s), net of any heat contained in condensate return or make-up water	Btu/h
13b Indicate the annual average rate of net electrical energy output	kW
13c Multiply line 13b by 3,412 to convert from kW to Btu/h	0 Btu/h
13d Indicate the annual average rate of mechanical energy output taken directly off of the shaft of a prime mover for purposes not directly related to power production (this value is usually zero)	hp
13e Multiply line 13d by 2,544 to convert from hp to Btu/h	0 Btu/h
13f Indicate the annual average rate of energy input from natural gas and oil	Btu/h
13g Topping-cycle operating value = $100 * 13a / (13a + 13c + 13e)$	0 %
13h Topping-cycle efficiency value = $100 * (0.5*13a + 13c + 13e) / 13f$	0 %

13i Compliance with operating standard: Is the operating value shown in line 13g greater than or equal to 5%?
 Yes (complies with operating standard) No (does not comply with operating standard)

13j Did installation of the facility in its current form commence on or after March 13, 1980?
 Yes. Your facility is subject to the efficiency requirements of 18 C.F.R. § 292.205(a)(2). Demonstrate compliance with the efficiency requirement by responding to line 13k or 13l, as applicable, below.
 No. Your facility is exempt from the efficiency standard. Skip lines 13k and 13l.

13k Compliance with efficiency standard (for low operating value): If the operating value shown in line 13g is less than 15%, then indicate below whether the efficiency value shown in line 13h greater than or equal to 45%:
 Yes (complies with efficiency standard) No (does not comply with efficiency standard)

13l Compliance with efficiency standard (for high operating value): If the operating value shown in line 13g is greater than or equal to 15%, then indicate below whether the efficiency value shown in line 13h is greater than or equal to 42.5%:
 Yes (complies with efficiency standard) No (does not comply with efficiency standard)

Information Required for Bottoming-Cycle Cogeneration Facility

If you indicated in line 10a that your facility represents bottoming-cycle cogeneration technology, then you must respond to the items on pages 16 and 17. Otherwise, skip pages 16 and 17.

Usefulness of Bottoming-Cycle Thermal Output	The thermal energy output of a bottoming-cycle cogeneration facility is the energy related to the process(es) from which at least some of the reject heat is then used for power production. Pursuant to sections 292.202(c) and (e) of the Commission's regulations (18 C.F.R. § 292.202(c) and (e)), the thermal energy output of a qualifying bottoming-cycle cogeneration facility must be useful. In connection with this requirement, describe the process(es) from which at least some of the reject heat is used for power production by responding to lines 14a and 14b below.		
	14a Identify and describe each thermal host and each bottoming-cycle cogeneration process engaged in by each host. For hosts with multiple bottoming-cycle cogeneration processes, provide the data for each process <i>in separate rows</i> .		
	Name of entity (thermal host) performing the process from which at least some of the reject heat is used for power production	Thermal host's relationship to facility; Thermal host's process type	Has the energy input to the thermal host been augmented for purposes of increasing power production capacity? (if Yes, describe on p. 19)
	1)	Select thermal host's relationship to facility Select thermal host's process type	Yes <input type="checkbox"/> No <input type="checkbox"/>
	2)	Select thermal host's relationship to facility Select thermal host's process type	Yes <input type="checkbox"/> No <input type="checkbox"/>
	3)	Select thermal host's relationship to facility Select thermal host's process type	Yes <input type="checkbox"/> No <input type="checkbox"/>
	<input type="checkbox"/> Check here and continue in the Miscellaneous section starting on page 19 if additional space is needed		
	14b Demonstration of usefulness of thermal output: At a minimum, provide a brief description of each process identified above. In some cases, this brief description is sufficient to demonstrate usefulness. However, if your facility's process is not common, and/or if the usefulness of such thermal output is not reasonably clear, then you must provide additional details as necessary to demonstrate usefulness. Your application may be rejected and/or additional information may be required if an insufficient showing of usefulness is made. (Exception: If you have previously received a Commission certification approving a specific bottoming-cycle process related to the instant facility, then you need only provide a brief description of that process and a reference by date and docket number to the order certifying your facility with the indicated process. Such exemption may not be used if any material changes to the process have been made.) If additional space is needed, continue in the Miscellaneous section starting on page 19.		

Bottoming-Cycle Operating and Efficiency Value Calculation

Applicants for facilities representing bottoming-cycle technology and for which installation commenced on or after March 13, 1990 must demonstrate compliance with the bottoming-cycle efficiency standards. Section 292.205(b) of the Commission's regulations (18 C.F.R. § 292.205(b)) establishes the efficiency standard for bottoming-cycle cogeneration facilities: the useful power output of the facility must be no less than 45 percent of the energy input of natural gas and oil for supplementary firing. To demonstrate compliance with the bottoming-cycle efficiency standard (if applicable), or to demonstrate that your facility is exempt from this standard based on the date that installation of the facility began, respond to lines 15a through 15h below.

If you indicated in line 10a that your facility represents *both* topping-cycle and bottoming-cycle cogeneration technology, then respond to lines 15a through 15h below considering only the energy inputs and outputs attributable to the bottoming-cycle portion of your facility. Your mass and heat balance diagram must make clear which mass and energy flow values and system components are for which portion of the cogeneration system (topping or bottoming).

15a Did installation of the facility in its current form commence on or after March 13, 1980?

Yes. Your facility is subject to the efficiency requirement of 18 C.F.R. § 292.205(b). Demonstrate compliance with the efficiency requirement by responding to lines 15b through 15h below.

No. Your facility is exempt from the efficiency standard. Skip the rest of page 17.

15b Indicate the annual average rate of net electrical energy output	kW
---	----

15c Multiply line 15b by 3,412 to convert from kW to Btu/h	0 Btu/h
---	---------

15d Indicate the annual average rate of mechanical energy output taken directly off of the shaft of a prime mover for purposes not directly related to power production (this value is usually zero)	hp
---	----

15e Multiply line 15d by 2,544 to convert from hp to Btu/h	0 Btu/h
---	---------

15f Indicate the annual average rate of supplementary energy input from natural gas or oil	Btu/h
---	-------

15g Bottoming-cycle efficiency value = $100 * (15c + 15e) / 15f$	0 %
---	-----

15h Compliance with efficiency standard: Indicate below whether the efficiency value shown in line 15g is greater than or equal to 45%:

Yes (complies with efficiency standard) No (does not comply with efficiency standard)

Miscellaneous

Use this space to provide any information for which there was not sufficient space in the previous sections of the form to provide. For each such item of information *clearly identify the line number that the information belongs to*. You may also use this space to provide any additional information you believe is relevant to the certification of your facility.

Your response below is not limited to one page. Additional page(s) will automatically be inserted into this form if the length of your response exceeds the space on this page. Use as many pages as you require.

**EXHIBIT B
REQUIRED FACILITY DOCUMENTS**

Please complete this list, including but not limited to:

Sellers Generation Interconnection Agreement
All required transmission Agreements
All required environmental permits
All required agreement to record Renewable Energy Certificates
Required site control documents
FERC Self-Certification and acceptance
Any Conditional Use Permits
Any Access Permit
Construction Permits

EXHIBIT C
START-UP TESTING
Required Testing

Required start-up tests are those checks and tests necessary to determine that all features and equipment, systems, and subsystems have been properly designed, manufactured, installed and adjusted, function properly, and are capable of operating simultaneously in such condition that the Facility is capable of continuous delivery into BPA/EIM/PGE's electrical system for delivery to PGE, which may include but are not limited to (as applicable) the following:

1. Safety plan during startup and commissioning (including the expected number of individuals covered)
2. Review of all QA/QC testing
3. Confirm testing and energizing inverters in conformance with manufacturer's recommended procedures; note operating voltages; and confirm inverter is performing as expected
4. Energizing transformers
5. Under full sun conditions, and after at least 15 minutes of operation, taking and recording PV Plant operating data—such as but not limited to KWDC, KWAC, VDC, VAC, IDC, IAC, Solar Radiation, etc.
6. Testing the system control and monitoring system to verify that it is performing correctly
7. Testing the communication system for offsite monitoring and all requirements of the Western Energy Imbalance Market
8. Testing the Plant metering and protective relaying to verify they meet utility requirements
9. Documentation of successful startup and commissioning procedure
10. Written notification submitted by Contractor to Owner that the completion of Acceptance Testing and Commissioning has occurred
11. Testing to meet the requirements of Section 1.5.3.

EXHIBIT D
SCHEDULE 201

**SCHEDULE 201
QUALIFYING FACILITY 10 MW or LESS
AVOIDED COST POWER PURCHASE INFORMATION**

PURPOSE

To provide information about Standard Avoided Costs and Renewable Avoided Costs, Standard Power Purchase Agreements (PPA) and Negotiated PPAs, power purchase prices and price options for power delivered by a Qualifying Facility (QF) to the Company with nameplate capacity of 10,000 kW (10MW) or less.

AVAILABLE

To owners of QFs making sales of electricity to the Company in the State of Oregon (Seller).

APPLICABLE

For power purchased from small power production or cogeneration facilities that are QFs as defined in 18 Code of Federal Regulations (CFR) Section 292, that meet the eligibility requirements described herein and where the energy is delivered to the Company's system and made available for Company purchase pursuant to a Standard PPA.

ESTABLISHING CREDITWORTHINESS

The Seller must establish creditworthiness prior to service under this schedule. For a Standard PPA, a Seller may establish creditworthiness with a written acknowledgment that it is current on all existing debt obligations and that it was not a debtor in a bankruptcy proceeding within the preceding 24 months. If the Seller is not able to establish creditworthiness, the Seller must provide security deemed sufficient by the Company as set forth in the Standard PPA.

POWER PURCHASE INFORMATION

A Seller may call the Power Production Coordinator at (503) 464-8000 to obtain more information about being a Seller or how to apply for service under this schedule.

PPA

In accordance with terms set forth in this schedule and the Commission's Rules as applicable, the Company will purchase any Energy in excess of station service (power necessary to produce generation) and amounts attributable to conversion losses, which are made available from the Seller.

A Seller must execute a PPA with the Company prior to delivery of power to the Company. The agreement will have a term of up to 20 years as selected by the QF and memorialized in the PPA.

A QF with a nameplate capacity rating of 10 MW or less as defined herein may elect the option of a Standard PPA.

SCHEDULE 201 (Continued)

PPA (Continued)

Any Seller may elect to negotiate a PPA with the Company. Such negotiation will comply with the requirements of the Federal Energy Regulatory Commission (FERC), and the Commission including the guidelines in Order No. 07-360, and Schedule 202. Negotiations for power purchase pricing will be based on either the filed Standard Avoided Costs or Renewable Avoided Costs in effect at that time.

STANDARD PPA (Nameplate capacity of 10 MW or less)

A Seller choosing a Standard PPA will complete all informational and price option selection requirements in the applicable Standard PPA and submit the executed Agreement to the Company prior to service under this schedule. The Standard PPA is available at www.portlandgeneral.com. The available Standard PPAs are:

- Standard In-System Non-Variable Power Purchase Agreement
- Standard Off-System Non-Variable Power Purchase Agreement
- Standard In-System Variable Power Purchase Agreement
- Standard Off-System Variable Power Purchase Agreement
- Standard Renewable In-System Non-Variable Power Purchase Agreement
- Standard Renewable Off-System Non-Variable Power Purchase Agreement
- Standard Renewable In-System Variable Power Purchase Agreement
- Standard Renewable Off-System Variable Power Purchase Agreement

The Standard PPAs applicable to variable resources are available only to QFs utilizing wind, solar or run of river hydro as the primary motive force.

GUIDELINES FOR 10 MW OR LESS FACILITIES ELECTING STANDARD PPA

To execute the Standard PPA the Seller must complete all of the general project information requested in the applicable Standard PPA.

When all information required in the Standard PPA has been received in writing from the Seller, the Company will respond within 15 business days with a draft Standard PPA.

The Seller may request in writing that the Company prepare a final draft Standard PPA. The Company will respond to this request within 15 business days. In connection with such request, the QF must provide the Company with any additional or clarified project information that the Company reasonably determines to be necessary for the preparation of a final draft Standard PPA.

When both parties are in full agreement as to all terms and conditions of the draft Standard PPA, the Company will prepare and forward to the Seller a final executable version of the agreement within 15 business days. Following the Company's execution, an executed copy will be returned to the Seller. Prices and other terms and conditions in the PPA will not be final and binding until the Standard PPA has been executed by both parties.

SCHEDULE 201 (Continued)**OFF-SYSTEM PPA**

A Seller with a facility that interconnects with an electric system other than the Company's electric system may enter into a PPA with the Company after following the applicable Standard or Negotiated PPA guidelines and making the arrangements necessary for transmission of power to the Company's system.

BASIS FOR POWER PURCHASE PRICE**AVOIDED COST SUMMARY**

The power purchase prices are based on either the Company's Standard Avoided Costs or Renewable Avoided Costs in effect at the time the agreement is executed. Avoided Costs are defined in 18 CFR 292.101(6) as "the incremental costs to an electric utility of electric energy or capacity or both which, but for the purchase from the qualifying facility or qualifying facilities, such utility would generate itself or purchase from another source."

Monthly On-Peak prices are included in both the Standard Avoided Costs as listed in Tables 1a, 2a, and 3a and Renewable Avoided Costs as listed in Tables 4a, 5a, and 6a. Monthly Off-Peak prices are included in both the Standard Avoided Costs as listed in Tables 1b, 2b, and 3b and Renewable Avoided Costs as listed in Tables 4b, 5b, and 6b.

ON-PEAK PERIOD

The On-Peak period is 6:00 a.m. until 10:00 p.m., Monday through Saturday.

OFF-PEAK PERIOD

The Off-Peak period is 10:00 p.m. until 6:00 a.m., Monday through Saturday, and all day on Sunday.

Standard Avoided Costs are based on forward market price estimates through the Resource Sufficiency Period, the period of time during which the Company's Standard Avoided Costs are associated with incremental purchases of Energy and capacity from the market. For the Resource Deficiency Period, the Standard Avoided Costs reflect the fully allocated costs of a natural gas fueled combined cycle combustion turbine (CCCT) including fuel and capital costs. The CCCT Avoided Costs are based on the variable cost of Energy plus capitalized Energy costs at a 93% capacity factor based on a natural gas price forecast, with prices modified for shrinkage and transportation costs.

Renewable Avoided Costs are based on forward market price estimates through the Renewable Resource Sufficiency Period, the period of time during which the Company's Renewable Avoided Costs are associated with incremental purchases of energy and capacity from the market. For the Renewable Resource Deficiency Period, the Renewable Avoided Costs reflect the fully allocated costs of a wind plant including capital costs.

SCHEDULE 201 (Continued)**PRICING FOR STANDARD PPA**

Pricing represents the purchase price per MWh the Company will pay for electricity delivered to a Point of Delivery (POD) within the Company's service territory pursuant to a Standard PPA up to the nameplate rating of the QF in any hour. Any Energy delivered in excess of the nameplate rating will be purchased at the applicable Off-Peak Prices for the selected pricing option.

The Standard PPA pricing will be based on either the Standard or Renewable Avoided Costs in effect at the time the agreement is executed.

The Company will pay the Seller either the Off-Peak Standard Avoided Cost pursuant to Tables 1b, 2b, or 3b or the Off-Peak Renewable Avoided Costs pursuant to Tables 4b, 5b, or 6b for: (a) all Net Output delivered prior to the Commercial Operation Date; (b) all Net Output deliveries greater than Maximum Net Output in any PPA year; (c) any generation subject to and as adjusted by the provisions of Section 4.3 of the Standard PPA; (d) Net Output delivered in the Off-Peak Period; and (e) deliveries above the nameplate capacity in any hour. The Company will pay the Seller either the On-Peak Standard Avoided Cost pursuant to Tables 1a, 2a, or 3a or the On-Peak Renewable Avoided Costs pursuant to Tables 4a, 5a, or 6a for all other Net Output. (See the PPA for defined terms.)

1) Standard Fixed Price Option

The Standard Fixed Price Option is based on Standard Avoided Costs including forecasted natural gas prices. It is available to all QFs.

This option is available for a maximum term of 15 years. Prices will be as established at the time the Standard PPA is executed and will be equal to the Standard Avoided Costs in Tables 1a and 1b, 2a and 2b, or 3a and 3c, depending on the type of QF, effective at execution. QFs using any resource type other than wind and solar are assumed to be Base Load QFs.

Prices paid to the Seller under the Standard Fixed Price Option include adjustments for the capacity contribution of the QF resource type relative to that of the avoided proxy resource. Both the Base Load QF resources (Tables 1a and 1b) and the avoided proxy resource, the basis used to determine Standard Avoided Costs for the Standard Fixed Price Option, are assumed to have a capacity contribution to peak of 100%. The capacity contribution for Wind QF resources (Tables 2a and 2b) is assumed to be 18.59%. The capacity contribution for Solar QF resources (Tables 3a and 3b) is assumed to be 15.33%.

Prices paid to the Seller under the Standard Fixed Price Option for Wind QFs (Tables 2a and 2b) include a reduction for the wind integration costs in Table 7. However, if the Wind QF is outside of PGE's Balancing Authority Area as contemplated in the Commission's Order No. 14-058, the Seller is paid the wind integration charges in Table 7, in addition to the prices listed in Tables 2a and 2b, for a net-zero effect.

SCHEDULE 201 (Continued)

PRICING OPTIONS FOR STANDARD PPA (Continued)
Standard Fixed Price Option (Continued)

Sellers with terms exceeding 15 years from the commercial operation date will receive pricing equal to the Mid-C Index Price for all years up to five in excess of the initial 15 years after the commercial operation date selected by the Seller and memorialized in the PPA.

TABLE 1a												
Avoided Costs												
Standard Fixed Price Option for Base Load QF												
On-Peak Forecast (\$/MWH)												
Year	Jan	Feb	Mar	Apr	May	Jun	Jul	Aug	Sep	Oct	Nov	Dec
2017									29.46	26.91	27.42	33.53
2018	32.01	29.46	25.38	21.14	20.62	21.14	30.01	33.42	31.06	25.63	27.67	32.27
2019	31.18	29.49	23.89	19.25	18.62	19.53	30.14	34.47	31.43	26.91	28.93	34.34
2020	32.84	31.06	25.15	20.26	19.59	20.56	31.74	36.30	33.09	28.33	30.46	36.16
2021	51.02	50.79	50.36	48.10	48.02	48.20	48.41	48.59	48.62	48.82	49.46	50.45
2022	51.97	52.05	52.13	51.58	51.47	51.57	51.64	51.72	51.81	52.17	52.69	52.80
2023	54.83	54.92	55.02	54.47	54.32	54.41	54.49	54.59	54.68	54.81	55.50	55.59
2024	56.64	56.74	56.85	56.36	56.11	56.22	56.32	56.40	56.52	56.82	56.84	56.94
2025	58.30	58.42	58.51	57.80	57.77	57.69	57.79	57.88	58.00	58.10	58.84	58.94
2026	60.21	60.34	60.38	59.66	59.67	59.74	59.84	59.94	60.07	60.20	61.07	61.19
2027	62.07	62.20	62.10	61.37	61.50	61.25	61.36	61.46	61.58	62.33	60.98	61.11
2028	62.31	62.39	62.28	61.61	61.75	61.86	61.97	62.08	62.21	62.35	63.53	63.65
2029	65.14	65.27	65.39	64.69	64.87	65.99	66.11	66.23	66.39	66.51	67.85	67.99
2030	70.73	71.72	71.86	71.18	71.38	71.54	71.69	71.85	72.02	72.90	73.57	73.75
2031	75.45	75.64	75.25	74.15	74.30	74.19	74.33	74.49	74.67	74.84	76.00	76.17
2032	77.70	77.79	77.48	76.26	76.47	76.66	76.81	76.98	77.17	77.42	78.99	79.19
2033	81.27	81.47	81.22	80.06	80.29	80.49	80.66	80.84	81.05	81.46	82.88	83.09
2034	85.11	85.34	84.18	82.84	83.08	83.29	83.47	83.67	83.89	84.14	85.88	86.12
2035	87.98	88.22	87.07	85.69	85.94	85.61	85.80	86.00	86.24	86.74	88.22	88.67
2036	90.89	91.14	89.93	88.47	88.76	88.39	88.59	88.81	89.05	89.58	91.13	91.60
2037	94.20	94.46	93.20	91.67	91.95	91.57	91.78	92.00	92.25	92.83	94.45	94.96
2038	97.49	97.77	96.45	94.83	95.14	94.74	94.95	95.19	95.46	96.07	97.77	98.29
2039	100.95	101.22	99.84	98.14	98.46	98.04	98.27	98.52	98.80	99.44	101.22	101.78
2040	104.51	104.80	103.35	101.56	101.90	101.46	101.71	101.96	102.27	102.93	104.80	105.39
2041	108.28	108.59	107.05	105.17	105.51	105.07	105.32	105.59	105.90	106.61	108.58	109.19
2042	112.19	112.51	110.89	108.92	109.29	108.82	109.06	109.35	109.68	110.42	112.51	113.15

Effective for service
on and after September 18, 2017

SCHEDULE 201 (Continued)

PRICING OPTIONS FOR STANDARD PPA (Continued)
Standard Fixed Price Option (Continued)

TABLE 1b												
Avoided Costs												
Standard Fixed Price Option for Base Load QF												
Off-Peak Forecast (\$/MWH)												
Year	Jan	Feb	Mar	Apr	May	Jun	Jul	Aug	Sep	Oct	Nov	Dec
2017									24.72	23.85	24.11	27.42
2018	27.42	24.87	20.80	15.18	12.12	10.88	19.58	24.24	24.69	22.51	23.69	27.41
2019	24.42	24.61	19.29	13.46	10.42	10.07	19.15	25.06	25.53	23.33	24.87	29.38
2020	26.35	26.55	20.80	14.48	11.19	10.80	20.64	27.03	27.54	25.17	26.84	31.72
2021	23.46	23.23	22.79	20.54	20.46	20.64	20.85	21.02	21.05	21.25	21.90	22.88
2022	23.85	23.93	24.02	23.46	23.36	23.45	23.52	23.61	23.70	24.06	24.58	24.68
2023	26.06	26.16	26.25	25.71	25.55	25.64	25.73	25.82	25.92	26.04	26.73	26.83
2024	27.48	27.59	27.69	27.20	26.96	27.06	27.16	27.25	27.36	27.66	27.68	27.78
2025	28.47	28.59	28.68	27.97	27.93	27.86	27.96	28.04	28.16	28.26	29.00	29.11
2026	29.78	29.91	29.95	29.23	29.24	29.31	29.41	29.51	29.64	29.77	30.64	30.76
2027	31.03	31.16	31.07	30.33	30.46	30.22	30.32	30.42	30.54	31.29	29.94	30.07
2028	30.65	30.73	30.62	29.95	30.09	30.20	30.31	30.42	30.55	30.69	31.87	31.99
2029	32.84	32.97	33.09	32.40	32.57	33.69	33.81	33.94	34.09	34.21	35.56	35.70
2030	37.79	38.78	38.92	38.24	38.44	38.60	38.75	38.91	39.08	39.96	40.63	40.81
2031	41.85	42.04	41.66	40.55	40.70	40.59	40.74	40.90	41.07	41.24	42.41	42.58
2032	43.65	43.73	43.43	42.21	42.42	42.61	42.76	42.93	43.12	43.37	44.93	45.13
2033	46.31	46.52	46.26	45.10	45.33	45.54	45.70	45.88	46.10	46.51	47.92	48.14
2034	49.35	49.57	48.41	47.07	47.31	47.52	47.71	47.90	48.12	48.37	50.11	50.35
2035	51.61	51.85	50.71	49.32	49.58	49.25	49.43	49.63	49.87	50.37	51.85	52.30
2036	53.92	54.16	52.96	51.49	51.78	51.41	51.62	51.83	52.08	52.60	54.15	54.62
2037	56.36	56.62	55.37	53.83	54.11	53.74	53.94	54.17	54.41	54.99	56.61	57.12
2038	58.90	59.18	57.85	56.23	56.54	56.15	56.36	56.60	56.87	57.47	59.18	59.70
2039	61.58	61.85	60.47	58.78	59.09	58.68	58.91	59.15	59.44	60.07	61.85	62.41
2040	64.36	64.65	63.20	61.41	61.75	61.31	61.56	61.81	62.12	62.78	64.65	65.24
2041	67.32	67.64	66.10	64.21	64.56	64.11	64.36	64.63	64.95	65.65	67.62	68.24
2042	70.41	70.73	69.11	67.15	67.51	67.04	67.28	67.57	67.91	68.64	70.73	71.37

SCHEDULE 201 (Continued)

PRICING OPTIONS FOR STANDARD PPA (Continued)
 Standard Fixed Price Option (Continued)

TABLE 2a												
Avoided Costs												
Standard Fixed Price Option for Wind QF												
On-Peak Forecast (\$/MWH)												
Year	Jan	Feb	Mar	Apr	May	Jun	Jul	Aug	Sep	Oct	Nov	Dec
2017									28.61	26.06	26.57	32.68
2018	31.14	28.59	24.51	20.27	19.75	20.27	29.14	32.55	30.19	24.76	26.80	31.40
2019	30.30	28.61	23.01	18.37	17.74	18.65	29.26	33.59	30.55	26.03	28.05	33.46
2020	31.94	30.16	24.25	19.36	18.69	19.66	30.84	35.40	32.19	27.43	29.56	35.26
2021	36.32	36.09	35.66	33.41	33.32	33.51	33.72	33.89	33.92	34.12	34.76	35.75
2022	36.97	37.06	37.14	36.58	36.48	36.57	36.65	36.73	36.82	37.18	37.70	37.80
2023	39.49	39.58	39.68	39.13	38.98	39.07	39.16	39.25	39.34	39.47	40.16	40.25
2024	41.08	41.19	41.30	40.81	40.56	40.67	40.76	40.85	40.97	41.26	41.29	41.38
2025	42.39	42.51	42.60	41.89	41.86	41.78	41.88	41.96	42.08	42.18	42.92	43.03
2026	43.98	44.11	44.15	43.43	43.44	43.51	43.61	43.71	43.84	43.97	44.84	44.96
2027	45.52	45.64	45.55	44.81	44.95	44.70	44.80	44.90	45.03	45.78	44.43	44.55
2028	45.43	45.51	45.39	44.72	44.86	44.98	45.08	45.20	45.32	45.46	46.64	46.77
2029	47.92	48.05	48.16	47.47	47.65	48.77	48.88	49.01	49.17	49.28	50.63	50.77
2030	53.17	54.15	54.30	53.61	53.82	53.97	54.13	54.29	54.45	55.33	56.01	56.19
2031	57.54	57.72	57.34	56.24	56.38	56.27	56.42	56.58	56.75	56.92	58.09	58.26
2032	59.54	59.62	59.32	58.10	58.31	58.50	58.65	58.82	59.01	59.26	60.82	61.03
2033	62.63	62.83	62.58	61.41	61.64	61.85	62.01	62.19	62.41	62.82	64.24	64.45
2034	66.05	66.27	65.11	63.77	64.01	64.22	64.41	64.60	64.82	65.07	66.81	67.05
2035	68.59	68.83	67.68	66.30	66.56	66.22	66.41	66.61	66.85	67.35	68.83	69.28
2036	71.17	71.42	70.21	68.75	69.03	68.67	68.87	69.09	69.33	69.86	71.40	71.88
2037	74.03	74.29	73.03	71.50	71.77	71.40	71.61	71.83	72.08	72.66	74.27	74.79
2038	76.91	77.19	75.87	74.25	74.56	74.16	74.37	74.61	74.88	75.49	77.19	77.71
2039	79.96	80.23	78.85	77.16	77.47	77.06	77.29	77.53	77.82	78.45	80.23	80.79
2040	83.10	83.39	81.94	80.15	80.49	80.05	80.30	80.55	80.86	81.52	83.39	83.98
2041	86.44	86.75	85.21	83.33	83.67	83.22	83.48	83.75	84.06	84.76	86.74	87.35
2042	89.91	90.23	88.62	86.65	87.02	86.54	86.79	87.08	87.41	88.15	90.23	90.88

SCHEDULE 201 (Continued)

PRICING OPTIONS FOR STANDARD PPA (Continued)
 Standard Fixed Price Option (Continued)

TABLE 2b												
Avoided Costs												
Standard Fixed Price Option for Wind QF												
Off-Peak Forecast (\$/MWH)												
Year	Jan	Feb	Mar	Apr	May	Jun	Jul	Aug	Sep	Oct	Nov	Dec
2017									23.87	23.00	23.26	26.57
2018	26.55	24.00	19.93	14.31	11.25	10.01	18.71	23.37	23.82	21.64	22.82	26.54
2019	23.54	23.73	18.41	12.58	9.54	9.19	18.27	24.18	24.65	22.45	23.99	28.50
2020	25.45	25.65	19.90	13.58	10.29	9.90	19.74	26.13	26.64	24.27	25.94	30.82
2021	22.54	22.31	21.87	19.62	19.54	19.72	19.93	20.10	20.13	20.33	20.98	21.96
2022	22.91	22.99	23.08	22.52	22.42	22.51	22.58	22.67	22.76	23.12	23.64	23.74
2023	25.10	25.20	25.29	24.75	24.59	24.68	24.77	24.86	24.96	25.08	25.77	25.87
2024	26.50	26.61	26.71	26.22	25.98	26.08	26.18	26.27	26.38	26.68	26.70	26.80
2025	27.47	27.59	27.68	26.97	26.93	26.86	26.96	27.04	27.16	27.26	28.00	28.11
2026	28.76	28.89	28.93	28.21	28.22	28.29	28.39	28.49	28.62	28.75	29.62	29.74
2027	29.99	30.12	30.03	29.29	29.42	29.18	29.28	29.38	29.50	30.25	28.90	29.03
2028	29.59	29.67	29.56	28.89	29.03	29.14	29.25	29.36	29.49	29.63	30.81	30.93
2029	31.76	31.89	32.01	31.32	31.49	32.61	32.73	32.86	33.01	33.13	34.48	34.62
2030	36.69	37.68	37.82	37.14	37.34	37.50	37.65	37.81	37.98	38.86	39.53	39.71
2031	40.73	40.92	40.54	39.43	39.58	39.47	39.62	39.78	39.95	40.12	41.29	41.46
2032	42.51	42.59	42.29	41.07	41.28	41.47	41.62	41.79	41.98	42.23	43.79	43.99
2033	45.14	45.35	45.09	43.93	44.16	44.37	44.53	44.71	44.93	45.34	46.75	46.97
2034	48.16	48.38	47.22	45.88	46.12	46.33	46.52	46.71	46.93	47.18	48.92	49.16
2035	50.40	50.64	49.50	48.11	48.37	48.04	48.22	48.42	48.66	49.16	50.64	51.09
2036	52.68	52.92	51.72	50.25	50.54	50.17	50.38	50.59	50.84	51.36	52.91	53.38
2037	55.10	55.36	54.11	52.57	52.85	52.48	52.68	52.91	53.15	53.73	55.35	55.86
2038	57.61	57.89	56.56	54.94	55.25	54.86	55.07	55.31	55.58	56.18	57.89	58.41
2039	60.27	60.54	59.16	57.47	57.78	57.37	57.60	57.84	58.13	58.76	60.54	61.10
2040	63.02	63.31	61.86	60.07	60.41	59.97	60.22	60.47	60.78	61.44	63.31	63.90
2041	65.95	66.27	64.73	62.84	63.19	62.74	62.99	63.26	63.58	64.28	66.25	66.87
2042	69.02	69.34	67.72	65.76	66.12	65.65	65.89	66.18	66.52	67.25	69.34	69.98

SCHEDULE 201 (Continued)

PRICING OPTIONS FOR STANDARD PPA (Continued)
Standard Fixed Price Option (Continued)

TABLE 3a												
Avoided Costs												
Standard Fixed Price Option for Solar QF												
On-Peak Forecast (\$/MWH)												
Year	Jan	Feb	Mar	Apr	May	Jun	Jul	Aug	Sep	Oct	Nov	Dec
2017									29.46	26.91	27.42	33.53
2018	32.01	29.46	25.38	21.14	20.62	21.14	30.01	33.42	31.06	25.63	27.67	32.27
2019	31.18	29.49	23.89	19.25	18.62	19.53	30.14	34.47	31.43	26.91	28.93	34.34
2020	32.84	31.06	25.15	20.26	19.59	20.56	31.74	36.30	33.09	28.33	30.46	36.16
2021	34.71	34.48	34.04	31.79	31.71	31.89	32.10	32.27	32.30	32.51	33.15	34.14
2022	35.33	35.41	35.49	34.94	34.84	34.93	35.00	35.08	35.17	35.53	36.06	36.16
2023	37.81	37.90	37.99	37.45	37.29	37.39	37.47	37.56	37.66	37.78	38.48	38.57
2024	39.38	39.49	39.60	39.10	38.86	38.97	39.06	39.15	39.26	39.56	39.59	39.68
2025	40.65	40.77	40.85	40.15	40.11	40.04	40.13	40.22	40.34	40.44	41.18	41.29
2026	42.21	42.33	42.37	41.65	41.66	41.73	41.83	41.93	42.06	42.19	43.06	43.18
2027	43.70	43.83	43.74	43.00	43.13	42.89	42.99	43.09	43.21	43.96	42.61	42.74
2028	43.58	43.66	43.54	42.87	43.01	43.13	43.23	43.34	43.47	43.61	44.79	44.92
2029	46.03	46.16	46.27	45.58	45.76	46.88	46.99	47.12	47.28	47.39	48.74	48.88
2030	51.24	52.22	52.37	51.68	51.89	52.04	52.20	52.36	52.53	53.40	54.08	54.26
2031	55.57	55.75	55.37	54.27	54.41	54.30	54.45	54.61	54.78	54.95	56.12	56.29
2032	57.55	57.63	57.33	56.11	56.32	56.51	56.66	56.83	57.02	57.27	58.83	59.03
2033	60.58	60.79	60.53	59.37	59.60	59.80	59.97	60.15	60.37	60.77	62.19	62.41
2034	63.95	64.17	63.01	61.67	61.92	62.12	62.31	62.50	62.72	62.97	64.71	64.95
2035	66.45	66.69	65.55	64.17	64.42	64.09	64.28	64.48	64.71	65.22	66.69	67.14
2036	69.01	69.26	68.05	66.59	66.87	66.51	66.71	66.93	67.17	67.70	69.24	69.72
2037	71.81	72.07	70.81	69.28	69.56	69.18	69.39	69.61	69.86	70.44	72.06	72.57
2038	74.65	74.93	73.61	71.99	72.30	71.90	72.11	72.35	72.62	73.23	74.93	75.45
2039	77.65	77.92	76.54	74.85	75.16	74.75	74.98	75.22	75.51	76.14	77.92	78.48
2040	80.75	81.04	79.59	77.80	78.14	77.70	77.95	78.20	78.51	79.17	81.04	81.63
2041	84.04	84.36	82.82	80.93	81.28	80.83	81.08	81.35	81.66	82.37	84.34	84.95
2042	87.46	87.78	86.17	84.20	84.57	84.09	84.34	84.63	84.96	85.69	87.78	88.42

Effective for service
on and after September 18, 2017

SCHEDULE 201 (Continued)

PRICING OPTIONS FOR STANDARD PPA (Continued)
 Standard Fixed Price Option (Continued)

TABLE 3b												
Avoided Costs												
Standard Fixed Price Option for Solar QF												
Off-Peak Forecast (\$/MWH)												
Year	Jan	Feb	Mar	Apr	May	Jun	Jul	Aug	Sep	Oct	Nov	Dec
2017									24.72	23.85	24.11	27.42
2018	27.42	24.87	20.80	15.18	12.12	10.88	19.58	24.24	24.69	22.51	23.69	27.41
2019	24.42	24.61	19.29	13.46	10.42	10.07	19.15	25.06	25.53	23.33	24.87	29.38
2020	26.35	26.55	20.80	14.48	11.19	10.80	20.64	27.03	27.54	25.17	26.84	31.72
2021	23.46	23.23	22.79	20.54	20.46	20.64	20.85	21.02	21.05	21.25	21.90	22.88
2022	23.85	23.93	24.02	23.46	23.36	23.45	23.52	23.61	23.70	24.06	24.58	24.68
2023	26.06	26.16	26.25	25.71	25.55	25.64	25.73	25.82	25.92	26.04	26.73	26.83
2024	27.48	27.59	27.69	27.20	26.96	27.06	27.16	27.25	27.36	27.66	27.68	27.78
2025	28.47	28.59	28.68	27.97	27.93	27.86	27.96	28.04	28.16	28.26	29.00	29.11
2026	29.78	29.91	29.95	29.23	29.24	29.31	29.41	29.51	29.64	29.77	30.64	30.76
2027	31.03	31.16	31.07	30.33	30.46	30.22	30.32	30.42	30.54	31.29	29.94	30.07
2028	30.65	30.73	30.62	29.95	30.09	30.20	30.31	30.42	30.55	30.69	31.87	31.99
2029	32.84	32.97	33.09	32.40	32.57	33.69	33.81	33.94	34.09	34.21	35.56	35.70
2030	37.79	38.78	38.92	38.24	38.44	38.60	38.75	38.91	39.08	39.96	40.63	40.81
2031	41.85	42.04	41.66	40.55	40.70	40.59	40.74	40.90	41.07	41.24	42.41	42.58
2032	43.65	43.73	43.43	42.21	42.42	42.61	42.76	42.93	43.12	43.37	44.93	45.13
2033	46.31	46.52	46.26	45.10	45.33	45.54	45.70	45.88	46.10	46.51	47.92	48.14
2034	49.35	49.57	48.41	47.07	47.31	47.52	47.71	47.90	48.12	48.37	50.11	50.35
2035	51.61	51.85	50.71	49.32	49.58	49.25	49.43	49.63	49.87	50.37	51.85	52.30
2036	53.92	54.16	52.96	51.49	51.78	51.41	51.62	51.83	52.08	52.60	54.15	54.62
2037	56.36	56.62	55.37	53.83	54.11	53.74	53.94	54.17	54.41	54.99	56.61	57.12
2038	58.90	59.18	57.85	56.23	56.54	56.15	56.36	56.60	56.87	57.47	59.18	59.70
2039	61.58	61.85	60.47	58.78	59.09	58.68	58.91	59.15	59.44	60.07	61.85	62.41
2040	64.36	64.65	63.20	61.41	61.75	61.31	61.56	61.81	62.12	62.78	64.65	65.24
2041	67.32	67.64	66.10	64.21	64.56	64.11	64.36	64.63	64.95	65.65	67.62	68.24
2042	70.41	70.73	69.11	67.15	67.51	67.04	67.28	67.57	67.91	68.64	70.73	71.37

SCHEDULE 201 (Continued)

PRICING OPTIONS FOR STANDARD PPA (Continued)

2) Renewable Fixed Price Option

The Renewable Fixed Price Option is based on Renewable Avoided Costs. It is available only to Renewable QFs that generate electricity from a renewable energy source that may be used by the Company to comply with the Oregon Renewable Portfolio Standard as set forth in ORS 469A.005 to 469A.210.

This option is available for a maximum term of 15 years. Prices will be as established at the time the Standard PPA is executed and will be equal to the Renewable Avoided Costs in Tables 4a and 4b, 5a and 5b, or 6a and 6b, depending on the type of QF, effective at execution. QFs using any resource type other than wind and solar are assumed to be Base Load QFs.

Sellers will retain all Environmental Attributes generated by the facility during the Renewable Resource Sufficiency Period. A Renewable QF choosing the Renewable Fixed Price Option must cede all RPS Attributes generated by the facility to the Company from the start of the Renewable Resource Deficiency Period through the remainder of the PPA term.

Prices paid to the Seller under the Renewable Fixed Price Option include adjustments for the capacity contribution of the QF resource type relative to that of the avoided proxy resource. Both Wind QF resources (Tables 5a and 5b) and the avoided proxy resource, the basis used to determine Renewable Avoided Costs for the Renewable Fixed Price Option, are assumed to have a capacity contribution to peak of 18.59%. The capacity contribution for Solar QF resources (Tables 6a and 6b) is assumed to be 15.33%. The capacity contribution for Base Load QF resources (Tables 4a and 4b) is assumed to be 100%.

The Renewable Avoided Costs during the Renewable Resource Deficiency Period reflect an increase for avoided wind integration costs, shown in Table 7.

Prices paid to the Seller under the Renewable Fixed Price Option for Wind QFs (Tables 5a and 5b) include a reduction for the wind integration costs in Table 7, which cancels out wind integration costs included in the Renewable Avoided Costs during the Renewable Resource Deficiency Period. However, if the Wind QF is outside of PGE's Balancing Authority Area as contemplated in the Commission's Order No. 14-058, the Seller is paid the wind integration charges in Table 7, in addition to the prices listed in Tables 5a and 5b.

Sellers with terms exceeding 15 years from the commercial operation date will receive pricing equal to the Mid-C Index Price for all years up to five in excess of the initial 15 years following the commercial operation date selected by the Seller and memorialized in the PPA.

SCHEDULE 201 (Continued)

PRICING OPTIONS FOR STANDARD PPA (Continued)

Renewable Fixed Price Option (Continued)

TABLE 4a												
Renewable Avoided Costs												
Renewable Fixed Price Option for Base Load QF												
On-Peak Forecast (\$/MWH)												
Year	Jan	Feb	Mar	Apr	May	Jun	Jul	Aug	Sep	Oct	Nov	Dec
2017								34.81	29.46	26.91	27.42	33.53
2018	32.01	29.46	25.38	21.14	20.62	21.14	30.01	33.42	31.06	25.63	27.67	32.27
2019	31.18	29.49	23.89	19.25	18.62	19.53	30.14	34.47	31.43	26.91	28.93	34.34
2020	32.84	31.06	25.15	20.26	19.59	20.56	31.74	36.30	33.09	28.33	30.46	36.16
2021	34.60	32.72	26.46	21.28	20.58	21.61	33.44	38.27	34.87	29.82	32.09	38.13
2022	36.47	34.48	27.88	22.42	21.68	22.76	35.25	40.34	36.75	31.44	33.81	40.19
2023	32.55	32.48	28.51	25.11	23.14	21.85	28.29	31.03	33.38	33.87	34.01	36.07
2024	36.16	34.47	31.84	26.04	23.28	16.27	29.02	32.72	35.73	35.93	36.83	39.19
2025	121.49	116.85	109.64	93.72	86.14	66.90	101.89	112.05	120.31	120.85	123.32	129.80
2026	123.92	119.19	111.83	95.59	87.87	68.24	103.93	114.29	122.72	123.27	125.78	132.40
2027	126.40	121.57	114.07	97.50	89.63	69.60	106.01	116.58	125.17	125.74	128.30	135.05
2028	128.66	123.75	116.12	99.27	91.25	70.89	107.92	118.67	127.41	127.99	130.60	137.46
2029	131.50	126.48	118.67	101.44	93.25	72.42	110.29	121.29	130.23	130.82	133.48	140.50
2030	134.13	129.01	121.05	103.47	95.11	73.86	112.50	123.71	132.83	133.43	136.15	143.31
2031	136.82	131.59	123.47	105.54	97.01	75.34	114.75	126.19	135.49	136.10	138.88	146.18
2032	139.05	133.73	125.47	107.23	98.56	76.51	116.60	128.24	137.70	138.32	141.14	148.57
2033	142.34	136.91	128.46	109.81	100.93	78.39	119.38	131.29	140.96	141.60	144.49	152.09
2034	145.31	139.76	131.14	112.12	103.07	80.07	121.88	134.03	143.90	144.55	147.49	155.24
2035	148.09	142.44	133.65	114.24	105.01	81.55	124.20	136.59	146.66	147.32	150.32	158.23
2036	150.63	144.87	135.93	116.19	106.80	82.94	126.33	138.92	149.17	149.84	152.90	160.94
2037	154.08	148.19	139.05	118.86	109.25	84.85	129.22	142.11	152.58	153.27	156.40	164.62
2038	157.16	151.16	141.83	121.23	111.44	86.54	131.81	144.95	155.64	156.34	159.53	167.92
2039	160.30	154.18	144.66	123.66	113.67	88.27	134.44	147.85	158.75	159.46	162.72	171.27
2040	163.17	156.94	147.26	125.90	115.73	89.90	136.87	150.50	161.59	162.32	165.63	174.33
2041	166.78	160.41	150.51	128.65	118.26	91.84	139.87	153.82	165.16	165.91	169.29	178.19
2042	170.11	163.62	153.52	131.23	120.62	93.68	142.67	156.90	168.47	169.23	172.68	181.76

SCHEDULE 201 (Continued)

PRICING OPTIONS FOR STANDARD PPA (Continued)

Renewable Fixed Price Option (Continued)

TABLE 4b												
Renewable Avoided Costs												
Renewable Fixed Price Option for Base Load QF												
Off-Peak Forecast (\$/MWH)												
Year	Jan	Feb	Mar	Apr	May	Jun	Jul	Aug	Sep	Oct	Nov	Dec
2017								24.51	24.72	23.85	24.11	27.42
2018	27.42	24.87	20.80	15.18	12.12	10.88	19.58	24.24	24.69	22.51	23.69	27.41
2019	24.42	24.61	19.29	13.46	10.42	10.07	19.15	25.06	25.53	23.33	24.87	29.38
2020	26.35	26.55	20.80	14.48	11.19	10.80	20.64	27.03	27.54	25.17	26.84	31.72
2021	28.18	28.40	22.20	15.39	11.85	11.44	22.03	28.92	29.47	26.90	28.71	33.97
2022	30.11	30.34	23.71	16.42	12.61	12.18	23.53	30.91	31.50	28.75	30.68	36.32
2023	30.45	29.46	27.13	22.78	21.22	19.28	25.24	28.22	30.91	31.13	31.55	32.77
2024	32.49	29.95	29.34	24.83	21.55	13.81	25.44	29.61	32.06	32.27	34.41	35.80
2025	81.58	74.61	72.92	60.56	51.54	30.31	62.23	73.68	80.39	80.99	86.85	90.67
2026	83.22	76.10	74.38	61.77	52.57	30.91	63.48	75.16	81.99	82.61	88.59	92.49
2027	84.88	77.62	75.87	63.00	53.63	31.53	64.75	76.66	83.63	84.26	90.36	94.34
2028	86.34	78.96	77.17	64.09	54.55	32.07	65.86	77.98	85.07	85.71	91.92	95.96
2029	88.31	80.76	78.93	65.55	55.79	32.80	67.36	79.76	87.01	87.66	94.01	98.15
2030	90.08	82.37	80.51	66.86	56.91	33.46	68.71	81.35	88.75	89.41	95.89	100.11
2031	91.88	84.02	82.12	68.20	58.05	34.13	70.08	82.98	90.53	91.20	97.81	102.11
2032	93.46	85.47	83.53	69.37	59.04	34.72	71.29	84.41	92.09	92.77	99.49	103.87
2033	95.59	87.42	85.44	70.95	60.39	35.51	72.91	86.33	94.19	94.89	101.76	106.24
2034	97.50	89.16	87.15	72.37	61.60	36.22	74.37	88.06	96.07	96.79	103.80	108.36
2035	99.45	90.95	88.89	73.82	62.83	36.94	75.86	89.82	97.99	98.72	105.87	110.53
2036	101.16	92.51	90.42	75.09	63.91	37.58	77.17	91.37	99.68	100.42	107.69	112.43
2037	103.47	94.62	92.48	76.80	65.37	38.44	78.92	93.45	101.95	102.71	110.15	115.00
2038	105.54	96.51	94.33	78.34	66.68	39.20	80.50	95.32	103.99	104.76	112.35	117.29
2039	107.65	98.45	96.22	79.90	68.01	39.99	82.11	97.23	106.07	106.86	114.60	119.64
2040	109.50	100.14	97.87	81.28	69.18	40.68	83.53	98.90	107.89	108.70	116.57	121.70
2041	112.00	102.42	100.10	83.13	70.76	41.60	85.43	101.15	110.35	111.18	119.23	124.47
2042	114.24	104.47	102.11	84.79	72.17	42.44	87.14	103.18	112.56	113.40	121.61	126.96

SCHEDULE 201 (Continued)

PRICING OPTIONS FOR STANDARD PPA (Continued)

Renewable Fixed Price Option (Continued)

TABLE 5a												
Renewable Avoided Costs												
Renewable Fixed Price Option for Wind QF												
On-Peak Forecast (\$/MWH)												
Year	Jan	Feb	Mar	Apr	May	Jun	Jul	Aug	Sep	Oct	Nov	Dec
2017								33.96	28.61	26.06	26.57	32.68
2018	31.14	28.59	24.51	20.27	19.75	20.27	29.14	32.55	30.19	24.76	26.80	31.40
2019	30.30	28.61	23.01	18.37	17.74	18.65	29.26	33.59	30.55	26.03	28.05	33.46
2020	31.94	30.16	24.25	19.36	18.69	19.66	30.84	35.40	32.19	27.43	29.56	35.26
2021	33.68	31.80	25.54	20.36	19.66	20.69	32.52	37.35	33.95	28.90	31.17	37.21
2022	35.53	33.54	26.94	21.48	20.74	21.82	34.31	39.40	35.81	30.50	32.87	39.25
2023	31.59	31.52	27.55	24.15	22.18	20.89	27.33	30.07	32.42	32.91	33.05	35.11
2024	35.18	33.49	30.86	25.06	22.30	15.29	28.04	31.74	34.75	34.95	35.85	38.21
2025	105.58	100.94	93.72	77.80	70.23	50.99	85.98	96.14	104.40	104.94	107.41	113.89
2026	107.69	102.95	95.60	79.36	71.64	52.01	87.70	98.06	106.49	107.04	109.55	116.17
2027	109.84	105.01	97.51	80.95	73.07	53.05	89.45	100.02	108.62	109.18	111.75	118.49
2028	111.77	106.86	99.23	82.38	74.37	54.00	91.03	101.79	110.53	111.10	113.71	120.57
2029	114.28	109.26	101.45	84.22	76.02	55.19	93.07	104.07	113.01	113.59	116.26	123.28
2030	116.57	111.45	103.48	85.91	77.55	56.30	94.93	106.15	115.27	115.87	118.59	125.75
2031	118.90	113.68	105.55	87.63	79.10	57.43	96.83	108.27	117.58	118.19	120.96	128.27
2032	120.89	115.57	107.31	89.07	80.40	58.35	98.44	110.07	119.54	120.16	122.98	130.41
2033	123.70	118.26	109.81	91.16	82.29	59.74	100.74	112.64	122.32	122.96	125.84	133.44
2034	126.24	120.69	112.07	93.05	84.00	61.00	102.81	114.96	124.83	125.48	128.42	136.17
2035	128.71	123.05	114.26	94.85	85.62	62.16	104.82	117.20	127.27	127.93	130.94	138.84
2036	130.90	125.15	116.21	96.47	87.08	63.22	106.60	119.20	129.44	130.12	133.17	141.21
2037	133.90	128.02	118.87	98.68	89.08	64.67	109.05	121.94	132.41	133.10	136.22	144.45
2038	136.58	130.58	121.24	100.65	90.86	65.96	111.23	124.37	135.05	135.76	138.94	147.33
2039	139.31	133.19	123.68	102.67	92.68	67.29	113.46	126.86	137.76	138.48	141.73	150.29
2040	141.76	135.53	125.85	104.49	94.32	68.49	115.46	129.09	140.18	140.91	144.22	152.92
2041	144.94	138.57	128.66	106.81	96.42	70.00	118.03	131.98	143.32	144.06	147.45	156.35
2042	147.84	141.35	131.25	108.96	98.35	71.41	120.40	134.63	146.19	146.95	150.40	159.49

SCHEDULE 201 (Continued)

PRICING OPTIONS FOR STANDARD PPA (Continued)
Renewable Fixed Price Option (Continued)

TABLE 5b												
Renewable Avoided Costs												
Renewable Fixed Price Option for Wind QF												
Off-Peak Forecast (\$/MWH)												
Year	Jan	Feb	Mar	Apr	May	Jun	Jul	Aug	Sep	Oct	Nov	Dec
2017								23.66	23.87	23.00	23.26	26.57
2018	26.55	24.00	19.93	14.31	11.25	10.01	18.71	23.37	23.82	21.64	22.82	26.54
2019	23.54	23.73	18.41	12.58	9.54	9.19	18.27	24.18	24.65	22.45	23.99	28.50
2020	25.45	25.65	19.90	13.58	10.29	9.90	19.74	26.13	26.64	24.27	25.94	30.82
2021	27.26	27.48	21.28	14.47	10.93	10.52	21.11	28.00	28.55	25.98	27.79	33.05
2022	29.17	29.40	22.77	15.48	11.67	11.24	22.59	29.97	30.56	27.81	29.74	35.38
2023	29.49	28.50	26.17	21.82	20.26	18.32	24.28	27.26	29.95	30.17	30.59	31.81
2024	31.51	28.97	28.36	23.85	20.57	12.83	24.46	28.63	31.08	31.29	33.43	34.82
2025	80.58	73.61	71.92	59.56	50.54	29.31	61.23	72.68	79.39	79.99	85.85	89.67
2026	82.20	75.08	73.36	60.75	51.55	29.89	62.46	74.14	80.97	81.59	87.57	91.47
2027	83.84	76.58	74.83	61.96	52.59	30.49	63.71	75.62	82.59	83.22	89.32	93.30
2028	85.28	77.90	76.11	63.03	53.49	31.01	64.80	76.92	84.01	84.65	90.86	94.90
2029	87.23	79.68	77.85	64.47	54.71	31.72	66.28	78.68	85.93	86.58	92.93	97.07
2030	88.98	81.27	79.41	65.76	55.81	32.36	67.61	80.25	87.65	88.31	94.79	99.01
2031	90.76	82.90	81.00	67.08	56.93	33.01	68.96	81.86	89.41	90.08	96.69	100.99
2032	92.32	84.33	82.39	68.23	57.90	33.58	70.15	83.27	90.95	91.63	98.35	102.73
2033	94.42	86.25	84.27	69.78	59.22	34.34	71.74	85.16	93.02	93.72	100.59	105.07
2034	96.31	87.97	85.96	71.18	60.41	35.03	73.18	86.87	94.88	95.60	102.61	107.17
2035	98.24	89.74	87.68	72.61	61.62	35.73	74.65	88.61	96.78	97.51	104.66	109.32
2036	99.92	91.27	89.18	73.85	62.67	36.34	75.93	90.13	98.44	99.18	106.45	111.19
2037	102.21	93.36	91.22	75.54	64.11	37.18	77.66	92.19	100.69	101.45	108.89	113.74
2038	104.25	95.22	93.04	77.05	65.39	37.91	79.21	94.03	102.70	103.47	111.06	116.00
2039	106.34	97.14	94.91	78.59	66.70	38.68	80.80	95.92	104.76	105.55	113.29	118.33
2040	108.16	98.80	96.53	79.94	67.84	39.34	82.19	97.56	106.55	107.36	115.23	120.36
2041	110.63	101.05	98.73	81.76	69.39	40.23	84.06	99.78	108.98	109.81	117.86	123.10
2042	112.85	103.08	100.72	83.40	70.78	41.05	85.75	101.79	111.17	112.01	120.22	125.57

Effective for service
on and after September 18, 2017

SCHEDULE 201 (Continued)

PRICING OPTIONS FOR STANDARD PPA (Continued)
Renewable Fixed Price Option (Continued)

TABLE 6a												
Renewable Avoided Costs												
Renewable Fixed Price Option for Solar QF												
On-Peak Forecast (\$/MWH)												
Year	Jan	Feb	Mar	Apr	May	Jun	Jul	Aug	Sep	Oct	Nov	Dec
2017								34.81	29.46	26.91	27.42	33.53
2018	32.01	29.46	25.38	21.14	20.62	21.14	30.01	33.42	31.06	25.63	27.67	32.27
2019	31.18	29.49	23.89	19.25	18.62	19.53	30.14	34.47	31.43	26.91	28.93	34.34
2020	32.84	31.06	25.15	20.26	19.59	20.56	31.74	36.30	33.09	28.33	30.46	36.16
2021	34.60	32.72	26.46	21.28	20.58	21.61	33.44	38.27	34.87	29.82	32.09	38.13
2022	36.47	34.48	27.88	22.42	21.68	22.76	35.25	40.34	36.75	31.44	33.81	40.19
2023	32.55	32.48	28.51	25.11	23.14	21.85	28.29	31.03	33.38	33.87	34.01	36.07
2024	36.16	34.47	31.84	26.04	23.28	16.27	29.02	32.72	35.73	35.93	36.83	39.19
2025	103.83	99.19	91.98	76.06	68.49	49.24	84.23	94.40	102.66	103.20	105.66	112.15
2026	105.91	101.18	93.82	77.58	69.86	50.23	85.92	96.28	104.71	105.26	107.78	114.39
2027	108.03	103.20	95.70	79.13	71.26	51.23	87.64	98.21	106.80	107.37	109.93	116.68
2028	109.92	105.01	97.38	80.53	72.52	52.15	89.18	99.93	108.68	109.25	111.86	118.72
2029	112.39	107.37	99.56	82.33	74.13	53.30	91.18	102.18	111.12	111.71	114.37	121.39
2030	114.64	109.52	101.55	83.98	75.62	54.37	93.00	104.22	113.34	113.94	116.66	123.82
2031	116.93	111.71	103.58	85.66	77.13	55.46	94.86	106.30	115.61	116.22	118.99	126.30
2032	118.89	113.58	105.32	87.08	78.41	56.36	96.44	108.08	117.55	118.17	120.99	128.42
2033	121.66	116.22	107.77	89.12	80.25	57.70	98.69	110.60	120.28	120.91	123.80	131.40
2034	124.14	118.59	109.97	90.95	81.90	58.90	100.72	112.86	122.73	123.38	126.32	134.07
2035	126.57	120.92	112.12	92.72	83.49	60.03	102.68	115.07	125.14	125.80	128.80	136.71
2036	128.74	122.99	114.05	94.31	84.92	61.06	104.44	117.04	127.28	127.96	131.01	139.05
2037	131.69	125.80	116.65	96.46	86.86	62.45	106.83	119.72	130.19	130.88	134.01	142.23
2038	134.32	128.32	118.99	98.39	88.60	63.70	108.97	122.11	132.80	133.50	136.69	145.08
2039	137.01	130.88	121.37	100.36	90.37	64.98	111.15	124.55	135.45	136.17	139.42	147.98
2040	139.41	133.18	123.50	102.13	91.97	66.14	113.10	126.74	137.83	138.56	141.86	150.57
2041	142.54	136.17	126.27	104.42	94.02	67.60	115.64	129.58	140.92	141.67	145.05	153.96
2042	145.39	138.89	128.79	106.50	95.90	68.95	117.95	132.18	143.74	144.50	147.95	157.03

Effective for service
on and after September 18, 2017

SCHEDULE 201 (Continued)

PRICING OPTIONS FOR STANDARD PPA (Continued)

Renewable Fixed Price Option (Continued)

TABLE 6b												
Renewable Avoided Costs												
Renewable Fixed Price Option for Solar QF												
Off-Peak Forecast (\$/MWH)												
Year	Jan	Feb	Mar	Apr	May	Jun	Jul	Aug	Sep	Oct	Nov	Dec
2017								24.51	24.72	23.85	24.11	27.42
2018	27.42	24.87	20.80	15.18	12.12	10.88	19.58	24.24	24.69	22.51	23.69	27.41
2019	24.42	24.61	19.29	13.46	10.42	10.07	19.15	25.06	25.53	23.33	24.87	29.38
2020	26.35	26.55	20.80	14.48	11.19	10.80	20.64	27.03	27.54	25.17	26.84	31.72
2021	28.18	28.40	22.20	15.39	11.85	11.44	22.03	28.92	29.47	26.90	28.71	33.97
2022	30.11	30.34	23.71	16.42	12.61	12.18	23.53	30.91	31.50	28.75	30.68	36.32
2023	30.45	29.46	27.13	22.78	21.22	19.28	25.24	28.22	30.91	31.13	31.55	32.77
2024	32.49	29.95	29.34	24.83	21.55	13.81	25.44	29.61	32.06	32.27	34.41	35.80
2025	81.58	74.61	72.92	60.56	51.54	30.31	62.23	73.68	80.39	80.99	86.85	90.67
2026	83.22	76.10	74.38	61.77	52.57	30.91	63.48	75.16	81.99	82.61	88.59	92.49
2027	84.88	77.62	75.87	63.00	53.63	31.53	64.75	76.66	83.63	84.26	90.36	94.34
2028	86.34	78.96	77.17	64.09	54.55	32.07	65.86	77.98	85.07	85.71	91.92	95.96
2029	88.31	80.76	78.93	65.55	55.79	32.80	67.36	79.76	87.01	87.66	94.01	98.15
2030	90.08	82.37	80.51	66.86	56.91	33.46	68.71	81.35	88.75	89.41	95.89	100.11
2031	91.88	84.02	82.12	68.20	58.05	34.13	70.08	82.98	90.53	91.20	97.81	102.11
2032	93.46	85.47	83.53	69.37	59.04	34.72	71.29	84.41	92.09	92.77	99.49	103.87
2033	95.59	87.42	85.44	70.95	60.39	35.51	72.91	86.33	94.19	94.89	101.76	106.24
2034	97.50	89.16	87.15	72.37	61.60	36.22	74.37	88.06	96.07	96.79	103.80	108.36
2035	99.45	90.95	88.89	73.82	62.83	36.94	75.86	89.82	97.99	98.72	105.87	110.53
2036	101.16	92.51	90.42	75.09	63.91	37.58	77.17	91.37	99.68	100.42	107.69	112.43
2037	103.47	94.62	92.48	76.80	65.37	38.44	78.92	93.45	101.95	102.71	110.15	115.00
2038	105.54	96.51	94.33	78.34	66.68	39.20	80.50	95.32	103.99	104.76	112.35	117.29
2039	107.65	98.45	96.22	79.90	68.01	39.99	82.11	97.23	106.07	106.86	114.60	119.64
2040	109.50	100.14	97.87	81.28	69.18	40.68	83.53	98.90	107.89	108.70	116.57	121.70
2041	112.00	102.42	100.10	83.13	70.76	41.60	85.43	101.15	110.35	111.18	119.23	124.47
2042	114.24	104.47	102.11	84.79	72.17	42.44	87.14	103.18	112.56	113.40	121.61	126.96

SCHEDULE 201 (Continued)

WIND INTEGRATION

TABLE 7	
Integration Costs	
Year	\$/MWh
2017	0.85
2018	0.87
2019	0.88
2020	0.90
2021	0.92
2022	0.94
2023	0.96
2024	0.98
2025	1.00
2026	1.02
2027	1.04
2028	1.06
2029	1.08
2030	1.10
2031	1.12
2032	1.14
2033	1.17
2034	1.19
2035	1.21
2036	1.24
2037	1.26
2038	1.29
2039	1.31
2040	1.34
2041	1.37
2042	1.39

SCHEDULE 201 (Continued)

MONTHLY SERVICE CHARGE

Each separately metered QF not associated with a retail Customer account will be charged \$10.00 per month.

INSURANCE REQUIREMENTS

The following insurance requirements are applicable to Sellers with a Standard PPA:

- 1) QFs with nameplate capacity ratings greater than 200 kW are required to secure and maintain a prudent amount of general liability insurance. The Seller must certify to the Company that it is maintaining general liability insurance coverage for each QF at prudent amounts. A prudent amount will be deemed to mean liability insurance coverage for both bodily injury and property damage liability in the amount of not less than \$1,000,000 each occurrence combined single limit, which limits may be required to be increased or decreased by the Company as the Company determines in its reasonable judgment, that economic conditions or claims experience may warrant.
- 2) Such insurance will include an endorsement naming the Company as an additional insured insofar as liability arising out of operations under this schedule and a provision that such liability policies will not be canceled or their limits reduced without 30 days' written notice to the Company. The Seller will furnish the Company with certificates of insurance together with the endorsements required herein. The Company will have the right to inspect the original policies of such insurance.
- 3) QFs with a design capacity of 200 kW or less are encouraged to pursue liability insurance on their own. The Oregon Public Utility Commission in Order No. 05-584 determined that it is inappropriate to require QFs that have a design capacity of 200 kW or less to obtain general liability insurance.

TRANSMISSION AGREEMENTS

If the QF is located outside the Company's service territory, the Seller is responsible for the transmission of power at its cost to the Company's service territory.

INTERCONNECTION REQUIREMENTS

Except as otherwise provided in a generation Interconnection Agreement between the Company and Seller, if the QF is located within the Company's service territory, switching equipment capable of isolating the QF from the Company's system will be accessible to the Company at all times. At the Company's option, the Company may operate the switching equipment described above if, in the sole opinion of the Company, continued operation of the QF in connection with the utility's system may create or contribute to a system emergency.

SCHEDULE 201 (Continued)**INTERCONNECTION REQUIREMENTS (Continued)**

The QF owner interconnecting with the Company's distribution system must comply with all requirements for interconnection as established pursuant to Commission rule, in the Company's Rules and Regulations (Rule C) or the Company's Interconnection Procedures contained in its FERC Open Access Transmission Tariff (OATT), as applicable. The Seller will bear full responsibility for the installation and safe operation of the interconnection facilities.

DEFINITION OF A SMALL COGENERATION FACILITY OR SMALL POWER PRODUCTION FACILITY ELIGIBLE TO RECEIVE PRICING UNDER THE STANDARD PPA

A QF will be eligible to receive pricing under the Standard PPA if the nameplate capacity of the QF, together with any other electric generating facility using the same motive force, owned or controlled by the Same Person(s) or Affiliated Person(s), and located at the Same Site, does not exceed 10 MW. A Community-Based or Family-Owned QF is exempt from these restrictions.

Definition of Community-Based

- a. A community project (or a community sponsored project) must have a recognized and established organization located within the county of the project or within 50 miles of the project that has a genuine role in helping the project be developed and must have some not insignificant continuing role with or interest in the project after it is completed and placed in service.
- b. After excluding the passive investor whose ownership interests are primarily related to green tag values and tax benefits as the primary ownership benefit, the equity (ownership) interests in a community sponsored project must be owned in substantial percentage (80 percent or more) by the following persons (individuals and entities): (i) the sponsoring organization, or its controlled affiliates; (ii) members of the sponsoring organization (if it is a membership organization) or owners of the sponsorship organization (if it is privately owned); (iii) persons who live in the county in which the project is located or who live a county adjoining the county in which the project is located; or (iv) units of local government, charities, or other established nonprofit organizations active either in the county in which the project is located or active in a county adjoining the county in which the project is located.

Definition of Family-Owned

After excluding the ownership interest of the passive investor whose ownership interests are primarily related to green tag values and tax benefits as the primary ownership benefit, five or fewer individuals own 50 percent or more of the equity of the project entity, or fifteen or fewer individuals own 90 percent or more of the project entity. A "look through" rule applies to closely held entities that hold the project entity, so that equity held by LLCs, trusts, estates, corporations, partnerships or other similar entities is considered held by the equity owners of the look through entity. An individual is a natural person. In counting to five or fifteen, spouses or children of an equity owner of the project owner who also have an equity interest are aggregated and counted as a single individual.

SCHEDULE 201 (Continued)**DEFINITION OF A SMALL COGENERATION FACILITY OR SMALL POWER PRODUCTION FACILITY ELIGIBLE TO RECEIVE PRICING UNDER THE STANDARD PPA (Continued)****Definition of Person(s) or Affiliated Person(s)**

As used above, the term "Same Person(s)" or "Affiliated Person(s)" means a natural person or persons or any legal entity or entities sharing common ownership, management or acting jointly or in concert with or exercising influence over the policies or actions of another person or entity. However, two facilities will not be held to be owned or controlled by the Same Person(s) or Affiliated Person(s) solely because they are developed by a single entity.

Furthermore, two facilities will not be held to be owned or controlled by the Same Person(s) or Affiliated Person(s) if such common person or persons is a "passive investor" whose ownership interest in the QF is primarily related to utilizing production tax credits, green tag values and MACRS depreciation as the primary ownership benefit and the facilities at issue are independent family-owned or community-based projects. A unit of Oregon local government may also be a "passive investor" in a community-based project if the local governmental unit demonstrates that it will not have an equity ownership interest in or exercise any control over the management of the QF and that its only interest is a share of the cash flow from the QF, which share will not exceed 20%. The 20% cash flow share limit may only be exceeded for good cause shown and only with the prior approval of the Commission.

Definition of Same Site

For purposes of the foregoing, generating facilities are considered to be located at the same site as the QF for which qualification for pricing under the Standard PPA is sought if they are located within a five-mile radius of any generating facilities or equipment providing fuel or motive force associated with the QF for which qualification for pricing under the Standard PPA is sought.

Definition of Shared Interconnection and Infrastructure

QFs otherwise meeting the above-described separate ownership test and thereby qualified for entitlement to pricing under the Standard PPA will not be disqualified by utilizing an interconnection or other infrastructure not providing motive force or fuel that is shared with other QFs qualifying for pricing under the Standard PPA so long as the use of the shared interconnection complies with the interconnecting utility's safety and reliability standards, interconnection agreement requirements and Prudent Electrical Practices as that term is defined in the interconnecting utility's approved Standard PPA.

OTHER DEFINITIONS**Mid-C Index Price**

As used in this schedule, the daily Mid-C Index Price shall be the Day Ahead Intercontinental Exchange ("ICE") for the bilateral OTC market for energy at the Mid-C Physical for Average

SCHEDULE 201 (Continued)

OTHER DEFINITIONS (Continued)

On-Peak Power and Average Off-Peak Power found on the following website: <https://www.theice.com/products/OTC/Physical-Energy/Electricity>. In the event ICE no longer publishes this index, PGE and the Seller agree to select an alternative successor index representative of the Mid-C trading hub.

Definition of RPS Attributes

As used in this schedule, RPS Attributes means all attributes related to the Net Output generated by the Facility that are required in order to provide PGE with “qualifying electricity,” as that term is defined in Oregon’s Renewable Portfolio Standard Act, Ore. Rev. Stat. 469A.010, in effect at the time of execution of this Agreement. RPS Attributes do not include Environmental Attributes that are greenhouse gas offsets from methane capture not associated with the generation of electricity and not needed to ensure that there are zero net emissions associated with the generation of electricity.

Definition of Environmental Attributes

As used in this schedule, Environmental Attributes shall mean any and all claims, credits, benefits, emissions reductions, offsets, and allowances, howsoever entitled, resulting from the avoidance of the emission of any gas, chemical, or other substance to the air, soil or water. Environmental Attributes include but are not limited to: (1) any avoided emissions of pollutants to the air, soil, or water such as (subject to the foregoing) sulfur oxides (SOx), nitrogen oxides (NOx), carbon monoxide (CO), and other pollutants; and (2) any avoided emissions of carbon dioxide (CO₂), methane (CH₄), and other greenhouse gases (GHGs) that have been determined by the United Nations Intergovernmental Panel on Climate Change to contribute to the actual or potential threat of altering the Earth’s climate by trapping heat in the atmosphere.

Definition of Resource Sufficiency Period

This is the period from the current year through 2020.

Definition of Resource Deficiency Period

This is the period from 2021.

Definition of Renewable Resource Sufficiency Period

This is the period from the current year through 2024.

Definition of Renewable Resource Deficiency Period

This is the period from 2025.

SCHEDULE 201 (Concluded)

DISPUTE RESOLUTION

Upon request, the QF will provide the purchasing utility with documentation verifying the ownership, management and financial structure of the QF in reasonably sufficient detail to allow the utility to make an initial determination of whether or not the QF meets the above-described criteria for entitlement to pricing under the Standard PPA.

The QF may present disputes to the Commission for resolution using the following process:

The QF may file a complaint asking the Commission to adjudicate disputes regarding the formation of the standard contract. The QF may not file such a complaint during any 15-day period in which the utility has the obligation to respond, but must wait until the 15-day period has passed.

The utility may respond to the complaint within ten days of service.

The Commission will limit its review to the issues identified in the complaint and response, and utilize a process similar to the arbitration process adopted to facilitate the execution of interconnection agreements among telecommunications carriers. See OAR 860, Division 016. The administrative law judge will not act as an arbitrator.

SPECIAL CONDITIONS

1. Delivery of energy by Seller will be at a voltage, phase, frequency, and power factor as specified by the Company.
2. If the Seller also receives retail Electricity Service from the Company at the same location, any payments under this schedule will be credited to the Seller's retail Electricity Service bill. At the option of the Customer, any net credit over \$10.00 will be paid by check to the Customer.
3. Unless required by state or federal law, if the 1978 Public Utility Regulatory Policies Act (PURPA) is repealed, PPAs entered into pursuant to this schedule will not terminate prior to the Standard or Negotiated PPA's termination date.

TERM OF AGREEMENT

Not less than one year and not to exceed 20 years from the commercial operation date selected by the Seller and memorialized in the PPA.