



e-FILING REPORT COVER SHEET

COMPANY NAME: PacifiCorp dba Pacific Power

DOES REPORT CONTAIN CONFIDENTIAL INFORMATION? No Yes If yes, submit a redacted public version (or a cover letter) by email. Submit the confidential information as directed in OAR 860-001-0070 or the terms of an applicable protective order.

Select report type: RE (Electric) RG (Gas) RW (Water) RT (Telecommunications)
 RO (Other, for example, industry safety information)

Did you previously file a similar report? No Yes, report docket number:

Report is required by: OAR 860-029-0030(7)

Statute

Order

Note: A one-time submission required by an order is a compliance filing and not a report (file compliance in the applicable docket)

Other

(For example, federal regulations, or requested by Staff)

Is this report associated with a specific docket/case? No Yes, docket number:

List Key Words for this report. We use these to improve search results.

QF PPA, PURPA, CSP

Send the completed Cover Sheet and the Report in an email addressed to PUC.FilingCenter@state.or.us

Send confidential information, voluminous reports, or energy utility Results of Operations Reports to PUC Filing Center, PO Box 1088, Salem, OR 97308-1088 or by delivery service to 201 High Street SE Suite 100, Salem, OR 97301.

November 9, 2023

VIA ELECTRONIC FILING

Public Utility Commission of Oregon
Attn: Filing Center
201 High Street SE, Suite 100
Salem, OR 97301-1166

**RE: RE 142 - Informational Filing on Qualifying Facility Transactions
Community Solar Program Purchase Agreement**

In accordance with Oregon Administrative Rules (OAR) 860-029-0030(7), PacifiCorp d/b/a Pacific Power (PacifiCorp) submits electronic copies of an executed Community Solar Program (CSP) purchase agreement (PA), as listed on Attachment A.

In accordance with OAR 860-088-0140(1)(a), a CSP PA is subject to the requirements of the Public Utility Regulatory Policies Act of 1978 (PURPA). PacifiCorp's Schedule 126 requires that a project seeking a CSP PA be "Certified or exempt from certification as a Qualifying Facility under PURPA".

If you have any questions, please contact Cathie Allen at (503) 813-5934.

Sincerely,



Matthew McVee
Vice President, Regulatory Policy and Operations

Enclosures

cc: Paul Rossow, OPUC staff

RE 142
Informational Filing

Community Solar Program
Purchase Agreement

November 9, 2023

Attachment A

<p>Oregon Community Solar Program Purchase Agreements ** NON-CONFIDENTIAL **</p>
--

<p>Green Solar LLC</p>

COMMUNITY SOLAR PROGRAM PURCHASE AGREEMENT

THIS COMMUNITY SOLAR PROGRAM PURCHASE AGREEMENT (the “Agreement”) entered into this 3rd day of November, 2023 (the “Effective Date”), is between Green Solar LLC, an Oregon Limited Liability Company (“Project Manager”), and PacifiCorp, an Oregon corporation acting in its regulated utility capacity (“PacifiCorp”). Project Manager and PacifiCorp are referred to individually in this Agreement as a “Party” and collectively as the “Parties.”

RECITALS

A. Project Manager intends to operate a solar photovoltaic facility for the generation of electric power, including interconnection facilities, located in Culver, Oregon with a facility capacity rating of 2,875 kilowatts (kW) as further described in Exhibit A and Exhibit B (“Facility”); and

B. Project Manager intends to commence delivery of Start-up Test Energy under this Agreement on October 30, 2023; and

C. Project Manager intends to operate the Facility as a Community Solar Program Project, commencing commercial operations on November 30, 2023 (“Scheduled Commercial Operation Date”).

D. Project Manager estimates that the average annual Net Output to be delivered by the Facility to PacifiCorp is 6,166,913 kilowatt-hours (kWh); and

E. This Agreement is a Community Solar Program Purchase Agreement under the Oregon Community Solar Program implemented by the Oregon Public Utility Commission pursuant to ORS 757.386(2).

AGREEMENT

NOW, THEREFORE, the Parties mutually agree as follows:

SECTION 1: DEFINITIONS

When used in this Agreement, the following terms shall have the following meanings:

Agreement means this Community Solar Program Purchase Agreement.

As-Available Rate is the rate at which PacifiCorp will purchase a Project’s Unsubscribed Energy. The As-Available Rate will be calculated using the Non-Firm Market Price Index.

Average Annual Generation has the meaning stated in Section 5.6.

Certified Project is a Community Solar Program Project that has been certified by the Oregon Public Utility Commission under OAR 860-088-0050 and in accordance with the Program Implementation Manual.

Commercial Operation Date means the date that the Facility is deemed by PacifiCorp to be fully operational and reliable, which requires, among other things, that all of the following events have occurred:

1. Project Manager provides evidence that the Facility is a Certified Project.

2. PacifiCorp has received a certificate addressed to PacifiCorp from a Licensed Professional Engineer stating (a) the facility capacity rating of the Facility at the anticipated Commercial Operation Date; (b) that the Facility is able to generate electric power reliably in amounts required by this Agreement and in accordance with all other terms and conditions of this Agreement; (c) the Facility has completed start-up testing and commissioning; and (d) in accordance with the Generation Interconnection Agreement, all required interconnection facilities have been constructed, all required interconnection tests have been completed, and the Facility is physically interconnected with PacifiCorp's electric system;
3. PacifiCorp has received a certificate addressed to PacifiCorp from an officer of Project Manager stating that Project Manager has obtained all Required Project Documents and, if requested by PacifiCorp in writing, has provided copies of any or all such requested Required Project Documents; and
4. PacifiCorp has received an executed copy of Exhibit E—Project Manager's Authorization to Release Generation Data to PacifiCorp.

Community Solar Program is the program established for the procurement of electricity from community solar projects pursuant to ORS 757.386(2), the Commission's implementing regulations, and the Program Implementation Manual.

Community Solar Program Project is one or more solar photovoltaic energy systems used to generate electric energy on behalf of Community Solar Program owners and subscribers and for which owners and subscribers receive credit on their electric bills.

Conditional DNR Notice has the meaning provided in Section 3.1.

Contract Interest Rate means the lesser of (a) the highest rate permitted under applicable law or (b) 200 basis points per annum plus the rate per annum equal to the publicly announced prime rate or reference rate for commercial loans to large businesses in effect from time to time quoted by Citibank, N.A. as its "prime rate." If a Citibank, N.A. prime rate is not available, the applicable prime rate shall be the announced prime rate or reference rate for commercial loans in effect from time to time quoted by a bank with \$10 billion or more in assets in New York City, N.Y., selected by the Party to whom interest is being paid.

Contract Year means a twelve (12) month period commencing at 00:00 hours Pacific Prevailing Time (PPT) on January 1 and ending on 24:00 hours PPT on December 31; provided, however, that the first Contract Year shall commence on the Commercial Operation Date and end on the next succeeding December 31, and the last Contract Year shall end on the date of termination or expiration of this Agreement.

Effective Date means the date stated in the first sentence of this Agreement.

Energy Delivery Schedule has the meaning provided in Section 5.6.

Facility has the meaning provided in the Recitals.

Generation Interconnection Agreement means the generation interconnection agreement between Project Manager and Transmission Provider, providing for the construction, operation, and maintenance of the interconnection facilities required to accommodate deliveries of the Facility's Net Output.

Licensed Professional Engineer means a person acceptable to PacifiCorp in its reasonable judgment who is licensed to practice engineering in the state of Oregon and is not an employee of Project Manager. Such Licensed Professional Engineer shall be licensed in an appropriate engineering discipline for the required certification being made.

Losses are the loss of electric energy occurring as a result of the transformation and transmission of electric energy from the Facility to the Point of Delivery.

Net Output means all energy produced by the Facility, less Station Use and Losses, if any. For purposes of calculating payment under this Agreement, Net Output shall be the amount of energy flowing through the Point of Delivery.

Non-Firm Market Price Index means ninety three percent (93%) of the hourly value calculated based on the average prices reported for a blending of Intercontinental Exchange, Inc. (“ICE”) Day Ahead Power Price Report at market hubs for firm index prices for a given day, weighted by the count of hours for each ICE index on such day, multiplied by the then-current hourly energy scalars for a given day calculated under the methodology approved in the Resource Value of Solar docket (UM 1910) or a successor proceeding. If applicable, the resulting value will be reduced by the integration costs specified in the then-current standard avoided cost rate schedule as applicable to the Facility. The market blending and scalar matrices are available upon request. If any index is not available for a given period, the Non-Firm Market Price Index will be the average price derived from days in which all published data is available, for the same number of days immediately preceding and immediately succeeding the period in which an index was not available, regardless of which days of the week are used for this purpose. The Non-Firm Market Price Index will remain in effect until a replacement Non-Firm Market Price Index is approved by the Oregon Public Utility Commission.

Non-QF Period has the meaning provided in Section 3.5(b).

Participant means a customer of PacifiCorp that is either a subscriber or owner of the Facility.

Point of Delivery is the location where PacifiCorp’s and Facility’s electrical facilities are interconnected.

Program Administrator means the third-party directed by the Oregon Public Utility Commission to administer the Community Solar Program.

Program Implementation Manual means the manual of requirements applicable to the Project Manager, PacifiCorp and Participants for the Community Solar Program adopted by the Oregon Public Utility Commission. In the event there are revisions to the Program Implementation Manual during the term of this Agreement, such revisions will only apply to performance by Project Manager and PacifiCorp after the effective date of such revisions.

Project Manager is the entity having responsibility for managing the operation of the Facility and for maintaining contact with PacifiCorp, as stated in the first sentence of this Agreement.

Prudent Electrical Practices means those practices, methods, standards and acts engaged in or approved by a significant portion of the electric power industry in the Western Electric Coordinating Council that at the relevant time period, in the exercise of reasonable judgment in light of the facts known or that should reasonably have been known at the time a decision was made, would have been expected to accomplish the desired result in a manner consistent with good business practices, reliability, economy, safety and expedition, and which practices, methods, standards and acts reflect due regard for operation and

maintenance standards recommended by applicable equipment suppliers and manufacturers, operational limits, and all applicable law. Prudent Electrical Practices are not intended to be limited to the optimum practice, method, standard or act to the exclusion of all others, but rather to those practices, methods and acts generally acceptable or approved by a significant portion of the electric power generation industry in the relevant region, during the relevant period, as described in the immediately preceding sentence.

PURPA means the Public Utility Regulatory Policies Act of 1978.

Qualifying Facility is a solar photovoltaic facility that meets the PURPA criteria for qualification set forth in Subpart B of Part 292, Subchapter K, Chapter I, Title 18, of the Code of Federal Regulations.

Renewable Energy Credits means green tags, green certificates, renewable energy credits (RECs) and tradable renewable certificates, as those terms are commonly used in the regional electric utility industry, directly associated with the production of energy from the Facility.

Required Project Documents means all licenses, permits, authorizations, and agreements, including a Generation Interconnection Agreement and Qualifying Facility certification or self-certification, necessary for construction, operation, and maintenance of the Facility consistent with the terms of this Agreement, including without limitation those listed in Exhibit C.

Scheduled Commercial Operation Date has the meaning provided in the Recitals.

Start-up Test Energy means that portion of the Net Output of a Facility delivered to PacifiCorp before the Commercial Operation Date of the Facility. PacifiCorp will purchase Start-up Test Energy as Unsubscribed Energy in accordance with Section 3.2.

Station Use is electric energy used to operate the Facility that is auxiliary to or directly related to the generation of electricity and which, but for the contemporaneous generation of electricity, would not be consumed by the Facility.

Subscribed Energy means that portion of the Net Output delivered to PacifiCorp after the Commercial Operation Date and for which the Project Manager has obtained a Participant. PacifiCorp must credit the Participant's electric bills consistent with the Community Solar Program for any Subscribed Energy.

Transmission Provider means PacifiCorp, acting in its transmission provider capacity.

Unsubscribed Energy means that portion of the Net Output delivered to PacifiCorp that is not Subscribed Energy. PacifiCorp will purchase Unsubscribed Energy at the As-Available Rate consistent with the Community Solar Program.

SECTION 2: TERM

2.1 Term. Except as otherwise provided herein, this Agreement shall terminate at midnight (Pacific prevailing time) on the date that is the twentieth (20th) anniversary of the Commercial Operation Date.

SECTION 3: DELIVERY OF POWER AND COMPENSATION

3.1 Designation of Network Resource. Within five (5) business days following the Effective Date, PacifiCorp will submit an application to the Transmission Provider requesting designation of the Facility as a network resource, thereby authorizing network transmission service under PacifiCorp's

Network Integration Transmission Service Agreement with the Transmission Provider. PacifiCorp will request an effective date for commencement of network transmission service for the Facility that is (i) ninety (90) days prior to the Scheduled Commercial Operation Date, or (ii) as soon as practicable after both Parties have fully executed this Agreement if the Scheduled Commercial Operation Date is less than ninety (90) days following execution of this Agreement. PacifiCorp will inform Project Manager of Transmission Provider's response to the application described above in this paragraph within five (5) days of PacifiCorp's receipt of such response from the Transmission Provider. If PacifiCorp is notified in writing by the Transmission Provider that designation of the Facility as a network resource requires the construction of transmission system network upgrades or otherwise requires potential re-dispatch of other network resources of PacifiCorp (a "Conditional DNR Notice"), PacifiCorp and Project Manager will promptly meet to determine how such conditions to the Facility's network resource designation will be addressed in this Agreement. If, within sixty (60) days following the date of PacifiCorp's receipt of the Conditional DNR Notice, PacifiCorp and Project Manager are unable to reach agreement regarding how to designate the Facility as a network resource in light of the Conditional DNR Notice, PacifiCorp will submit the matter to the Commission for a determination on whether, as a result of the Conditional DNR Notice, this Agreement should be terminated or amended. PacifiCorp will submit such filing to the Commission within ninety (90) days following the date of PacifiCorp's receipt of the Conditional DNR Notice. In the event of such a filing to the Commission under this Section, the Parties' obligations under this Agreement will be suspended until such time that the Commission issues a final decision. In the event of a Conditional DNR Notice, Project Manager will have the right to terminate this Agreement upon written notice to PacifiCorp and such termination by Project Manager will not be an event of default and no damages will be owed by Project Manager to PacifiCorp related to the termination of this Agreement except to the extent PacifiCorp has incurred costs at Project Manager's request in furtherance of addressing the matters covered under this Section.

3.2 Delivery and Purchase of Start-up Test Energy. Subject to Section 3.1 above, to the extent permitted under applicable laws, regulations (including without limitation the Community Solar Program rules) and other requirements applicable to Project Manager's Community Solar Program Project, PacifiCorp will accept Start-up Test Energy delivered to the Point of Delivery as early as ninety (90) days prior to the Scheduled Commercial Operation Date, provided that PacifiCorp's obligation to purchase Start-up Test Energy from a Facility that is not at such time a Certified Project will not exceed a maximum period of one hundred twenty (120) days, or such time as may be directed by the Commission.

3.3 Delivery and Purchase of Net Output. Subject to Section 3.1 above and unless otherwise provided in this Agreement, commencing on the Commercial Operation Date (except as provided in Section 3.2 for Start-up Test Energy), Project Manager will transmit to PacifiCorp all Net Output and PacifiCorp will accept all Net Output delivered to the Point of Delivery. PacifiCorp will accept Net Output, including Start-up Test Energy, delivered to the Point of Delivery as early as ninety (90) days prior to the Scheduled Commercial Operation Date. If Project Manager desires to begin transmitting Net Output, including Start-up Test Energy, to PacifiCorp at a date earlier than ninety (90) days prior to the Scheduled Commercial Operation Date, PacifiCorp will only be obligated to purchase such Net Output, including Start-up Test Energy, if PacifiCorp is able to modify its network resource designation for the Facility such that the output could be delivered using network transmission service as described in Section 3.1 above at no additional cost or other economic impact to PacifiCorp.

3.4 Curtailement. PacifiCorp shall have no obligation to purchase Net Output from the Facility to the extent the interconnection between the Facility and PacifiCorp's electric system is disconnected, suspended or interrupted, in whole or in part, pursuant to the Generation Interconnection Agreement, or to the extent generation curtailment is required as a result of Project Manager's non-compliance with the Generation Interconnection Agreement.

3.5 Compensation. PacifiCorp will pay the Program Administrator for Unsubscribed Energy and the Participants for Subscribed Energy on a monthly basis as provided in the Community Solar Program.

(a) For the portion of the monthly Net Output that is Subscribed Energy, PacifiCorp will credit the electric bills of Participants to account for their proportionate share of the Net Output in accordance with the requirements of the Community Solar Program and data provided by the Program Administrator.

(b) For the portion of the monthly Net Output that is Unsubscribed Energy that is delivered to PacifiCorp by Project Manager from the Facility at the Point of Delivery, PacifiCorp will pay the Program Administrator the As-Available Rate consistent with the Community Solar Program; provided, however, that PacifiCorp has no obligation to pay Program Administrator for Unsubscribed Energy delivered to PacifiCorp for any period that Program Manager is in violation of Section 5.2 (the “Non-QF Period”). The Non-QF Period shall conclude upon PacifiCorp’s receipt from Program Manager of satisfactory evidence that the Facility has cured the breach of Section 5.2.

SECTION 4: RENEWABLE ENERGY CREDITS

4.1 No Claim to Renewable Energy Certificates. PacifiCorp waives any claim to ownership of any Renewable Energy Certificates that are issued by the Western Renewable Energy Generation Information System associated with the Facility’s Net Output.

SECTION 5: OPERATION AND CONTROL

5.1 Community Solar Program Compliance. Project Manager shall maintain the Facility as a Community Solar Program Project at all times during the term of this Agreement.

5.2 Qualifying Facility. Project Manager shall maintain the Facility as a Qualifying Facility at all times during the term of this Agreement.

5.3 As-Built Supplement. Upon completion of initial construction of the Facility, and upon any subsequent material modification of the Facility, Project Manager shall provide PacifiCorp an as-built supplement to specify the actual Facility as built.

5.4 Facility Operation. Project Manager must operate and maintain the Facility in a safe manner in accordance with the Generation Interconnection Agreement, Prudent Electrical Practices and in accordance with the requirements of all applicable federal, state and local laws and the National Electric Safety Code as such laws and code may be amended from time to time. PacifiCorp has no obligation to purchase Net Output from the Project Manager to the extent the interconnection between the Facility and PacifiCorp’s electric system is disconnected, suspended or interrupted, in whole or in part, pursuant to the Generation Interconnection Agreement.

5.5 Facility Inspection. Project Manager is solely responsible for the operation and maintenance of the Facility. PacifiCorp has the right, upon reasonable prior notice to Project Manager, to inspect the Facility to confirm that the Project Manager is operating the Facility in accordance with the provisions of this Agreement, provided that PacifiCorp is not, by reason of its decision to inspect or not to inspect the Facility, or by any action or inaction taken with respect to any such inspection, assuming any responsibility for any liability or occurrence arising from the operation and maintenance by Project Manager of the Facility.

5.6 Average Generation and Energy Delivery Schedules. Project Manager estimates that the average Net Output to be delivered to PacifiCorp for each Contract Year is 6,166,913 (“Average Annual Generation”). Project Manager may, upon at least six (6) months prior written notice, modify the Average Annual Generation every other Contract Year. Project Manager’s initial monthly schedule of expected Net Output from the Facility is attached as Exhibit D (the “Energy Delivery Schedule”). Project Manager must update and provide to PacifiCorp a revised Energy Delivery Schedule within thirty (30) days following the end of each Contract Year.

5.7 Scheduled Outages. Project Manager may cease operation of the entire Facility or individual units for maintenance or other purposes. Project Manager must exercise reasonable efforts to notify PacifiCorp of planned outages at least ninety (90) days prior to the planned outage. Additionally, Project Manager must use commercially reasonable efforts to not plan outages during the months of December and July.

5.8 Unplanned Outages. In the event of an unscheduled outage or curtailment exceeding twenty-five (25) percent of the facility capacity rating expected to last more than 48 hours, Project Manager must promptly notify PacifiCorp of the unscheduled outage or curtailment, the time when such occurred or will occur, and the anticipated duration.

5.9 Adjustments to Scheduled Commercial Operation Date. Project Manager must promptly notify PacifiCorp in writing of any adjustments (earlier or later) to the Scheduled Commercial Operation Date. Project Manager must also inform PacifiCorp in writing no later than ten (10) business days prior to the Scheduled Commercial Operation Date of the anticipated Commercial Operation Date, provided such notice to PacifiCorp may not be provided earlier than twenty (20) business days prior to the anticipated Commercial Operation Date.

SECTION 6: METERING AND COMMUNICATIONS

6.1 Metering and Communications.

(a) Metering equipment will be designed, furnished, installed, owned, inspected, tested, maintained and replaced pursuant to the terms of the Generation Interconnection Agreement and OAR 860-082-0070(2). Unless the Facility is exempt from providing or paying for data acquisition or telemetry equipment pursuant to OAR 860-082-0070(2), Project Manager will bear all costs (including PacifiCorp’s costs) relating to all metering and communication equipment installed to accommodate the Facility.

(b) Metering shall be performed at the location and in a manner consistent with this Agreement, the Generation Interconnection Agreement, and the requirements of the Community Solar Program. All quantities of energy purchased under this Agreement will be adjusted to account for electrical losses, if any, between the point of metering and the Point of Delivery, so that the purchased amount reflects the net amount of energy flowing into PacifiCorp’s system at the Point of Delivery.

(c) If any of the inspections or tests of the metering equipment discloses an error exceeding two percent (2%), either fast or slow, proper correction, based upon the inaccuracy found, will be made of previous readings for the actual period during which the metering equipment rendered inaccurate measurements if that period can be ascertained. If the actual period cannot be ascertained, the proper correction will be made to the measurements taken during the time the metering equipment was in service since the last test in which the metering equipment was found to be accurate, but not exceeding three (3) months, in the amount the metering equipment shall have been shown to be in error by such test.

Any correction in billings or payments resulting from a correction in the meter records will be made in the next payment rendered following the repair of the meter.

SECTION 7: INSURANCE

7.1 Certificates. To the extent the Facility has a facility capacity rating exceeding 200 kW, prior to connection of the Facility to PacifiCorp's electric system, Project Manager shall secure and continuously carry insurance in compliance with the requirements of this Section. Project Manager shall provide PacifiCorp insurance certificate(s) confirming Project Manager's compliance with the insurance requirements hereunder. If requested by PacifiCorp, a copy of each insurance policy, certified as a true copy by an authorized representative of the issuing insurance company, shall be furnished to PacifiCorp.

7.2 Required Policies and Coverages. Without limiting any liabilities or any other obligations of Project Manager under this Agreement, Project Manager shall secure and continuously carry with an insurance company or companies rated not lower than "B+" by the A.M. Best Company commercial general liability insurance to include premises and operations, contractual liability, with a minimum single limit of \$1,000,000 each occurrence to protect against and from loss by reason of injury to persons or damage to property based upon and arising out of the activity under this Agreement.

7.3 The commercial general liability policy required herein shall include (a) provisions or endorsements naming PacifiCorp, its board of directors, officers and employees as additional insureds, and (b) cross liability coverage so that the insurance applies separately to each insured against whom claim is made or suit is brought, even in instances where one insured claims against or sues another insured. In addition, unless prohibited by applicable law, all required insurance policies shall contain provisions that the insurer will have no right of recovery or subrogation against PacifiCorp.

7.4 The commercial general liability policy required herein shall include provisions that such insurance is primary insurance with respect to the interests of PacifiCorp and that any other insurance maintained by PacifiCorp is excess and not contributory insurance with the insurance required hereunder, and provisions that such policies shall not be canceled or their limits of liability reduced without (a) ten (10) days prior written notice to PacifiCorp if canceled for nonpayment of premium, or (b) thirty (30) days prior written notice to PacifiCorp if canceled for any other reason.

7.5 Commercial general liability coverage written on a "claims-made" basis, if any, shall be specifically identified on the certificate, and Project Manager shall be maintained by Project Manager for a minimum period of five (5) years after the completion of this Agreement and for such other length of time necessary to cover liabilities arising out of the activities under this Agreement.

SECTION 8: COMPUTATIONS

8.1 Net Output Data. No later than the second business day of each month, PacifiCorp will transfer to the Program Administrator the data related to the amount of Net Output delivered to PacifiCorp from the Facility for the month, measured in kWh.

SECTION 9: COMPENSATION

9.1 Payment for Unsubscribed Energy. No later than the 20th day of the month or ten (10) business days after receiving kWh data from Program Administrator regarding the prior month's Subscribed Energy amount and Unsubscribed Energy amount, whichever occurs later, PacifiCorp will send to Program Administrator payment for Project Manager deliveries of Unsubscribed Energy to PacifiCorp, together with computations supporting such payment. PacifiCorp may offset any such

payment to reflect amounts owing from Project Manager to PacifiCorp pursuant to this Agreement, the Generation Interconnection Agreement, or any other agreement between the Parties.

9.2 Corrections. PacifiCorp may adjust any payment made under this Agreement for Unsubscribed Energy or Subscribed Energy up to eighteen (18) months following the date of original payment.

9.3 Interest. Any amounts owing after the due date thereof will bear interest at the Contract Interest Rate.

9.4 Payment for Subscribed Energy. PacifiCorp will credit the electric bills of Participants for their proportionate shares of Subscribed Energy in accordance with the Program Implementation Manual and data provided by Program Administrator.

9.5 Offset. PacifiCorp may offset any payment due to the Project Manager by amounts owing from the Project Manager pursuant to this Agreement and any other agreement between the Parties related to the Facility.

SECTION 10: SUCCESSORS AND ASSIGNS

Neither Party may assign this Agreement without the consent of the other Party and the Oregon Public Utility Commission, which shall not be unreasonably withheld. This Agreement and all of the terms shall be binding upon and inure to the benefit of the respective successors and assigns of the Parties.

SECTION 11: NOTICES

All notices except as otherwise provided in this Agreement shall be in writing addressed to the addresses set forth below and shall be considered if delivered in person or when deposited in the U.S. Mail, postage prepared by certified or registered mail and return receipt requested.

Notices	PacifiCorp	Project Manager
All Notices:	PacifiCorp 825 NE Multnomah, Suite 600 Portland, Oregon 97232- 2315 Attn: Contract Administration E-mail: cntadmin@pacificorp.com	Green Solar LLC 700 17 th Street Suite 1500 Denver, CO 80202 Attention: Riley Sullivan Email: projects@solrivercapital.com
All Invoices:	Attn: Back Office, Suite 1900 Email: powerinvoices@pacificorp.com	Email: accounting@solrivercapital.com
Scheduling:	Attn: Pre-Scheduling, Suite 600 Phone: (503) 813-6090 Email: ctpreschd@pacificorp.com	Phone: (720) 593-1158 Email: projects@solrivercapital.com
Payments:	Attn: Central Cashiers Office, Suite 550 Phone: (503) 813-6826	Email: accounting@solrivercapital.com
Wire Transfer:	To be provided in separate letter from PacifiCorp to Project Manager	Acct Name: Green Solar, LLC Collection; Acct #: 116024603 Bank name: Amalgamated Bank

Notices	PacifiCorp	Project Manager
		Routing # for ACH and Wire: 026003379
Credit and Collections:	Attn: Credit Manager, Suite 600 Phone (503) 813-7280	Email: accounting@solrivercapital.com
Notices of an Event of Default or Potential Event of Default:	PacifiCorp Legal Department 825 NE Multnomah, Suite 2000 Portland, Oregon 97232- 2315 Attn: Assistant General Counsel	Green Solar LLC 700 17 th Street Suite 1500 Denver, CO 80202

SECTION 12: INDEMNIFICATION AND LIABILITY

12.1 Project Manager's Indemnity. Project Manager agrees to defend, indemnify and hold harmless PacifiCorp, its directors, officers, employees, agents, and representatives against and from any and all claims resulting from, or arising out of or in any way connected with (i) Project Manager's performance hereunder, including the delivery of energy to and at the Point of Delivery; (ii) Project Manager's development, construction, ownership, operation, maintenance, or decommissioning of the Facility; (iii) the violation of any law, rule, order or regulation by Project Manager or any of its affiliates, or their respective employees, contractors or agents in connection with this Agreement; (iv) Project Manager's failure to perform any of Project Manager's obligations under this Agreement or the Required Facility Documents; (v) Project Manager's breach of any representation or warranty set forth in this Agreement; or (vi) Project Manager's negligence or willful misconduct in connection with this Agreement, except to the extent such claim is caused by breach of this Agreement or by the negligence or willful misconduct of PacifiCorp, its directors, officers, employees, agents or representatives.

12.2 PacifiCorp's Indemnity. PacifiCorp agrees to defend, indemnify and hold harmless Project Manager, its directors, officers, agents, and representatives against and from any and all claims resulting from, or arising out of or in any way connected with (i) PacifiCorp's receipt of Net Output under this Agreement after its delivery at the Point of Delivery; (ii) the violation of any law, rule, order or regulation by PacifiCorp, or their respective employees, or agents in connection with this Agreement; (iii) PacifiCorp's failure to perform any of PacifiCorp's obligations under this Agreement; (iv) PacifiCorp's breach of any representation or warranty set forth in this Agreement; or (v) PacifiCorp's negligence or willful misconduct in connection with this Agreement, except to the extent such claim is caused by Project Manager's breach of this Agreement or by the negligence or willful misconduct of Project Manager, its directors, officers, employees, agents or representatives.

12.3 No Dedication. Nothing in this Agreement shall be construed to create any duty to, any standard of care with reference to, or any liability to any person not a Party to this Agreement. No undertaking by one Party to the other under any provision of this Agreement shall constitute the dedication of that Party's system or any portion thereof to the other Party or to the public, nor affect the status of PacifiCorp as an independent public utility corporation or Project Manager as an independent person.

12.4 Disclaimer of Consequential Damages. **NEITHER PARTY SHALL BE LIABLE TO THE OTHER FOR SPECIAL, PUNITIVE, INDIRECT OR CONSEQUENTIAL DAMAGES UNDER OR IN RESPECT OF THIS AGREEMENT, WHETHER ARISING FROM CONTRACT, TORT (INCLUDING NEGLIGENCE), STRICT LIABILITY OR OTHERWISE.**

SECTION 13: TERMINATION

13.1 Termination. In the event Project Manager remains in breach of any provision of this Agreement for a period exceeding thirty (30) days following PacifiCorp's notice of breach, PacifiCorp may notify Program Administrator in writing to request that the Agreement be terminated for the event of default. The Program Administrator will evaluate such notification consistent with the Community Solar Program, and such Agreement will be terminated only upon order of the Program Administrator or the Commission.

SECTION 14: GENERAL PROVISIONS

14.1 Relationship of the Parties. Nothing contained in this Agreement shall ever be construed to create an association, trust, partnership or joint venture or to impose a trust or partnership duty, obligation or liability between the Parties. If Project Manager includes two or more parties, each such Party shall be jointly and severally liable for Project Manager's obligations under this Agreement.

14.2 No Third Party Beneficiaries. This Agreement shall not impart any rights enforceable by any third party (other than a permitted successor or assignee bound to this Agreement), it being the intent of the Parties that this Agreement shall not be construed as a third party beneficiary contract.

14.3 Governing Law. This Agreement shall be interpreted and enforced in accordance with the laws of the state of Oregon, excluding any choice of law rules which may direct the application of the laws of another jurisdiction. This Agreement is subject to the jurisdiction of those governmental agencies and courts having control over either Party or this Agreement. Each Party hereby acknowledges that this Agreement and any dispute that arises under this Agreement is subject to the jurisdiction of the Oregon Public Utility Commission. If a dispute related to this Agreement arises between the Parties, the Parties' representatives shall first attempt to resolve the dispute informally through negotiation and consultation. If the Parties are unable to resolve their differences through such negotiation and consultation, any complaint, claim or action to resolve such dispute may be brought in a court or governmental agency with jurisdiction over the dispute.

14.4 Severability. If any of the terms of this Agreement are finally held or determined to be invalid, illegal or void as being contrary to any applicable law or public policy, all other terms of this Agreement shall remain in effect. If any terms are finally held or determined to be invalid, illegal or void, the Parties shall enter into negotiations, and seek guidance from the Program Administrator and Oregon Public Utility Commission as necessary, concerning the terms affected by such decision for the purpose of achieving conformity with requirements of any applicable law, the intent of the Parties, and the Community Solar Program.

14.5 Effect of PURPA Repeal. The repeal of PURPA shall not result in the early termination of this Agreement unless such termination is mandated by state or federal law.

14.6 Waiver. Any waiver at any time by either Party of its rights with respect to a default under this Agreement or with respect to any other matters arising in connection with this Agreement must be in writing, and such waiver shall not be deemed a waiver with respect to any subsequent default or other matter.

14.7 Survival. Notwithstanding termination of this Agreement, PacifiCorp and Project Manager shall continue to be bound by the provisions of this Agreement which by their terms or by their nature shall survive such completion or termination.

14.8 Entire Agreement; Amendments; Order of Precedence. This Agreement supersedes all prior agreements, proposals, representations, negotiations, discussions or letters, whether oral or in writing, regarding PacifiCorp's purchase of energy from the Facility. No amendment or modification of this Agreement shall be effective unless it is in writing and signed by both Parties. If there is a conflict between the terms of this Agreement and the Community Solar Program the Community Solar Program shall apply and prevail.

14.9 Project Release. By executing this Agreement, Project Manager releases PacifiCorp from any third party claims related to the Facility, known or unknown, which may have arisen prior to the Effective Date.

14.10 Rights and Remedies Cumulative. Except as expressly set forth in this Agreement, the rights and remedies of the Parties provided in this Agreement and otherwise available at law or in equity are cumulative, such that the exercise of one or more rights or remedies shall not constitute a waiver of any other rights or remedies.

[remainder of page intentionally left blank]

IN WITNESS WHEREOF, the Parties hereto have caused this Agreement to be executed in their respective names as of the Effective Date.

PacifiCorp

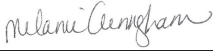
By:  Melanie Cunningham
2023.11.03 11:14:05 -07'00'

Name: Melanie Cunningham

Title: Associate Power Marketer

Date: November 3, 2023

Project Manager

By: 
Riley Sullivan (Oct 25, 2023 09:35 MDT)

Name: Riley Sullivan

Title: Manager

Date: 10/24/2023

EXHIBIT A
DESCRIPTION OF PROJECT MANAGER'S FACILITY

[Project Manager to Complete]

Location of the Facility: The Facility is to be constructed in the vicinity of Culver in Jefferson County, Oregon. The location is more particularly described as follows:

That portion of the Southwest quarter and the South half of the Northwest quarter of Section 36, Township 12 South, Range 12 East of the Willamette Meridian, Jefferson County, Oregon lying Westerly of the Oregon Trunk Railroad right of way, and East of Grean Drive.

Together with the following-described mobile home which is firmly affixed to the property:

1975 Broadmore, 14 x 60, Serial Number S6357

Description of the Facility: Project Manager's Facility consists of 5,684 solar panels rated at 655 watts DC and an expected annual degradation rate of 0.5 % manufactured by Canadian Solar (or equivalent), 1 inverter manufactured by Sungrow, and an Array Technologies DuraTrack HZ tracking system.

More specifically, each generator at the Facility is described as:

Manufacturer's Nameplate Data: 3,723 KW DC, 2,875 KW AC

Solar Panels

Manufacturer: Canadian Solar or equivalent

Model: CS7N-655MG-AG

Power rating (Watts DC @ STC): 655W

Number of Modules: 5,684

Number of Modules per string: 28

Inverters

Manufacturer: Sungrow or equivalent

Model: SG3425/3600UD-MV

Inverter Rating (AC, kW): 2,875

Number of Inverters: 1

Inverter Efficiency at Full Power Rating (%): 99%

Inverter Capacity for Site (AC, kW): 2875

Operation Voltage (Volts): 600Vac

Maximum System Design Voltage: 600Vac

Number of Phases: 3

Mounting

Groundmount or rooftop? Groundmount
 Fixed tilt or Single-axis Tracking? Single-axis Tracking
 Proposed Module orientation: _____
 Tilt Angle (Degrees): __
 Azimuth (Degrees): 0
 Pitch (Row Spacing) (Feet): 18.5'
 Row Width (Feet): 10.68
 Row Length (Feet): 375
 Max/min rotation (if tracking) (Degrees): +52/-52
 Ground Coverage Ratio: 42.3%

PV Array Characteristics

Rated Output (kW): 3,723 kW DC / 2,875 kW AC
 Rated Output (kVA): 2875 kVA

Transformation

Number of Step-up transformers: 2
 Size of Step-up Transformers (kVA): 3425
 Low Side voltage of Step-up transformer (volts): 600Vac
 High Side voltage of Step-up transformer (volts): 12.47 kVac

Total land required: 12.77 acres

Power factor requirements

Rated Power Factor (PF) or reactive load (kVAR): PF=>0.99(1)
 Leading: 0.8 Lagging: 0.8

Project Manager's Estimate of Facility Annual Output Under Ideal (Maximum) or Worst (Minimum) Conditions

Maximum kW Output ("Maximum Facility Delivery Rate"): 2,875 kW AC
 Maximum kVA Output: 2,875 kVA
 Minimum kW Output: 2,875 kW
 Estimated kW Output: 2,875 kW AC
 Maximum Generator Interconnection Agreement Delivery Rate: 2,875 kW (instantaneous)

Nameplate Capacity Rating: 2875kW AC at 25° C

Estimated station service for lighting and other auxiliary energy requirements is estimated to be approximately 0 kWh annually.

PV Panel output degradation factor: 0.5 % per year.

EXHIBIT B

POINT OF DELIVERY / PROJECT MANAGER’S INTERCONNECTION FACILITIES

Green Solar, LLC is to be interconnected to the Public Utility’s distribution circuit 5D5 out of Culver substation via a 12.47 kV primary meter. The Point of Interconnection (“POI”) will be located at approximately 44.486, -121.250 located in Jefferson County, Oregon. Figure 2 below is a one-line diagram that illustrates the interconnection of the Project to the Public Utility’s system.

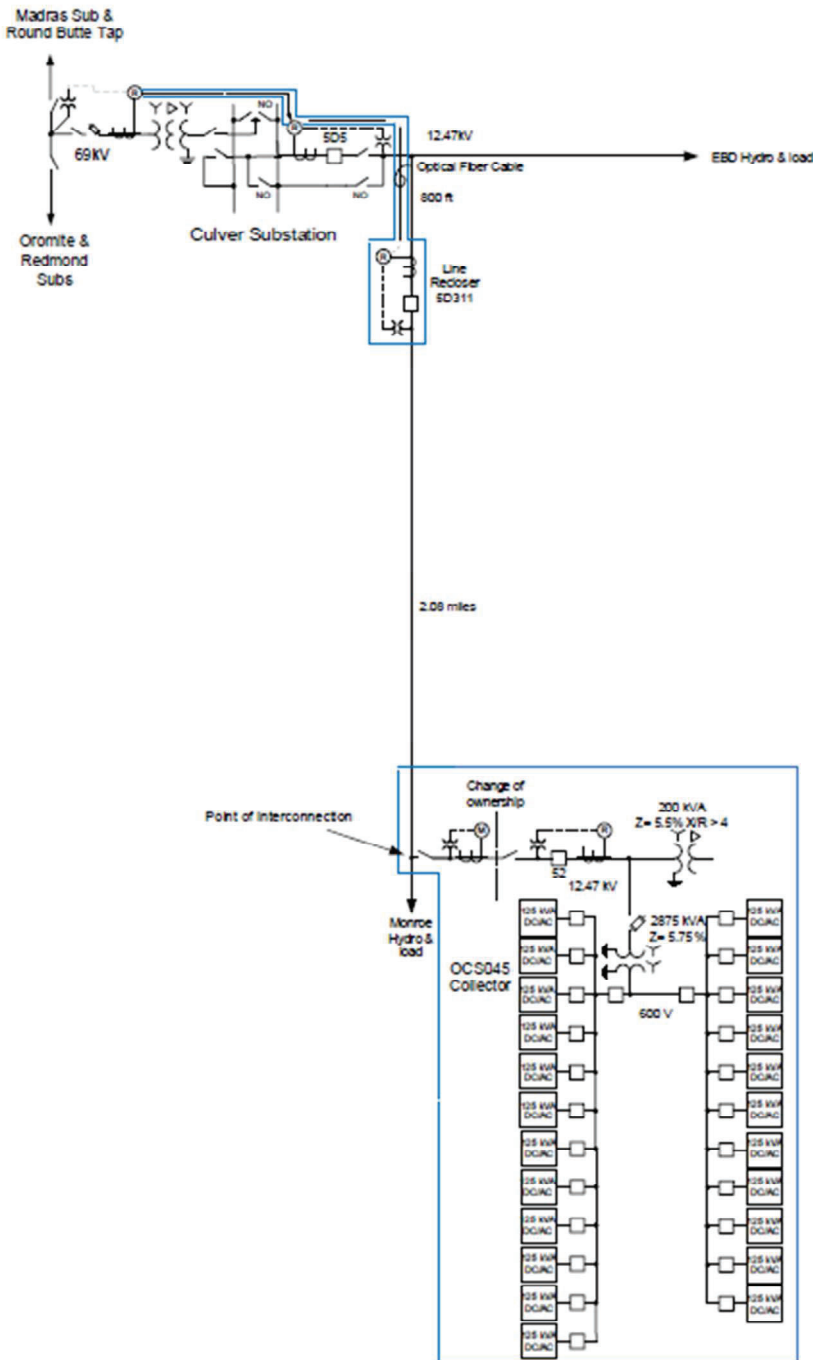

System One Line Diagram

Figure 1:

EXHIBIT C
REQUIRED FACILITY DOCUMENTS

1. QF Certification Form 556 Docket #QF22-811-000
2. Interconnection Agreement OCS045 Small Generator Interconnection Agreement (SGIA) executed April 22, 2021
3. PP-2021-99 Community Solar Program (CSP) Pre-Certification: Docket No. UM 1930 of the Public Utility Commission of Oregon, entered March 31, 2022
4. PP-2021-99 - CSP Certification: TBD*
*To be appended after PPA completion (see Program Implementation Manual)

EXHIBIT D
ENERGY DELIVERY SCHEDULE

Month	Year 1 - Expected Energy (kWh)
January	206,465
February	302,330
March	483,620
April	652,132
May	778,602
June	843,188
July	916,487
August	812,556
September	630,071
October	425,138
November	238,885
December	180,944
First Year Total	6,470,419

The energy values above will be reduced 0.5 percent for expected degradation each Contract Year following the Commercial Operation Date.

Project Manager to provide an estimate of the average monthly Net Output of the Facility, and explain the basis for the estimate.



September 29, 2023

Brandon Conard
SolRiver Capital LLC
On behalf of Green Solar LLC
700 17th Street, Suite 1500
Denver, CO 80202

Director, Transmission Services
PacifiCorp
825 NE Multnomah, Suite 1600
Portland, OR 97232

To Whom it May Concern:

Green Solar LLC (“Project Manager”) hereby voluntarily authorizes PacifiCorp's Transmission business unit to share Project Manager's interconnection information with marketing function employees of PacifiCorp, including but not limited to those in Energy Supply Management. Project Manager acknowledges that PacifiCorp did not provide it any preferences, either operational or rate-related, in exchange for this voluntary consent.

Sincerely,

A handwritten signature in black ink, appearing to be "BC", written over a horizontal line.

Brandon Conard
Manager – Green Solar LLC
(720) 593-1158
brandon@solrivercapital.com





Green Solar - CSP Purchase Agreement _ Execution Draft 10-17-23

Final Audit Report

2023-10-25

Created:	2023-10-25
By:	Edward Shogry (edward@solrivercapital.com)
Status:	Signed
Transaction ID:	CBJCHBCAABAAhnS-ZxqeNXhV8_nvzZCdVQGiuEIJk0Yr

"Green Solar - CSP Purchase Agreement _ Execution Draft 10-17-23" History

-  Document created by Edward Shogry (edward@solrivercapital.com)
2023-10-25 - 3:33:33 PM GMT
-  Document emailed to Riley Sullivan (riley@solriver.com) for signature
2023-10-25 - 3:34:10 PM GMT
-  Email viewed by Riley Sullivan (riley@solriver.com)
2023-10-25 - 3:35:39 PM GMT
-  Document e-signed by Riley Sullivan (riley@solriver.com)
Signature Date: 2023-10-25 - 3:35:49 PM GMT - Time Source: server
-  Agreement completed.
2023-10-25 - 3:35:49 PM GMT