

**BEFORE THE PUBLIC UTILITY COMMISSION
OF OREGON**

UM 1880

Served electronically at Salem, Oregon, 8/8/17, to:

Respondent's Attorney
V. Denise Saunders
Portland General Electric Company
121 SW Salmon Street
Portland, Oregon 97204
denise.saunders@pgn.com

Complainant's Attorneys & Representative
Irion A. Sanger
Sidney Villanueva
Sanger Law, PC
1117 SE 53rd Avenue
Portland, Oregon 97215
irion@sanger-law.com
sidney@sanger-law.com

Chris Norqual
Skyward Solar, LLC
3250 Ocean Park Blvd., Suite 355
Santa Monica, CA 90405

Re: UM 1880, Complainant SKYWARD SOLAR, LLC
vs. PORTLAND GENERAL ELECTRIC COMPANY, Respondent

Skyward Solar, LLC has filed a complaint against Portland General Electric. A copy of the complaint is attached and served on Respondent, under ORS 756.512(1). The Commission has assigned Docket No. UM 1880 to this complaint. Please use this number whenever you refer to this case.

The Public Utility Commission must receive an Answer from the Respondent or their attorney by August 28, 2017, under OAR 860-001-0400(4)(a). A copy must be served on the complainant.

After the filing of the answer, the matter will be set for hearing and you will be notified of the time and place.

PUBLIC UTILITY COMMISSION OF OREGON

/s/Cheryl Walker
Cheryl Walker
Administrative Specialist 2
Administrative Hearings Division
(503) 378-2849

c: Barbara Parr, barbara.parr@pgn.com

Attachments: Complaint; Notice of Contested Case Rights and Procedures

NOTICE OF CONTESTED CASE RIGHTS AND PROCEDURES

Oregon law requires state agencies to provide parties written notice of contested case rights and procedures. Under ORS 183.413, you are entitled to be informed of the following:

Hearing: The time and place of any hearing held in these proceedings will be noticed separately. The Commission will hold the hearing under its general authority set forth in ORS 756.040 and use procedures set forth in ORS 756.518 through 756.610 and OAR Chapter 860, Division 001. Copies of these statutes and rules may be accessed via the Commission's website at www.puc.state.or.us. The Commission will hear issues as identified by the parties.

Right to Attorney: As a party to these proceedings, you may be represented by counsel. Should you desire counsel but cannot afford one, legal aid may be able to assist you; parties are ordinarily represented by counsel. The Commission Staff, if participating as a party in the case, will be represented by the Department of Justice. Generally, once a hearing has begun, you will not be allowed to postpone the hearing to obtain counsel.

Administrative Law Judge: The Commission has delegated the authority to preside over hearings to Administrative Law Judges (ALJs). The scope of an ALJ's authority is defined in OAR 860-001-0090. The ALJs make evidentiary and other procedural rulings, analyze the contested issues, and present legal and policy recommendations to the Commission.

Hearing Rights: You have the right to respond to all issues identified and present evidence and witnesses on those issues. *See* OAR 860-001-0450 through OAR 860-001-0490. You may obtain discovery from other parties through depositions, subpoenas, and data requests. *See* ORS 756.538 and 756.543; OAR 860-001-0500 through 860-001-0540.

Evidence: Evidence is generally admissible if it is of a type relied upon by reasonable persons in the conduct of their serious affairs. *See* OAR 860-001-0450. Objections to the admissibility of evidence must be made at the time the evidence is offered. Objections are generally made on grounds that the evidence is unreliable, irrelevant, repetitious, or because its probative value is outweighed by the danger of unfair prejudice, confusion of the issues, or undue delay. The order of presenting evidence is determined by the ALJ. The burden of presenting evidence to support an allegation rests with the person raising the allegation. Generally, once a hearing is completed, the ALJ will not allow the introduction of additional evidence without good cause.

Record: The hearing will be recorded, either by a court reporter or by audio digital recording, to preserve the testimony and other evidence presented. Parties may contact the court reporter about ordering a transcript or request, if available, a copy of the audio recording from the Commission for a fee set forth in OAR 860-001-0060. The hearing record will be made part of the evidentiary record that serves as the basis for the Commission's decision and, if necessary, the record on any judicial appeal.

Final Order and Appeal: After the hearing, the ALJ will prepare a draft order resolving all issues and present it to the Commission. The draft order is not open to party comment. The Commission will make the final decision in the case and may adopt, modify, or reject the ALJ's recommendation. If you disagree with the Commission's decision, you may request reconsideration of the final order within 60 days from the date of service of the order. *See* ORS 756.561 and OAR 860-001-0720. You may also file a petition for review with the Court of Appeals within 60 days from the date of service of the order. *See* ORS 756.610.

Irion A. Sanger
 OSB No. 003750
 Sanger Law, PC
 1117 SE 53rd Ave.
 Portland, Oregon 97215
 503-756-7533 (tel.)
 503-334-2235 (fax)
 irion@sanger-law.com

BEFORE THE PUBLIC UTILITY COMMISSION
OF OREGON

Skyward Solar, LLC,)	
Complainant,)	DOCKET NO. ____
)	
v.)	COMPLAINT
)	
Portland General Electric Company,)	
Defendant.)	
)	
_____)	

I. INTRODUCTION

1
 2 This is a complaint (“Complaint”) filed by Skyward Solar LLC (“Skyward Solar”
 3 or “Complainant”) with the Oregon Public Utility Commission (the “Commission” or
 4 “OPUC”) under Oregon Revised Statute (“ORS”) 756.500 and Oregon Administrative
 5 Rule (“OAR”) 860-001-0170. Portland General Electric Company (“PGE” or the
 6 “Company”) has not agreed to purchase the net output from Skyward Solar’s qualifying
 7 facility (“QF”) as a mandatory purchase under the Public Utility Regulatory Policies Act
 8 of 1978 (“PURPA”). PGE has failed to comply with its own rate Schedule 201, the
 9 Commission’s rules and policies, the Federal Energy Regulatory Commission’s
 10 (“FERC’s”) rules and policies, and the Oregon and federal PURPA statutes. PGE has
 11 refused to finalize or execute a power purchase agreement (“PPA”) with Skyward Solar.

1 Skyward Solar has formed a legally enforceable obligation because it has been
2 ready, willing, and able to sign a PPA with PGE since at least April 26, 2017, and has
3 repeatedly and unequivocally committed itself to sell the net output to PGE at the
4 Schedule 201 avoided cost rates and standard PPA terms and conditions that were in
5 effect prior to June 1, 2017 (the “Pre-June 1 Rates and Terms”). PGE should be required
6 to execute a PPA with Skyward Solar at the Pre-June 1 Rates and Terms because the
7 establishment of a legally enforceable obligation turns on Skyward Solar’s commitment
8 rather than PGE’s actions.

9 The concept of a legally enforceable obligation under PURPA exists precisely to
10 prevent what PGE has sought to achieve here: preventing Skyward Solar from obtaining
11 a PPA on favorable terms. PGE’s actions seeking to prevent Skyward Solar from
12 entering into a PPA at the the Pre-June 1 Rates and Terms include, but are not limited to:
13 1) delaying the PPA negotiation process; 2) seeking interim and/or expedited relief to
14 prevent Skyward Solar from being able to execute a PPA and to lower rates; and
15 3) failing to inform Skyward Solar about its filings seeking to change its Standard PPA
16 rules and rates. These actions by PGE violated PURPA, the Commission’s and FERC’s
17 rules and policies, and PGE’s own Schedule 201

18 Among other things, PGE ignored Skyward Solar’s requests for expedited
19 processing on April 27; ignored Skyward Solar’s requests for an executable PPA on May
20 23 and May 31; refused Skyward Solar’s requests to meet in person on May 26; waited
21 until May 31 to inform Skyward Solar about its June 1 rate change; and completely
22 ignored the partially executed PPA Skyward Solar submitted on May 31.

1 The Commission cannot revise its own rules or policies to lower the size
2 threshold, impose an ownership cap, adopt an early avoided cost rate reduction, or make
3 other changes in a manner that effectively prevents Skyward Solar from committing itself
4 to sell the net output of its project or otherwise creating a legally enforceable obligation
5 under the then-current avoided cost rate. Skyward Solar relied upon the Commission's
6 settled and uniform institutional climate for QFs, and expects the Commission to uphold
7 its policies regarding eligibility for standard avoided cost rates and contracts, including
8 that Skyward Solar is able to enter contracts or create legally enforceable obligations
9 based on the policies and rules in effect at the time that the QF makes its request for a
10 PPA.

11 Given PGE's refusal to execute a PPA and attempt to change Commission
12 policies and rates to prevent Skyward Solar from executing a PPA at the Pre-June 1 Rates
13 and Terms, Skyward Solar respectfully requests the Commission confirm: 1) that
14 Skyward Solar established a legally enforceable obligation with PGE based on Skyward
15 Solar's commitment to sell its net output under a partially executed PPA, which is the
16 same as the Commission's approved contract and rates and both draft PPAs provided by
17 PGE; and 2) require PGE to enter into a PPA with Skyward Solar with the terms, and
18 conditions under the current Schedule 201 and the standard renewable rate in effect when
19 Skyward Solar executed PGE's draft PPA on May 31, 2017.

20

II. SERVICE

21 Copies of all pleadings and correspondence should be served on Skyward Solar's
22 counsel and representatives at the addresses below:
23

1 Irion Sanger Sidney Villanueva
2 Sanger Law, PC Sanger Law, PC
3 1117 SE 53rd Ave. 1117 SE 53rd Ave.
4 Portland, Oregon 97215 Portland, Oregon 97215
5 irion@sanger-law.com sidney@sanger-law.com
6

7 Chris Norqual
8 Skyward Solar, LLC
9 3250 Ocean Park Blvd., Suite 355
10 Santa Monica, CA 90405
11 norqual@ccrenew.com
12

13 In support of this Complaint, Skyward Solar alleges as follows:

14 **III. IDENTITY OF THE PARTIES**

15 1. PGE is an investor-owned public utility regulated by the Commission
16 under ORS Chapter 757. PGE is headquartered at 121 Southwest Salmon Street,
17 Portland, Oregon 97204.

18 2. Skyward Solar, a limited liability company organized under the laws of
19 Oregon, is the owner of the QF and will be the seller of the net output of the QF project.
20 Skyward Solar's address is 3250 Ocean Park Blvd., Suite 355, c/o Chris Norqual, 3250
21 Ocean Park Blvd., Suite 355, Santa Monica, CA 90405.

22 **IV. APPLICABLE STATUTES AND RULES**

23 3. The Oregon statutes expected to be involved in this case include:
24 ORS 756.040-756.068, 756.500-756.558, 756.990, and 758.505-758.575. The Oregon
25 rules expected to be involved in this case include: OAR 860-001, and 860-029.

26 4. The federal statute expected to be involved in this case is PURPA, 16
27 United States Code ("USC") 824a-3. The federal rules expected to be involved in this
28 case include: 18 Code of Federal Regulations ("CFR") 292.101-292.602. FERC's

1 regulations regarding its pro forma Open Access Transmission Tariffs (“OATT”) may
2 also be involved.

3 V. JURISDICTION

4 5. FERC has adopted regulations and policies governing utility purchases
5 from QFs under PURPA. 18 CFR 292.101-292.602. State regulatory agencies are
6 required to implement FERC’s regulations. See 16 USC 824a-3(f); FERC v. Mississippi,
7 456 U.S. 742, 751, 102 S. Ct. 2126 (1982). FERC’s rules provide each QF with the right
8 to unilaterally create a legally enforceable obligation to sell its energy and capacity at
9 projected avoided cost rates in effect on the date that the QF obligates itself to sell energy
10 and capacity. 18 CFR 292.304(d)(2)(ii); FLS Energy Inc., 157 FERC ¶ 61,211 at PP 23-
11 25 (2016).

12 6. Oregon law also includes a requirement that a QF has the right to legally
13 obligate itself to sell its net output at a time prior to the delivery of its net output.
14 Specifically, ORS 758.525(2)(b) provides: “At the option of the qualifying facility,
15 exercised before beginning delivery of the energy or energy and capacity, such prices
16 may be based on . . . [t]he projected avoided costs calculated at the time the legal
17 obligation to purchase the energy or energy and capacity is incurred.” Thus, the
18 “obligation to purchase power is imposed by law on a utility; it is not voluntarily
19 assumed.” Snow Mountain Pine Co. v. Maudlin, 734 P.2d 1366, 84 Or. App. 590, 598
20 (1987).

21 7. The Commission is the Oregon state agency that implements the state and
22 federal PURPA statutes. ORS 758.505(3); OAR 860-029-0001; Snow Mountain, 84 Or.
23 App. at 593. Public utilities are defined in ORS 758.505(7), and include PGE. Oregon

1 law provides that the “terms and conditions for the purchase of energy or energy and
2 capacity from a qualifying facility shall . . . [b]e established by rule by the commission if
3 the purchase is by a public utility.” ORS 758.535(2)(a). The Commission has the power
4 and jurisdiction to hear complaints by QFs against public utilities, including PGE. ORS
5 756.040, 756.500-756.558, and 758.505-758.555; OAR 860-001-0010(3), and 860-029-
6 0030.

7 **VI. FACTUAL BACKGROUND**

8 8. The Skyward Solar project will be a 2.2 megawatt (“MW”) nameplate
9 solar generation facility located in Clackamas County, Oregon.

10 9. On April 20, 2017, Skyward Solar sent a letter to PGE indicating its desire
11 to sell its full net output to PGE according to the Schedule 201 effective October 12,
12 2016.

13 10. On April 26, 2017, Skyward Solar provided information and materials
14 required for a standard PPA with PGE.

15 11. On May 1, 2017, PGE acknowledged receipt of Skyward Solar’s
16 application, noting that it was received on April 26 and that PGE would either provide a
17 draft PPA or request additional information by May 16, 2017.

18 12. Skyward Solar was aware that PGE would make its annual cost rate
19 update filing on May 1, 2017, and based on past history, expected PGE’s avoided cost
20 rate might change in the end of June 2017.

21 13. Skyward Solar was aware that PGE’s integrated resource plan is scheduled
22 for acknowledgment at the end of August 2017, and expected PGE’s avoided cost rates to
23 be revisited again about two months later, or the end of October 2017.

1 14. Over the course of the next several weeks, Skyward Solar and PGE
2 exchanged information and communicated regarding issues related to the sale of its net
3 output to PGE, including but not limited to contract terms, required information, and
4 project details.

5 15. On May 1, 2017, PGE filed its May 1 Update, which requested an
6 effective date of May 17, 2017 for its updated avoided cost rates rather than the end of
7 June as Skyward Solar expected. PGE's May 1 Update proposed to lower PGE's avoided
8 cost rate significantly.

9 16. PGE never informed Skyward Solar that it was planning to seek approval
10 of its May 1 Update at the May 16, 2017 Public Meeting rather than the last Public
11 Meeting scheduled in June as it has done in past years.

12 17. Similarly, PGE never informed Skyward Solar that it was planning to
13 request an effective date of May 17, 2017 for its May 1 Update.

14 18. Skyward Solar would have proceeded through its PPA negotiations more
15 quickly, and may not have requested any changes to PGE's draft PPA, if it had been
16 aware that PGE intended to request a May 17, 2017 effective date for its May 1 Update.
17 Skyward Solar was denied the opportunity to make decisions on the basis of complete
18 information, because PGE did not share its plans with the QFs it was negotiating with.

19 19. Commission Staff considered addressing PGE's May 1 Update at the May
20 30, 2017 Public Meeting, but ultimately moved that consideration to a Special Public
21 Meeting on May 18, 2017 per PGE's request. Re Portland General Electric Company
22 Updates Qualifying Facilities Avoided Cost Payments, Schedule 201, UM 1728, Special
23 Public Meeting at 2:18 (May 18, 2017).

1 20. On or about May 1, 2017, PGE also decided to file a request for new solar
2 QF limits, which is currently being reviewed under docket number UM 1845 (“Request
3 for New Solar QF Limits”). PGE’s Request for New Solar Limits would, among other
4 things, declare that a solar QF project with a capacity above 100 kilowatts (“kW”) is not
5 eligible for a standard contract or standard prices from PGE if any owner of the solar QF
6 project has requested or obtained standard prices from PGE for more than 10 MW of
7 solar QF capacity; or in the alternative, lower to 2 MW the eligibility cap for a solar QF
8 project to obtain prices from PGE.

9 21. PGE’s Request for New Solar Limits, if granted, could affect Skyward
10 Solar’s eligibility for standard avoided cost prices, if Skyward Solar were not able to
11 establish a legally enforceable obligation under PGE’s Standard PPA terms and rates in
12 effect on May 31, 2017.

13 22. PGE chose not to inform Skyward Solar that it was planning to file the
14 Request for New Solar QF Limits, or that PGE was planning to seek interim relief.

15 23. Skyward Solar would have proceeded through its PPA negotiations more
16 quickly , and may not have requested any changes to PGE’s draft PPA, if it had been
17 aware that PGE intended to file the Request for New Solar QF Limits. Skyward Solar
18 was denied the opportunity to make decisions on the basis of complete information,
19 because PGE did not share its plans with the QFs it was negotiating with.

20 24. On May 15, 2017, PGE provided Skyward Solar with a draft PPA. PGE’s
21 May 15 letter was dated May 16, 2017, but was emailed on May 15, 2017.

22 25. On May 18, 2017, the Commission held a Special Public Meeting to
23 consider PGE’s May 1 Update, and allowed PGE’s new avoided cost rates to go into

1 effect on June 1, 2017. Re Portland General Electric Company Application to Update
2 Schedule 201 Qualifying Facility Information, Docket No. UM 1728, Order No. 17-177
3 (May 19, 2017).

4 26. After the May 18, 2017 Special Public Meeting, PGE chose not to inform
5 Skyward Solar that its Schedule 201 had been adopted, or that its avoided cost rates were
6 going to drop substantially on June 1, 2017.

7 27. On May 23, 2017, Skyward Solar sent an email to PGE requesting
8 execution copies of the draft PPA with five changes, including: 1) removing expected
9 dates from Exhibit B; 2) removing point 7 from Exhibit C; 3) revising Section 4.5 to
10 match Skyward Solar's July 28, 2015 contract; 4) revising Section 49.2 to match
11 Skyward Solar's July 28, 2015 contract; and 5) deleting Section 9.1.6 and 9.3 to match
12 Skyward Solar's July 28, 2015 contract. Skyward Solar believed that this request would
13 not constitute substantive changes to PGE's draft PPA.

14 28. On May 26, 2017, Skyward Solar sent an email to PGE revising its request
15 to include only two changes, including: 1) removing point 7 from Exhibit C; and 2)
16 updating the commercial operation date in Sections 2.2.1 and 2.2.2 to May 1, 2020.
17 Skyward Solar removed any requests it believed might be objectionable to PGE.

18 29. The May 26 email explained Skyward Solar's intention in revising the
19 change requests was to avoid any substantive updates and proceed with executable PPAs
20 as soon as possible. It expressly reiterated Skyward Solar's request to receive an
21 executable PPA before May 31, 2017, and requested a meeting with PGE to discuss
22 moving things forward.

1 30. On May 30, 2017, Skyward Solar left a voicemail reiterating its request to
2 meet with PGE to discuss the status of its PPA application

3 31. On May 30, 2017, PGE denied Skyward Solar's request for a meeting by
4 email, and notified Skyward Solar that PGE intended to proceed under the normal
5 Schedule 201 process, pursuant to PGE's May 25 email.

6 32. On May 30, 2017, Skyward Solar replied asking if PGE intended to honor
7 the currently available Schedule 201 rates if PGE did not send execution copies until
8 June.

9 33. Skyward Solar's May 30, 2017 reply indicated that Skyward Solar
10 understood its revisions requested on May 23 and revised on May 26 to be minor, and
11 asked PGE to indicate if those revisions were delaying PGE's provision of an executable
12 PPA. Skyward Solar requested PGE provide an executable PPA by May 31.

13 34. Skyward Solar's May 30, 2017 reply also requested a meeting with PGE
14 on either May 30 or 31, if PGE anticipated that it would not be willing to provide
15 Skyward Solar with the current rates under Schedule 201.

16 35. On May 31, 2017, PGE sent Skyward Solar an email confirming that PGE
17 did not anticipate executing a contract with Skyward Solar before June 1, 2017, at which
18 point PGE's avoided cost rates would change.

19 36. PGE's May 31 email stated that Skyward Solar would be eligible for
20 prices at the time its PPAs were executed, and that Skyward was not eligible for PGE's
21 current prices.

1 37. On May 31, 2017, Skyward Solar executed the draft PPA with the two
2 minor alterations previously requested on May 26. Attachment A to this Complaint is a
3 true and correct copy of this partially executed PPA.

4 38. On June 14, 2017, PGE responded by proving a final draft PPA to
5 Skyward Solar.

6 39. PGE's June 14 letter incorrectly stated that Skyward Solar requested six
7 revisions to PGE's draft Standard PPA instead of the five revisions actually requested on
8 May 23, 2017.

9 40. PGE's June 14 letter explained that PGE was willing to accept two of
10 these changes, and appears to confirm that the changes requested by Skyward Solar on
11 May 23 were not substantive, because PGE responded with a final draft PPA rather than a
12 new draft Standard PPA.

13 41. PGE's June 14 letter did not acknowledge the revised request Skyward
14 Solar sent on May 26, for only two minor updates and excluded anything that Skyward
15 Solar believed may be objectionable to PGE.

16 42. PGE's June 14 letter also did not address the partially-executed PPA,
17 which included the two minor changes requested on May 26, and did not include four of
18 the five changes requested on May 23.

19 43. On June 30, 2017, PGE filed its Request for New Solar QF Limits.

20 44. On June 30, 2017, PGE also filed a Motion for Interim Relief, and
21 requested expedited consideration, asking the relief PGE requested as permanent relief
22 also be granted during while the Commission consider PGE's application. PGE
23 requested the interim relief be effective on June 30, 2017.

1 45. On August 2, 2017, Skyward Solar sent PGE a demand letter requesting
2 that PGE execute the partially executed final PPA or Skyward Solar would file a
3 complaint with the Commission.

4 46. The August 2 letter expressed Skyward Solar's belief that PGE had a
5 legally enforceable obligation to purchase Skyward Solar's full net output at the Pre-June
6 1, Rates and Terms.

7 47. The August 2 letter informed PGE that Skyward Solar was willing to
8 execute the any of the various draft PPAs exchanged, under PGE's previous avoided cost
9 rates.

10 48. On August 2, 2017, PGE informed Skyward Solar that PGE would
11 appreciate it Bottlenose Solar could hold off filing any Complaint with the Commission
12 until PGE's Associate General Counsel returned from vacation the following week.

13 49. PGE's August 2 letter refused to execute the partially executed final PPA.

14 50. PGE's August 2 letter refused to execute any of the other other draft PPAs
15 exchanged, under PGE's previous avoided cost rates.

16 VII. LEGAL CLAIMS

17 Complainant's First Claim for Relief

18 **Skyward Solar is entitled to PGE's standard contract at the Pre-June 1 Rates and**
19 **Terms because Skyward Solar legally obligated itself to sell the net output prior to**
20 **the filing of this Complaint, and before the Schedule 201 rates changed on June 1,**
21 **2017**

22
23 51. Skyward Solar re-alleges all the preceding paragraphs.

24 52. PGE has an obligation to purchase a QF's net output that is directly or
25 indirectly made available to PGE. 18 CFR 292.303(a)&(d), 292.304(d); ORS
26 758.525(2)(b), 758.535(2)(a)&3(b); OAR 860-029-0030(1).

1 53. PGE has an obligation to purchase the net output of a QF pursuant to
2 either a contract or a legally enforceable obligation. 18 CFR 292.304(d); Order No. 69,
3 FERC Stats. & Regs. ¶ 30,128, 45 Fed. Reg. 12,214 at 12,219-20, 12,224 (1980). A
4 legally enforceable obligation is broader than a simple contract between an electric utility
5 and a QF, and may exist without a contract. FLS Energy, 157 FERC ¶ 61,211 at PP 24,
6 26; Grouse Creek, LLC, 142 FERC ¶ 61,187 at P 38 (2013).

7 54. The establishment of a legally enforceable obligation turns on the QF's
8 commitment to sell its net output to the electric utility. FLS Energy, 157 FERC ¶ 61,211
9 at P 24; JD Wind 1, LLC, 129 FERC ¶ 61,148, at P 25 (2009). A QF can establish a
10 legally enforceable obligation by committing itself to sell power to an electric utility.
11 FLS Energy, 157 FERC ¶ 61,211 at P 25; Cedar Creek Wind, LLC, 137 FERC ¶ 61,006
12 at PP 36, 39 (2011); Snow Mountain, 734 P.2d at 1371.

13 55. A QF can require a utility to purchase its net output, even if the utility has
14 refused to enter into a contract. Id. at 1370-71; FLS Energy, 157 FERC ¶ 61,211 at P 24;
15 Murphy Flat Power, 141 FERC ¶ 61,145 at P 24 (2012); Grouse Creek, 142 FERC ¶
16 61,187 at P 38. A utility cannot refuse to sign a contract “so that a later and lower
17 avoided cost is applicable.” FLS Energy, 157 FERC ¶ 61,211 at P 25; Cedar Creek
18 Wind, 137 FERC ¶ 61,006 at P 36. Similarly, a QF cannot be required to tender an
19 executed interconnection agreement to form a legally enforceable obligation because that
20 requirement would allow “the utility to control whether and when a legally enforceable
21 obligation exists.” FLS Energy, 157 FERC ¶ 61,211 at PP 23, 26.

22 56. The Commission has confirmed the process for obtaining a PPA: “(1) a
23 QF initiates the process by submitting certain information, the utilities then have 15 days

1 to provide a draft standard contract; (2) the QF may agree to the terms of the draft
2 contract and ask the utility to provide a final executable contract, or suggest changes; (3)
3 the utility provides iterations of the draft standard contract no later than 15 days after
4 each round of comments by the negotiating QF; and (4) when the QF indicates that it
5 agrees to all the terms in the draft contract, the utility has 15 days to forward a final
6 executable contract to the QF.” Re Investigation Into QF Contracting and Pricing,
7 Docket No. UM 1610, Order No. 16-174 at 24 (May 13, 2016). Thus, when the QF
8 informs PGE that it has agreed to all terms and conditions in the draft PPA, PGE is
9 required to provide an executable PPA to the QF.

10 57. The Commission has determined a legally enforceable obligation will be
11 established “once a QF signs the final draft of an executable contract provided by a utility
12 to commit itself to sell power to the utility.” Re Investigation Into QF Contracting and
13 Pricing, Docket No. UM 1610, Order No. 16-174 at 3 (May 13, 2016). However, a
14 legally enforceable obligation “may be established earlier if a QF demonstrates delay or
15 obstruction of progress towards a final draft of an executable contract, such as a failure
16 by a utility to provide a QF with required information or documents on a timely basis.”
17 Id. This is exactly what has occurred in this case.

18 58. The Commission has determined that a PPA can be executed and a legally
19 enforceable obligation can be created in less than two months. Re Investigation Into QF
20 Contracting and Pricing, Docket No. UM 1610, Order No. 16-174 at 24, 27-28 (May 13,
21 2016).

1 59. FERC has determined that a legally enforceable obligation can be created
2 in about one month. Rainbow Ranch Wind, LLC, 139 FERC ¶ 61,077 at PP 2-5, 24
3 (2012); Grouse Creek Wind Park, LLC, 142 FERC ¶ 61,187, at PP 37-43 (2013).

4 60. Skyward Solar has continued to commit, and is still committing, itself to
5 sell the net output of the Skyward Solar project to PGE at the Pre-June 1 Rates and
6 Terms, as set forth in the partially executed final PPA. These commitments include, but
7 are not limited to Skyward Solar's execution of the draft PPA on May 31, 2017 and
8 Skyward Solar's Demand Letter on August 2, 2017.

9 61. Skyward Solar has continued to commit, and is still committing itself to
10 sell its net output to PGE at the Schedule 201 rates, terms, and conditions in the partially
11 executed final PPA.

12 62. PGE is required to purchase the net output of the Skyward Solar project at
13 the Pre-June 1 Rates and Terms set forth in the partially executed final PPA, despite
14 PGE's refusal to execute the partially executed PPA.

15 63. Skyward Solar's repeated statements of commitment to PGE, execution of
16 the executable final PPA, continuing commitment to sell the net output of the Skyward
17 Solar project, and efforts to obtain PGE's execution of the partially executed PPA
18 establish a legally enforceable obligation at the Pre-June 1 Rates and Terms, and all the
19 terms and conditions in the partially executed PPA.

1 **Complainant's Second Claim for Relief**

2 **Skyward Solar is entitled to PGE's standard contract at the Pre-June 1 Rates and**
3 **Terms because Skyward Solar legally obligated itself to sell the net output prior to**
4 **the filing of this Complaint, before the Schedule 201 rates changed on June 1, 2017,**
5 **and PGE violated the OPUC's and FERC's policies and rules, and Schedule 201**
6

7 64. Skyward Solar re-alleges all the preceding paragraphs.

8 65. The Commission has established rules, policies, standard contracts, and
9 rate schedules to facilitate and direct the process by which a QF and an Oregon electric
10 utility enter into a contract. Re Investigation Relating to Electric Utility Purchases from
11 QFs, Docket No. UM 1129, Order No. 05-584 at 6-12, 16 (May 13, 2005). The purpose
12 of the Commission approving standard contracts and schedules for each utility is to pre-
13 establish "rates, terms and conditions that an eligible QF can elect without any
14 negotiation with the purchasing utility" and to "eliminate negotiations" Id. at 12, 16.

15 66. PGE's failure to abide by the terms of the Commission's rules and
16 policies, FERC's rules and policies, and/or Schedule 201 can result in the creation of a
17 legally enforceable obligation. Docket No. UM 1610, Order No. 16-174 at 3; Snow
18 Mountain, 734 P.2d at 1371; International Paper v. PacifiCorp, Docket No. UM 1449,
19 Order No. 09-439 at 6 (Nov. 4, 2009).

20 67. The Commission's polices include that, "when the QF indicates that it
21 agrees to all the terms in the draft contract, the utility has 15 days to forward a final
22 executable contract to the QF." Re Investigation Into QF Contracting and Pricing,
23 Docket No. UM 1610, Order No. 16-174 at 24 (May 13, 2016).

24 68. PGE's Schedule 201 includes timelines and requirements that a utility
25 should follow when entering into a PPA with a QF 10 MWs and under. Pursuant to
26 Schedule 201, "When all information required in the Standard PPA has been received in

1 writing from the Seller, the Company will respond within 15 business days with a draft
2 Standard PPA.”

3 69. Schedule 201 also provides: “When both parties are in full agreement as to
4 all terms and conditions of the draft Standard PPA, the Company will prepare and
5 forward to the Seller a final executable version of the agreement within 15 business
6 days.”

7 70. The Commission’s rules and policies prevent a utility from delaying or
8 obstructing “progress towards a final draft of executable contract”. Re Investigation Into
9 QF Contracting and Pricing, Docket No. UM 1610, Order No. 16-174 at 27-28 (May 13,
10 2016).

11 71. The Commission’s rules and policies were to consider the utilities’ May 1
12 Update at the last Public Meeting in June. See Re Portland General Electric Company
13 Application to Update Schedule 201 Qualifying Facility Information, Docket No. UM
14 1728, REC Comments at 6-7 (May 15, 2017); Re Portland General Electric Company
15 Updates Qualifying Facilities Avoided Cost Payments, Schedule 201, UM 1728, Special
16 Public Meeting beginning at 5:58 (May 18, 2017).

17 72. PGE’s previous May 1 Update filings confirm the Commission’s policy.
18 In 2016, PGE requested an effective date of June 22, 2016, noting “Order No. 14-058
19 directs the annual avoided cost update to be presented at a public meeting and have rates
20 effective within 60 days of the May 1 filing. The last public meeting within 60 days of
21 May 1 is on June 21, 2016; hence the Company requests an effective date of June 22,
22 2016.” Re Portland General Electric Company Application to Update Schedule 201
23 Qualifying Facility Information, Docket No. UM 1728, PGE’s Application at 1 (April 29,

1 2016). In 2015, after debate and clarification about when the May 1 Update should go
2 into effect, PGE ultimately requested an effective date of June 30, 2015. Re Portland
3 General Electric Company Application to Update Schedule 201 Qualifying Facility
4 Information, Docket No. UM 1728, PGE's Revised Application at 1 (June 29, 2015).

5 73. Based upon the Commission's rules and policies, and PGE's pattern of
6 practice adhering to those policies, QFs had a reasonable expectation that the May 1
7 Update would take effect in late June.

8 74. PGE's request to deviate from the Commission's policies and their own
9 practice and hasten the effective date of its May 1 Update resulted in the establishment of
10 a legally enforceable obligation because PGE sought to control when a legally
11 enforceable obligation existed and delay progress toward a final executable contract so
12 that a lower avoided cost rate was applicable. By no later than May 26, 2017, Skyward
13 Solar and PGE had agreed to all material terms and conditions, and Skyward Solar
14 requested an executable version of the PPA.

15 75. PGE has not provided an executable version on the PPA.

16 76. PGE violated Commission rules and policies, FERC's rules and policies,
17 and Schedule 201 when PGE ignored Skyward Solar's executed PPA of May 31, and
18 provided a final draft PPA responsive to Skyward Solar's May 23 request instead.

19 77. By refusing to execute a PPA, PGE has attempted to control whether and
20 when a legally enforceable obligation exists to sell its net output at the currently effective
21 Schedule 201 rates, by delaying negotiations.

1 78. PGE violated the Commission’s rules and policies, FERC’s rules and
2 policies, and Schedule 201 when it delayed and obstructed progress toward executing
3 PPA.

4 79. PGE violated the Commission’s rules and policies, FERC’s rules and
5 policies, and Schedule 201 when it refused to provide an executable PPA or to execute
6 the draft PPA.

7 80. PGE’s violations of the Commission’s rules and policies, FERC’s rules
8 and policies, and Schedule 201, and Skyward Solar’s execution of the draft PPA,
9 continuing commitment to sell the net output of the Skyward Solar project, and efforts to
10 obtain PGE’s signature resulted in a legally enforceable obligation at the previously
11 effective Schedule 201 rates, and all the terms and conditions in the partially executed
12 PPA.

13 **Complainant’s Third Claim for Relief**

14 **Skyward Solar is entitled to PGE’s standard contract at the Pre-June 1 Rates and**
15 **Terms because Skyward Solar legally obligated itself to sell the net output prior to**
16 **the filing of this Complaint, before the Schedule 201 rates changed on June 1, 2017,**
17 **and the Commission cannot changes policies and rules, and Schedule 201 to prevent**
18 **Skyward Solar from obtaining a legally enforceable obligation**
19

20 81. Skyward Solar re-alleges all the preceding paragraphs.

21 82. The Commission cannot revise its own rules or policies to lower the size
22 threshold, impose an ownership cap, adopt an early avoided cost rate reduction, or make
23 other changes in a manner that effectively prevents a qualifying facility from committing
24 itself to sell the net output of its project or otherwise creating a legally enforceable
25 obligation.

1 83. The Commission's cannot changes policies and practices to hasten the
2 effective date of its May 1 Update to prevent the establishment of a legally enforceable
3 obligation because the Commission cannot control when a legally enforceable obligation
4 existed and delay progress toward a final executable contract so that a lower avoided cost
5 rate was applicable.

6 84. The Commission's actions allowing PGE to shorten the time available to
7 QFs to conclude their negotiations with PGE before the effective date of its May 1
8 Update resulted in the establishment of a legally enforceable obligation, because it
9 allowed PGE to delay progress toward a final executable contract so that a lower avoided
10 cost rate was applicable.

11 85. Skyward Solar's execution of the draft PPA, continuing commitment to
12 sell the net output of the Skyward Solar project, and efforts to obtain PGE's signature
13 resulted in a legally enforceable obligation at the previously effective Schedule 201 rates,
14 and all the terms and conditions in the partially executed PPA, despite the Commission
15 allowing the May 1 Update to change rates on June 1, 2017.

16

1 **VIII. PRAYER FOR RELIEF**

2 WHEREFORE, Skyward Solar respectfully requests the Commission issue an
3 order:

- 4 1. Finding PGE in violation of: 1) the mandatory purchase obligation of the Oregon
5 PURPA; 2) the mandatory purchase obligation of the federal PURPA; 3) FERC's
6 PURPA regulations, policies, and orders; 4) the Commission's PURPA
7 regulations, policies, and orders; and 5) PGE's Schedule 201;
- 8 2. Requiring PGE to purchase the net output of the Skyward Solar project at the Pre-
9 June 1 Rates and Term, and all the terms and conditions in the partially executed
10 PPA;
- 11 3. Requiring PGE to enter into a PURPA PPA with Skyward Solar at the Pre-June 1
12 Rates and Term, and all the terms and conditions in the partially executed PPA;
- 13 4. Instituting penalties up to \$10,000 under ORS 756.990 against PGE and paid by
14 PGE's shareholders for each violation of ORS 758.525(2), 758.535(2)(b), 18 CFR
15 292.303(a), 292.304(d), and Commission Order Nos. 05-584 and 16-174.
- 16 5. Granting any other such relief as the Commission deems necessary.

Dated this 7th day of August, 2017.

Respectfully submitted,

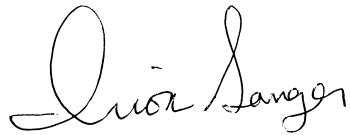
A handwritten signature in cursive script that reads "Irion Sanger".

Irion A. Sanger
Sidney Villanueva
Sanger Law, PC
1117 SE 53rd Avenue
Portland, OR 97215
Telephone: 503-756-7533
Fax: 503-334-2235
irion@sanger-law.com

Of Attorneys for Skyward Solar

CERTIFICATE OF FILING

I certify that on August 7, 2017, on behalf of Skyward Solar, I filed the foregoing Complaint with the Oregon Public Utility Commission by electronic communication consistent with OAR 860-001-0170.

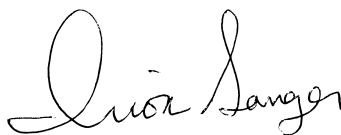

Irion Sanger
Sanger Law, PC
1117 SE 53rd Avenue
Portland, OR 97215
Telephone: 503-756-7533
Fax: 503-334-2235
irion@sanger-law.com

Attachment A

Skyward Solar

Power Purchase Agreement

STANDARD RENEWABLE IN-SYSTEM VARIABLE POWER PURCHASE

AGREEMENT

THIS AGREEMENT is between **Skyward Solar, LLC** ("Seller") and Portland General Electric Company ("PGE") (hereinafter each a "Party" or collectively, "Parties") and is effective upon execution by both Parties ("Effective Date").

RECITALS

Seller intends to construct, own, operate and maintain a **Solar PV** facility for the generation of electric power located in **Clackamas County**

45.419, -122.277 County, Oregon, with a Nameplate Capacity Rating of **2250** kilowatt ("kW"), as further described in Exhibit A ("Facility"); and

Seller intends to operate the Facility as a "Qualifying Facility," as such term is defined in Section 3.1.3, below.

Seller shall sell and PGE shall purchase the entire Net Output, as such term is defined in Section 1.21, below, from the Facility in accordance with the terms and conditions of this Agreement.

AGREEMENT

NOW, THEREFORE, the Parties mutually agree as follows:

SECTION 1: DEFINITIONS

When used in this Agreement, the following terms shall have the following meanings:

1.1. "As-built Supplement" means the supplement to Exhibit A provided by Seller in accordance with Section 4.3 following completion of construction of the Facility, describing the Facility as actually built.

1.2. "Base Hours" is defined as the total number of hours in each Contract Year (8,760 or 8,784 for leap year).

1.3. "Billing Period" means a period between PGE's readings of its power purchase billing meter at the Facility in the normal course of PGE's business. Such periods may vary and may not coincide with calendar months; however, PGE shall use best efforts to read the power purchase billing meter in 12 equally spaced periods per year.

1.4. "Cash Escrow" means an agreement by two parties to place money into the custody of a third party for delivery to a grantee only after the fulfillment of the conditions specified.

1.5. "Commercial Operation Date" means the date that the Facility is deemed by PGE to be fully operational and reliable. PGE may, at its discretion, require, among other things, that all of the following events have occurred:

1.5.1. (facilities with nameplate under 500 kW exempt from following requirement) PGE has received a certificate addressed to PGE from a Licensed Professional Engineer ("LPE") acceptable to PGE in its reasonable judgment stating that the Facility is able to generate electric power reliably in accordance with the terms and conditions of this Agreement (certifications required under this Section 1.5 can be provided by one or more LPEs);

1.5.2. Start-Up Testing of the Facility has been completed in accordance with Section 1.36;

1.5.3. (facilities with nameplate under 500 kW exempt from following requirement) After PGE has received notice of completion of Start-Up Testing, PGE has received a certificate addressed to PGE from an LPE stating that the Facility has operated for testing purposes under this Agreement and was continuously mechanically available for operation for a minimum of 120 hours. The Facility must provide ten (10) working days written notice to PGE prior to the start of the initial testing period. If the mechanical availability of the Facility is interrupted during this initial testing period or any subsequent testing period, the Facility shall promptly start a new Test Period and provide PGE forty-eight (48) hours written notice prior to the start of such testing period;

1.5.4. (facilities with nameplate under 500 kW exempt from following requirement) PGE has received a certificate addressed to PGE from an LPE stating that in accordance with the Generation Interconnection Agreement, all required interconnection facilities have been constructed all required interconnection tests have been completed; and the Facility is physically interconnected with PGE's electric system.

1.5.5. (facilities with nameplate under 500kW exempt from following requirement) PGE has received a certificate addressed to PGE from an LPE stating that Seller has obtained all Required Facility Documents and, if requested by PGE in writing, has provided copies of any or all such requested Required Facility Documents;

1.6. "Contract Price" means the applicable price, including on-peak and off-peak prices, as specified in the Schedule.

1.7. "Contract Year" means each twelve (12) month period commencing upon the Commercial Operation Date or its anniversary during the Term, except the final contract year will be the period from the last anniversary of the Commercial Operation Date during the Term until the end of the Term.

1.8. "Effective Date" has the meaning set forth in Section 2.1.

1.9. "Environmental Attributes" shall mean any and all claims, credits, benefits, emissions reductions, offsets, and allowances, howsoever entitled, resulting from the avoidance of the emission of any gas, chemical or other substance to the air, soil or water. Environmental Attributes include but are not limited to: (1) any avoided

emissions of pollutants to the air, soil or water such as (subject to the foregoing) sulfur oxides (SO_x), nitrogen oxides (NO_x), carbon monoxide (CO), and other pollutants; and (2) any avoided emissions of carbon dioxide (CO₂), methane (CH₄), and other greenhouse gasses (GHGs) that have been determined by the United Nations Intergovernmental Panel on Climate Change to contribute to the actual or potential threat of altering the Earth's climate by trapping heat in the atmosphere.

1.10. "Facility" has the meaning set forth in the Recitals.

1.11. "Generation Interconnection Agreement" means the generation interconnection agreement to be entered into separately between Seller and PGE, providing for the construction, operation, and maintenance of interconnection facilities required to accommodate deliveries of Seller's Net Output.

1.12. "Generation Unit" means each separate electrical generator that contributes towards Nameplate Capacity Rating included in Exhibit A. For solar facilities, a generating unit is a complete solar electrical generation system within the Facility that is able to generate and deliver energy to the Point of Delivery independent of other Generation Units within the same Facility.

1.13. "Letter of Credit" means an engagement by a bank or other person made at the request of a customer that the issuer will honor drafts or other demands for payment upon compliance with the conditions specified in the letter of credit.

1.14. "Licensed Professional Engineer" or "LPE" means a person who is licensed to practice engineering in the state where the Facility is located, who has no economic relationship, association, or nexus with the Seller, and who is not a representative of a consulting engineer, contractor, designer or other individual involved in the development of the Facility, or of a manufacturer or supplier of any equipment installed in the Facility. Such Licensed Professional Engineer shall be licensed in an appropriate engineering discipline for the required certification being made and be acceptable to PGE in its reasonable judgment.

1.15. "Lost Energy" means ((the Guarantee of Mechanical Availability as set forth in 3.1.10 / MAP) X Net Output for a Calendar Year) – Net Output for the Calendar Year. Lost Energy shall be zero unless the result of the calculation in this subsection results in a positive number.

1.16. "Lost Energy Value" means Lost Energy X the excess of the annual time-weighted average Mid-C Index Price for On-Peak and Off-Peak Hours over the time-weighted average Contract Price for On-Peak and Off-Peak Hours for the corresponding time period (provided that such excess shall not exceed the Contract Price and further provided that Lost Energy is deemed to be zero prior to reaching the Commercial Operation Date) plus any reasonable costs incurred by PGE to purchase replacement power and/or transmission to deliver the replacement power to the Point of Delivery. (For Start-Up Lost Energy Value see Section 1.35).

1.17. "Mechanical Availability Percentage" or "MAP" shall mean that percentage for any Contract Year for the Facility calculated in accordance with the following formula:

$$\text{MAP} = 100 \times (\text{Operational Hours}) / (\text{Base Hours} \times \text{Number of Units})$$

1.18. "Mid-C Index Price" means the Day Ahead Intercontinental Exchange ("ICE") index price for the bilateral OTC market for energy at the Mid-C Physical for Average On Peak Power and Average Off Peak Power found on the following website: <https://www.theice.com/products/OTC/Physical-Energy/Electricity>. In the event ICE no longer publishes this index, PGE and the Seller agree to select an alternative successor index representative of the Mid-C trading hub.

1.19. "Nameplate Capacity Rating" means the maximum capacity of the Facility as stated by the manufacturer, expressed in kW, which shall not exceed 10,000 kW.

1.20. "Net Dependable Capacity" means the maximum capacity the Facility can sustain over a specified period modified for seasonal limitations, if any, and reduced by the capacity required for station service or auxiliaries.

1.21. "Net Output" means all energy expressed in kWhs produced by the Facility, less station and other onsite use and less transformation and transmission losses. Net Output does not include any environmental attributes.

1.22. "Number of Units" means the number of Generating Units in the Facility described in Exhibit A.

1.23. "Off-Peak Hours" has the meaning provided in the Schedule.

1.24. "On-Peak Hours" has the meaning provided in the Schedule.

1.25. "Operational Hours" for the Facility means the total across all Generating Units of the number of hours each of the Facility's Generating Units are potentially capable of producing power at its Nameplate Capacity Rating regardless of actual weather, season and time of day or night, without any mechanical operating constraint or restriction, and potentially capable of delivering such power to the Point of Delivery in a Contract Year. During up to, but not more than, 200 hours of Planned Maintenance during a Contract Year for each Generation Unit and hours during which an event of Force Majeure exists, a Generation Unit shall be considered potentially capable of delivering such power to the Point of Delivery. For example, in the absence of any Planned Maintenance beyond 200 hours on any Generation Unit of Event of Force Majeure, the Operational Hours for a wind farm with five separate two MW turbines would be 43,800 for a Contract Year.

1.26. "Planned Maintenance" means outages scheduled 90 days in advance, with PGE's prior written consent, which shall not be unreasonably withheld.

1.27. "Point of Delivery" means the high side of the generation step up transformer(s) located at the point of interconnection between the Facility and PGE's distribution or transmission system, as specified in the Generation Interconnection Agreement.

1.28. "Pre-Commercial Operation Date Minimum Net Output" shall mean, unless such MWh is specifically set forth by Seller in Exhibit A, an amount in MWh equal to seventy-five percent (75%) of the Nameplate Capacity Rating X thirty percent (30%) for a wind or other renewable QF or fifty percent (50%) for a solar QF X (whole months since the date selected in Section 2.2.1 / 12) X (8760 hours – 200 hours (assumed Planned Maintenance)) for each month. If Seller has provided specific expected monthly Net Output amounts for the Facility in Exhibit A, "Pre-Commercial Operation Date Minimum Net Output" shall mean seventy-five (75%) X expected Net Output set forth in Exhibit A for each month.

1.29. "Prime Rate" means the publicly announced prime rate or reference rate for commercial loans to large businesses with the highest credit rating in the United States in effect from time to time quoted by Citibank, N.A. If a Citibank, N.A. prime rate is not available, the applicable Prime Rate shall be the announced prime rate or reference rate for commercial loans in effect from time to time quoted by a bank with \$10 billion or more in assets in New York City, N.Y., selected by the Party to whom interest based on the prime rate is being paid.

1.30. "Prudent Electrical Practices" means those practices, methods, standards and acts engaged in or approved by a significant portion of the electric power industry in the Western Electricity Coordinating Council that at the relevant time period, in the exercise of reasonable judgment in light of the facts known or that should reasonably have been known at the time a decision was made, would have been expected to accomplish the desired result in a manner consistent with good business practices, reliability, economy, safety and expedition, and which practices, methods, standards and acts reflect due regard for operation and maintenance standards recommended by applicable equipment suppliers and manufacturers, operational limits, and all applicable laws and regulations. Prudent Electrical Practices are not intended to be limited to the optimum practice, method, standard or act to the exclusion of all others, but rather to those practices, methods and acts generally acceptable or approved by a significant portion of the electric power generation industry in the relevant region, during the relevant period, as described in the immediate preceding sentence.

1.31. "Required Facility Documents" means all licenses, permits, authorizations, and agreements necessary for construction, operation, interconnection, and maintenance of the Facility including without limitation those set forth in Exhibit B.

1.32. "RPS Attributes" means all attributes related to the Net Output generated by the Facility that are required in order to provide PGE with "qualifying electricity," as that term is defined in Oregon's Renewable Portfolio Standard Act, Ore. Rev. Stat. 469A.010, in effect at the time of execution of this Agreement. RPS Attributes do not include Environmental Attributes that are greenhouse gas offsets from methane capture not associated with the generation of electricity and not needed to ensure that there are zero net emissions associated with the generation of electricity.

1.33. "Schedule" shall mean PGE Schedule 201 filed with the Oregon Public Utilities Commission ("Commission") in effect on the Effective Date of this Agreement

and attached hereto as Exhibit D, the terms of which are hereby incorporated by reference.

1.34. "Senior Lien" means a prior lien which has precedence as to the property under the lien over another lien or encumbrance.

1.35. "Start-Up Lost Energy Value" means for the period after the date specified in Section 2.2.2 but prior to achievement of the Commercial Operation Date: zero, unless the Net Output is less than the pro-rated Pre-Commercial Operation Date Minimum Net Output for the applicable delay period, and the time-weighted average of the delay period's Mid-C Index Price for On-Peak Hours and Off-Peak Hours is greater than the time-weighted average of the delay period's Contract Price for On-Peak Hours and Off-Peak Hours, in which case Startup Lost Energy Value equals: (pro-rated Pre-Commercial Operation Date Minimum Net Output for the applicable period - Net Output for the applicable period) X (the lower of: the time-weighted average of the Contract Price for On-Peak hours and Off-Peak Hours during the applicable period; or (the time-weighted average of the Mid-C Index Price for On-Peak Hours and Off-Peak Hours during the applicable period – the time-weighted average of the Contract Price for On-Peak Hours and Off-Peak Hours during the applicable period)). The time-weighted average in this section will reflect the relative proportions of On-Peak Hours and Off-Peak Hours in each day.

1.36. "Start-Up Testing" means the completion of applicable required factory and start-up tests as set forth in Exhibit C.

1.37. "Step-in Rights" means the right of one party to assume an intervening position to satisfy all terms of an agreement in the event the other party fails to perform its obligations under the agreement.

1.38. "Term" shall mean the period beginning on the Effective Date and ending on the Termination Date.

1.39. "Test Period" shall mean a period of sixty (60) days or a commercially reasonable period determined by the Seller.

References to Recitals, Sections, and Exhibits are to be the recitals, sections and exhibits of this Agreement.

SECTION 2: TERM; COMMERCIAL OPERATION DATE

2.1. This Agreement shall become effective upon execution by both Parties ("Effective Date").

2.2. Time is of the essence of this Agreement, and Seller's ability to meet certain requirements prior to the Commercial Operation Date and to complete all requirements to establish the Commercial Operation Date is critically important. Therefore,

2.2.1 By **5/1/2020 Seller shall** begin initial deliveries of Net Output; and

2.2.2 By **5/1/2020 Seller shall** have completed all requirements under Section 1.5 and shall have established the Commercial Operation Date.

2.2.3 Unless the Parties agree in writing that a later Commercial Operation Date is reasonable and necessary, the Commercial Operation Date shall be no more than three (3) years from the Effective Date. PGE will not unreasonably withhold agreement to a Commercial Operation Date that is more than three (3) years from the Effective date if the Seller has demonstrated that a later Commercial Operation Date is reasonable and necessary.

2.3. This Agreement shall terminate **20 years from Effective Date of Agreement**, or the date the Agreement is terminated in accordance with Section 9 or 11, whichever is earlier ("Termination Date").

SECTION 3: REPRESENTATIONS AND WARRANTIES

3.1. Seller and PGE represent, covenant, and warrant as follows:

3.1.1. Seller warrants it is a **Limited Liability Company** duly organized under the laws of **Oregon**.

3.1.2. Seller warrants that the execution and delivery of this Agreement does not contravene any provision of, or constitute a default under, any indenture, mortgage, or other material agreement binding on Seller or any valid order of any court, or any regulatory agency or other body having authority to which Seller is subject.

3.1.3. Seller warrants that the Facility is and shall for the Term of this Agreement continue to be a "Qualifying Facility" ("QF") as that term is defined in the version of 18 C.F.R. Part 292 in effect on the Effective Date. Seller has provided the appropriate QF certification, which may include a Federal Energy Regulatory Commission ("FERC") self-certification to PGE prior to PGE's execution of this Agreement. At any time during the Term of this Agreement, PGE may require Seller to provide PGE with evidence satisfactory to PGE in its reasonable discretion that the Facility continues to qualify as a QF under all applicable requirements.

3.1.4. Seller warrants that it has not within the past two (2) years been the debtor in any bankruptcy proceeding, and Seller is and will continue to be for the Term of this Agreement current on all of its financial obligations.

3.1.5. Seller warrants that during the Term of this Agreement, all of Seller's right, title and interest in and to the Facility shall be free and clear of all liens and encumbrances other than liens and encumbrances arising from third-party financing of the Facility other than workers', mechanics', suppliers' or similar liens, or tax liens, in each case arising in the ordinary course of business that are either not yet due and payable or that have been released by means of a performance bond acceptable to PGE posted within eight (8) calendar days of the commencement of any proceeding to foreclose the lien.

3.1.6. Seller warrants that it will design and operate the Facility consistent with Prudent Electrical Practices.

3.1.7. Seller warrants that the Facility has a Nameplate Capacity Rating not greater than 10,000 kW.

3.1.8. Seller warrants that Net Dependable Capacity of the Facility is **2250** kW.

3.1.9. Seller estimates that the average annual Net Output to be delivered by the Facility to PGE is **3,638,546** kilowatt-hours ("kWh"), which amount PGE will include in its resource planning.

3.1.10. Seller represents and warrants that the Facility shall achieve the following Mechanical Availability Percentages ("Guarantee of Mechanical Availability"):

3.1.10.1 Ninety percent (90%) beginning in the first Contract Year and extending through the Term for the Facility, if the Facility was operational and sold electricity to PGE or another buyer prior to the Effective Date of this Agreement; or

3.1.10.2 Ninety percent (90%) beginning in Contract Year three and extending throughout the remainder of the Term.

3.1.10.3 Annually, within 90 days of the end of each Contract Year Seller shall send to PGE a detailed written report demonstrating and providing evidence of the actual MAP for the previous Contract Year.

3.1.10.4 Seller's failure to meet the Guarantee of Mechanical Availability in a Calendar Year shall result in damages payable to PGE by Seller equal to the Lost Energy Value. PGE shall bill Seller for such damages in accordance with Section 8.

3.1.11. Seller will deliver from the Facility to PGE at the Point of Delivery Net Output not to exceed a maximum of **5,298,418 kwh of Net Output during each contract year ("Maximum Net Output")** of Net Output during each Contract Year ("Maximum Net Output").

3.1.12. By the Commercial Operation Date, Seller has entered into a Generation Interconnection Agreement for a term not less than the term of this Agreement.

3.1.13. PGE warrants that it has not within the past two (2) years been the debtor in any bankruptcy proceeding, and PGE is and will continue to be for the Term of this Agreement current on all of its financial obligations.

3.1.14. Seller warrants that (i) the Facility satisfies the eligibility requirements specified in the Definition of a Small Cogeneration Facility or Small Power Production Facility Eligible to Receive the Standard Renewable Rates and Standard Renewable PPA in PGE's Schedule and (ii) Seller will not make any changes in its ownership, control or management during the term of this Agreement that would cause it to not be in compliance with the Definition of a Small Cogeneration Facility or Small Power Production Facility Eligible to Receive the Standard Renewable Rates and Standard Renewable PPA in PGE's Schedule. Seller will provide, upon request by PGE not more frequently than every 36 months, such documentation and information as may be reasonably required to establish Seller's continued compliance with such Definition. PGE agrees to take reasonable steps to maintain the confidentiality of any portion of the above described documentation and information that the Seller identifies as confidential

except PGE will provide all such confidential information to the Public Utility Commission of Oregon upon the Commission's request.

3.1.15. Seller warrants that it will comply with all requirements necessary for all Transferred RECs (as defined in Section 4.5) associated with Net Output to be issued, monitored, accounted for, and transferred by and through the Western Renewable Energy Generation System consistent with the provisions of OAR 330-160-0005 through OAR 330-160-0050. PGE warrants that it will reasonably cooperate in Seller's efforts to meet such requirements, including, for example serving as the qualified reporting entity for the Facility if the Facility is located in PGE's balancing authority.

SECTION 4: DELIVERY OF POWER, PRICE AND ENVIRONMENTAL ATTRIBUTES

4.1. Commencing on the Effective Date and continuing through the Term of this Agreement, Seller shall sell to PGE the entire Net Output delivered from the Facility at the Point of Delivery.

4.2. PGE shall pay Seller the Contract Price for all delivered Net Output.

4.3. Upon completion of construction of the Facility, Seller shall provide PGE an As-built Supplement to specify the actual Facility as built. Seller shall not increase the Nameplate Capacity Rating above that specified in Exhibit A or increase the ability of the Facility to deliver Net Output in quantities in excess of the Net Dependable Capacity, or the Maximum Net Output as described in Section 3.1.11 above, through any means including, but not limited to, replacement, modification, or addition of existing equipment, except with prior written notice to PGE. In the event Seller increases the Nameplate Capacity Rating of the Facility to no more than 10,000 kW pursuant to this section, PGE shall pay the Contract Price for the additional delivered Net Output. In the event Seller increases the Nameplate Capacity Rating to greater than 10,000 kW, then Seller shall be required to enter into a new power purchase agreement for all delivered Net Output proportionally related to the increase of Nameplate Capacity above 10,000 kW.

4.4. To the extent not otherwise provided in the Generation Interconnection Agreement, all costs associated with the modifications to PGE's interconnection facilities or electric system occasioned by or related to the interconnection of the Facility with PGE's system, or any increase in generating capability of the Facility, or any increase of delivery of Net Dependable Capacity from the Facility, shall be borne by Seller.

4.5. From the start of the Renewable Resource Deficiency Period through the remainder of the Term of this Agreement, Seller shall provide and PGE shall acquire the RPS Attributes for the Contract Years as specified in the Schedule and Seller shall retain ownership of all other Environmental Attributes (if any). During the Renewable Resource Sufficiency Period, Seller shall retain all Environmental Attributes in accordance with the Schedule. The Contract Price includes full payment for the Net Output and any RPS Attributes transferred to PGE under this Agreement. With respect to Environmental Attributes not transferred to PGE under this Agreement ("Seller-Retained Environmental Attributes") Seller may report under §1605(b) of the Energy

Policy Act of 1992 or under any applicable program as belonging to Seller any of the Seller-Retained Environmental Attributes, and PGE shall not report under such program that such Seller-Retained Environmental Attributes belong to it. With respect to RPS Attributes transferred to PGE under this Agreement ("Transferred RECs"), PGE may report under §1605(b) of the Energy Policy Act of 1992 or under any applicable program as belonging to it any of the Transferred RECs, and Seller shall not report under such program that such Transferred RECs belong to it.

SECTION 5: OPERATION AND CONTROL

5.1. Seller shall operate and maintain the Facility in a safe manner in accordance with the Generation Interconnection Agreement, and Prudent Electrical Practices. PGE shall have no obligation to purchase Net Output from the Facility to the extent the interconnection of the Facility to PGE's electric system is disconnected, suspended or interrupted, in whole or in part, pursuant to the Generation Interconnection Agreement, or to the extent generation curtailment is required as a result of Seller's noncompliance with the Generation Interconnection Agreement. Seller is solely responsible for the operation and maintenance of the Facility. PGE shall not, by reason of its decision to inspect or not to inspect the Facility, or by any action or inaction taken with respect to any such inspection, assume or be held responsible for any liability or occurrence arising from the operation and maintenance by Seller of the Facility.

5.2. Seller agrees to provide sixty (60) days advance written notice of any scheduled maintenance that would require shut down of the Facility for any period of time.

5.3. If the Facility ceases operation for unscheduled maintenance, Seller immediately shall notify PGE of the necessity of such unscheduled maintenance, the time when such maintenance has occurred or will occur, and the anticipated duration of such maintenance. Seller shall take all reasonable measures and exercise its best efforts to avoid unscheduled maintenance, to limit the duration of such unscheduled maintenance, and to perform unscheduled maintenance during Off-Peak hours.

SECTION 6: CREDITWORTHINESS

In the event Seller: a) is unable to represent or warrant as required by Section 3 that it has not been a debtor in any bankruptcy proceeding within the past two (2) years; b) becomes such a debtor during the Term; or c) is not or will not be current on all its financial obligations, Seller shall immediately notify PGE and shall promptly (and in no less than 10 days after notifying PGE) provide default security in an amount reasonably acceptable to PGE in one of the following forms: Senior Lien, Step-in Rights, a Cash Escrow or Letter of Credit. The amount of such default security that shall be acceptable to PGE shall be equal to: (annual On Peak Hours) X (On Peak Price – Off Peak Price) X (Net Dependable Capacity). Notwithstanding the foregoing, in the event Seller is not current on construction related financial obligations, Seller shall notify PGE of such delinquency and PGE may, in its discretion, grant an exception to the

requirements to provide default security if the QF has negotiated financial arrangements with the construction loan lender that mitigate Seller's financial risk to PGE.

SECTION 7: METERING

7.1. PGE shall design, furnish, install, own, inspect, test, maintain and replace all metering equipment at Seller's cost and as required pursuant to the Generation Interconnection Agreement.

7.2. Metering shall be performed at the location and in a manner consistent with this Agreement and as specified in the Generation Interconnection Agreement. All Net Output purchased hereunder shall be adjusted to account for electrical losses, if any, between the point of metering and the Point of Delivery, so that the purchased amount reflects the net amount of power flowing into PGE's system at the Point of Delivery.

7.3. PGE shall periodically inspect, test, repair and replace the metering equipment as provided in the Generation Interconnection Agreement. If any of the inspections or tests discloses an error exceeding two (2%) percent of the actual energy delivery, either fast or slow, proper correction, based upon the inaccuracy found, shall be made of previous readings for the actual period during which the metering equipment rendered inaccurate measurements if that period can be ascertained. If the actual period cannot be ascertained, the proper correction shall be made to the measurements taken during the time the metering equipment was in service since last tested, but not exceeding three (3) months, in the amount the metering equipment shall have been shown to be in error by such test. Any correction in billings or payments resulting from a correction in the meter records shall be made in the next monthly billing or payment rendered. Such correction, when made, shall constitute full adjustment of any claim between Seller and PGE arising out of such inaccuracy of metering equipment.

7.4. To the extent not otherwise provided in the Generation Interconnection Agreement, all of PGE's costs relating to all metering equipment installed to accommodate Seller's Facility shall be borne by Seller.

SECTION 8: BILLINGS, COMPUTATIONS AND PAYMENTS

8.1. On or before the thirtieth (30th) day following the end of each Billing Period, PGE shall send to Seller payment for Seller's deliveries of Net Output to PGE, together with computations supporting such payment. PGE may offset any such payment to reflect amounts owing from Seller to PGE pursuant to this Agreement, the Generation Interconnection Agreement, and any other agreement related to the Facility between the Parties or otherwise. On or before the thirtieth (30th) day following the end of each Contract Year, PGE shall bill for any Lost Energy Value accrued pursuant to this Agreement.

8.2. Any amounts owing after the due date thereof shall bear interest at the Prime Rate plus two percent (2%) from the date due until paid; provided, however, that the interest rate shall at no time exceed the maximum rate allowed by applicable law.

SECTION 9: DEFAULT, REMEDIES AND TERMINATION

9.1. In addition to any other event that may constitute a default under this Agreement, the following events shall constitute defaults under this Agreement:

9.1.1. Breach by Seller or PGE of a representation or warranty, except for Section 3.1.4, set forth in this Agreement.

9.1.2. Seller's failure to provide default security, if required by Section 6, prior to delivery of any Net Output to PGE or within 10 days of notice.

9.1.3. Seller's failure to meet the Guarantee of Mechanical Availability established in Section 3.1.10 for two consecutive Contract Years or Seller's failure to provide any written report required by that section.

9.1.4. If Seller is no longer a Qualifying Facility.

9.1.5. Failure of PGE to make any required payment pursuant to Section 8.1.

9.1.6. Seller's failure to meet the Commercial Operation Date.

9.2. In the event of a default under Section 9.1.6, PGE may provide Seller with written notice of default. Seller shall have one year in which to cure the default during which time the Seller shall pay PGE damages equal to the Lost Energy Value. If Seller is unable to cure the default, PGE may immediately terminate this Agreement as provided in Section 9.3. PGE's resource sufficiency/deficiency position shall have no bearing on PGE's right to terminate the Agreement under this Section 9.2.

9.3. In the event of a default under this Agreement, except as otherwise provided in this Agreement, the non-defaulting party may immediately terminate this Agreement at its sole discretion by delivering written notice to the other Party. In addition, the non-defaulting party may pursue any and all legal or equitable remedies provided by law or pursuant to this Agreement including damages related to the need to procure replacement power. A termination hereunder shall be effective upon the date of delivery of notice, as provided in Section 20. The rights provided in this Section 9 are cumulative such that the exercise of one or more rights shall not constitute a waiver of any other rights.

9.4. If this Agreement is terminated as provided in this Section 9 PGE shall make all payments, within thirty (30) days, that, pursuant to the terms of this Agreement, are owed to Seller as of the time of receipt of notice of default. PGE shall not be required to pay Seller for any Net Output delivered by Seller after such notice of default.

9.5. In the event PGE terminates this Agreement pursuant to this Section 9, and Seller wishes to again sell Net Output to PGE following such termination, PGE in its sole discretion may require that Seller shall do so subject to the terms of this Agreement, including but not limited to the Contract Price until the Term of this Agreement (as set forth in Section 2.3) would have run in due course had the Agreement remained in effect. At such time Seller and PGE agree to execute a written document ratifying the terms of this Agreement.

9.6. Sections 9.1, 9.4, 9.5, 10, and 19.2 shall survive termination of this Agreement.

SECTION 10: INDEMNIFICATION AND LIABILITY

10.1. Seller agrees to defend, indemnify and hold harmless PGE, its directors, officers, agents, and representatives against and from any and all loss, claims, actions or suits, including costs and attorney's fees, both at trial and on appeal, resulting from, or arising out of or in any way connected with Seller's delivery of electric power to PGE or with the facilities at or prior to the Point of Delivery, or otherwise arising out of this Agreement, including without limitation any loss, claim, action or suit, for or on account of injury, bodily or otherwise, to, or death of, persons, or for damage to, or destruction or economic loss of property belonging to PGE, Seller or others, excepting to the extent such loss, claim, action or suit may be caused by the negligence of PGE, its directors, officers, employees, agents or representatives.

10.2. PGE agrees to defend, indemnify and hold harmless Seller, its directors, officers, agents, and representatives against and from any and all loss, claims, actions or suits, including costs and attorney's fees, both at trial and on appeal, resulting from, or arising out of or in any way connected with PGE's receipt of electric power from Seller or with the facilities at or after the Point of Delivery, or otherwise arising out of this Agreement, including without limitation any loss, claim, action or suit, for or on account of injury, bodily or otherwise, to, or death of, persons, or for damage to, or destruction or economic loss of property belonging to PGE, Seller or others, excepting to the extent such loss, claim, action or suit may be caused by the negligence of Seller, its directors, officers, employees, agents or representatives.

10.3. Nothing in this Agreement shall be construed to create any duty to, any standard of care with reference to, or any liability to any person not a Party to this Agreement. No undertaking by one Party to the other under any provision of this Agreement shall constitute the dedication of that Party's system or any portion thereof to the other Party or to the public, nor affect the status of PGE as an independent public utility corporation or Seller as an independent individual or entity.

10.4. NEITHER PARTY SHALL BE LIABLE TO THE OTHER FOR SPECIAL, PUNITIVE, INDIRECT OR CONSEQUENTIAL DAMAGES, WHETHER ARISING FROM CONTRACT, TORT (INCLUDING NEGLIGENCE), STRICT LIABILITY OR OTHERWISE.

SECTION 11: INSURANCE

11.1. Prior to the connection of the Facility to PGE's electric system, provided such Facility has a design capacity of 200 kW or more, Seller shall secure and continuously carry for the Term hereof, with an insurance company or companies rated not lower than "B+" by the A. M. Best Company, insurance policies for bodily injury and property damage liability. Such insurance shall include provisions or endorsements naming PGE, its directors, officers and employees as additional insureds; provisions that such insurance is primary insurance with respect to the interest of PGE and that any insurance or self-insurance maintained by PGE is excess and not contributory insurance with the insurance required hereunder; a cross-liability or severability of insurance interest clause; and provisions that such policies shall not be canceled or

their limits of liability reduced without thirty (30) days' prior written notice to PGE. Initial limits of liability for all requirements under this section shall be \$1,000,000 million single limit, which limits may be required to be increased or decreased by PGE as PGE determines in its reasonable judgment economic conditions or claims experience may warrant.

11.2. Prior to the connection of the Facility to PGE's electric system, provided such facility has a design capacity of 200 kW or more, Seller shall secure and continuously carry for the Term hereof, in an insurance company or companies rated not lower than "B+" by the A. M. Best Company, insurance acceptable to PGE against property damage or destruction in an amount not less than the cost of replacement of the Facility. Seller promptly shall notify PGE of any loss or damage to the Facility. Unless the Parties agree otherwise, Seller shall repair or replace the damaged or destroyed Facility, or if the facility is destroyed or substantially destroyed, it may terminate this Agreement. Such termination shall be effective upon receipt by PGE of written notice from Seller. Seller shall waive its insurers' rights of subrogation against PGE regarding Facility property losses.

11.3. Prior to the connection of the Facility to PGE's electric system and at all other times such insurance policies are renewed or changed, Seller shall provide PGE with a copy of each insurance policy required under this Section, certified as a true copy by an authorized representative of the issuing insurance company or, at the discretion of PGE, in lieu thereof, a certificate in a form satisfactory to PGE certifying the issuance of such insurance. If Seller fails to provide PGE with copies of such currently effective insurance policies or certificates of insurance, PGE at its sole discretion and without limitation of other remedies, may upon ten (10) days advance written notice by certified or registered mail to Seller either withhold payments due Seller until PGE has received such documents, or purchase the satisfactory insurance and offset the cost of obtaining such insurance from subsequent power purchase payments under this Agreement.

SECTION 12: FORCE MAJEURE

12.1. As used in this Agreement, "Force Majeure" or "an event of Force Majeure" means any cause beyond the reasonable control of the Seller or of PGE which, despite the exercise of due diligence, such Party is unable to prevent or overcome. By way of example, Force Majeure may include but is not limited to acts of God, fire, flood, storms, wars, hostilities, civil strife, strikes, and other labor disturbances, earthquakes, fires, lightning, epidemics, sabotage, restraint by court order or other delay or failure in the performance as a result of any action or inaction on behalf of a public authority which by the exercise of reasonable foresight such Party could not reasonably have been expected to avoid and by the exercise of due diligence, it shall be unable to overcome, subject, in each case, to the requirements of the first sentence of this paragraph. Force Majeure, however, specifically excludes the cost or availability of resources to operate the Facility, changes in market conditions that affect the price of energy or transmission, wind or water droughts, and obligations for the payment of money when due.

12.2. If either Party is rendered wholly or in part unable to perform its obligation under this Agreement because of an event of Force Majeure, that Party shall be excused from whatever performance is affected by the event of Force Majeure to the extent and for the duration of the Force Majeure, after which such Party shall recommence performance of such obligation, provided that:

12.2.1. the non-performing Party shall, promptly, but in any case within one (1) week after the occurrence of the Force Majeure, give the other Party written notice describing the particulars of the occurrence; and

12.2.2. the suspension of performance shall be of no greater scope and of no longer duration than is required by the Force Majeure; and

12.2.3. the non-performing Party uses its best efforts to remedy its inability to perform its obligations under this Agreement.

12.3. No obligations of either Party which arose before the Force Majeure causing the suspension of performance shall be excused as a result of the Force Majeure.

12.4. Neither Party shall be required to settle any strike, walkout, lockout or other labor dispute on terms which, in the sole judgment of the Party involved in the dispute, are contrary to the Party's best interests.

SECTION 13: SEVERAL OBLIGATIONS

Nothing contained in this Agreement shall ever be construed to create an association, trust, partnership or joint venture or to impose a trust or partnership duty, obligation or liability between the Parties. If Seller includes two or more parties, each such party shall be jointly and severally liable for Seller's obligations under this Agreement.

SECTION 14: CHOICE OF LAW

This Agreement shall be interpreted and enforced in accordance with the laws of the state of Oregon, excluding any choice of law rules which may direct the application of the laws of another jurisdiction.

SECTION 15: PARTIAL INVALIDITY AND PURPA REPEAL

It is not the intention of the Parties to violate any laws governing the subject matter of this Agreement. If any of the terms of the Agreement are finally held or determined to be invalid, illegal or void as being contrary to any applicable law or public policy, all other terms of the Agreement shall remain in effect. If any terms are finally held or determined to be invalid, illegal or void, the Parties shall enter into negotiations concerning the terms affected by such decision for the purpose of achieving conformity with requirements of any applicable law and the intent of the Parties to this Agreement.

In the event the Public Utility Regulatory Policies Act (PURPA) is repealed, this Agreement shall not terminate prior to the Termination Date, unless such termination is mandated by state or federal law.

SECTION 16: WAIVER

Any waiver at any time by either Party of its rights with respect to a default under this Agreement or with respect to any other matters arising in connection with this Agreement must be in writing, and such waiver shall not be deemed a waiver with respect to any subsequent default or other matter.

SECTION 17: GOVERNMENTAL JURISDICTION AND AUTHORIZATIONS

This Agreement is subject to the jurisdiction of those governmental agencies having control over either Party or this Agreement. Seller shall at all times maintain in effect all local, state and federal licenses, permits and other approvals as then may be required by law for the construction, operation and maintenance of the Facility, and shall provide upon request copies of the same to PGE.

SECTION 18: SUCCESSORS AND ASSIGNS

This Agreement and all of the terms hereof shall be binding upon and inure to the benefit of the respective successors and assigns of the Parties. No assignment hereof by either Party shall become effective without the written consent of the other Party being first obtained and such consent shall not be unreasonably withheld. Notwithstanding the foregoing, either Party may assign this Agreement without the other Party's consent as part of (a) a sale of all or substantially all of the assigning Party's assets, or (b) a merger, consolidation or other reorganization of the assigning Party.

SECTION 19: ENTIRE AGREEMENT

19.1. This Agreement supersedes all prior agreements, proposals, representations, negotiations, discussions or letters, whether oral or in writing, regarding PGE's purchase of Net Output from the Facility. No modification of this Agreement shall be effective unless it is in writing and signed by both Parties.

19.2. By executing this Agreement, Seller releases PGE from any third party claims related to the Facility, known or unknown, which may have arisen prior to the Effective Date.

SECTION 20: NOTICES

20.1. All notices except as otherwise provided in this Agreement shall be in writing, shall be directed as follows and shall be considered delivered if delivered in person or when deposited in the U.S. Mail, postage prepaid by certified or registered mail and return receipt requested:

To Seller: **Skyward Solar, LLC c/o Chris Norqual**
3250 Ocean Park Blvd., Suite 355
Santa Monica, CA 90405
Email: utility@ccrenew.com

with a copy to: **Skyward Solar, LLC c/o Asset Management**

3250 Ocean Park Blvd., Suite 355
Santa Monica, CA 90405
Email: assetmanagement@ccrenew.com

To PGE: Contracts Manager
 QF Contracts, 3WTC0306
 PGE - 121 SW Salmon St.
 Portland, Oregon 97204

20.2 The Parties may change the person to whom such notices are addressed, or their addresses, by providing written notices thereof in accordance with this Section 20.

IN WITNESS WHEREOF, the Parties hereto have caused this Agreement to be executed in their respective names as of the Effective Date.

PGE

By: _____
Name: _____
Title: _____
Date: _____

Skyward Solar, LLC

(Name Seller)

By: 
Name: Matthew McGovern
Title: Authorized Person
Date: 5/31/2017

EXHIBIT A
DESCRIPTION OF SELLER'S FACILITY

Aerial Facility site boundary map

Skyward Solar
37121-37599 SE Kelso Rd, Sandy, OR 97055
POI: 45°25'5.79"N, 122°16'36.54"



Map adjoining QF sites owned by the same seller at this time , or within the past 12 months

PGE Projects Owned by CCR

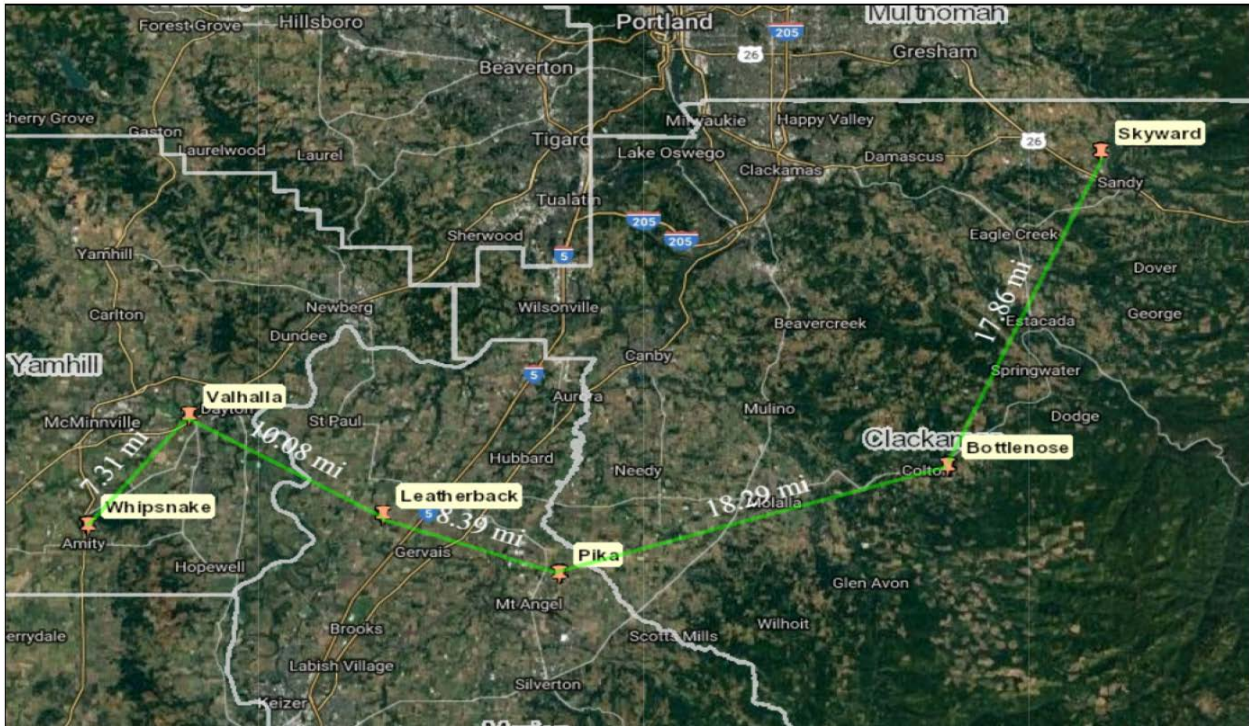

Draft - NOT FOR

Solar Facility Characteristics:

Note this information is considered representative design information which is to be updated at the time of project construction and is subject to design finalization

1. Generation

- a. PVSyst (or equivalent) simulation results detail, including but not limited to:
 - i. Annual MWh (AC) for the first calendar year of commercial operation
3638.546
 - ii. Annual degradation factor 0.05%
 - iii. Average 24-hr profile of generation MWh (AC) for each month during the first calendar year

Hour	Jan	Feb	Mar	Apr	May	Jun	Jul	Aug	Sep	Oct	Nov	Dec	Annual
0	0.0	0.0	0.0	0.0	0.0	0.0	0.0	0.0	0.0	0.0	0.0	0.0	0.0
1	0.0	0.0	0.0	0.0	0.0	0.0	0.0	0.0	0.0	0.0	0.0	0.0	0.0
2	0.0	0.0	0.0	0.0	0.0	0.0	0.0	0.0	0.0	0.0	0.0	0.0	0.0
3	0.0	0.0	0.0	0.0	0.0	0.0	0.0	0.0	0.0	0.0	0.0	0.0	0.0
4	0.0	0.0	0.0	0.0	0.2	0.3	0.0	0.0	0.0	0.0	0.0	0.0	0.5
5	0.0	0.0	0.0	0.4	2.4	2.9	2.1	0.8	0.0	0.0	0.0	0.0	8.6
6	0.0	0.0	1.0	5.4	10.0	11.2	10.2	6.6	3.6	0.8	0.0	0.0	48.9
7	0.0	1.8	8.8	17.0	21.4	22.3	23.7	19.6	15.8	7.7	2.5	0.0	140.5
8	5.1	10.5	20.2	29.2	32.9	32.7	36.9	33.2	29.5	18.4	10.6	4.1	263.4
9	13.7	20.4	30.2	37.1	41.0	41.0	48.7	46.1	41.2	26.6	19.9	9.8	375.6
10	20.3	25.9	34.6	40.2	43.5	42.6	53.9	54.2	49.1	33.0	24.1	16.9	438.3
11	22.5	28.4	35.5	41.9	44.2	42.6	53.9	56.7	53.4	35.8	25.4	21.8	462.1
12	23.6	27.5	35.9	42.7	45.8	44.9	53.9	58.0	54.8	37.3	23.9	21.6	469.9
13	22.0	25.0	31.8	41.2	46.5	46.0	55.6	57.0	49.5	35.5	20.5	17.9	448.5
14	17.8	21.1	27.3	36.2	42.6	43.7	53.6	52.0	40.5	28.4	15.7	12.3	391.1
15	8.8	15.4	22.3	30.0	35.7	37.4	43.7	42.0	31.3	18.7	7.1	6.4	298.9
16	2.1	7.1	13.9	20.9	25.9	28.6	33.7	28.5	18.7	6.9	1.3	0.2	187.8
17	0.0	0.9	4.7	9.1	13.1	16.4	19.5	12.9	5.4	0.6	0.0	0.0	82.5
18	0.0	0.0	0.1	1.4	3.7	5.8	5.7	2.4	0.2	0.0	0.0	0.0	19.3
19	0.0	0.0	0.0	0.0	0.4	1.2	1.0	0.1	0.0	0.0	0.0	0.0	2.7
20	0.0	0.0	0.0	0.0	0.0	0.0	0.0	0.0	0.0	0.0	0.0	0.0	0.0
21	0.0	0.0	0.0	0.0	0.0	0.0	0.0	0.0	0.0	0.0	0.0	0.0	0.0
22	0.0	0.0	0.0	0.0	0.0	0.0	0.0	0.0	0.0	0.0	0.0	0.0	0.0
23	0.0	0.0	0.0	0.0	0.0	0.0	0.0	0.0	0.0	0.0	0.0	0.0	0.0

iv. Maximum 24-hr profile of generation MWh (AC) for each month during the first calendar year

Hour	Jan	Feb	Mar	Apr	May	Jun	Jul	Aug	Sep	Oct	Nov	Dec	Annual
0	0.0	0.0	0.0	0.0	0.0	0.0	0.0	0.0	0.0	0.0	0.0	0.0	0.0
1	0.0	0.0	0.0	0.0	0.0	0.0	0.0	0.0	0.0	0.0	0.0	0.0	0.0
2	0.0	0.0	0.0	0.0	0.0	0.0	0.0	0.0	0.0	0.0	0.0	0.0	0.0
3	0.0	0.0	0.0	0.0	0.0	0.0	0.0	0.0	0.0	0.0	0.0	0.0	0.0
4	0.0	0.0	0.0	0.0	0.1	0.1	0.0	0.0	0.0	0.0	0.0	0.0	0.2
5	0.0	0.0	0.0	0.5	2.6	3.3	2.7	0.9	0.0	0.0	0.0	0.0	10.1
6	0.0	0.0	1.2	7.4	14.3	14.5	15.0	9.8	4.7	0.7	0.0	0.0	67.5
7	0.0	2.7	12.5	24.1	31.1	29.2	35.1	30.0	22.5	10.7	2.8	0.0	200.7
8	5.5	13.5	29.5	40.8	46.5	44.3	54.4	52.2	41.5	27.7	12.6	5.6	374.1
9	20.1	25.3	42.3	53.2	62.3	58.7	71.3	70.4	56.8	41.8	24.9	16.8	543.7
10	29.0	34.0	48.2	57.5	70.1	66.0	76.7	80.0	67.1	50.6	32.2	24.3	635.7
11	32.3	39.7	54.6	58.4	69.0	70.6	77.9	81.2	69.0	58.3	31.5	28.6	671.0
12	29.2	42.8	56.7	59.9	68.6	69.2	79.7	80.1	71.1	59.9	30.1	28.7	675.8
13	26.3	39.6	50.9	64.3	65.7	66.8	77.8	79.9	70.7	51.7	31.1	24.0	648.8
14	24.0	30.8	44.3	63.0	60.6	66.1	76.6	73.4	63.0	39.4	27.5	18.2	587.0
15	13.4	20.5	35.5	49.3	52.8	58.2	66.7	58.0	49.4	26.1	14.1	8.0	452.0
16	3.4	9.5	22.6	32.1	36.6	43.6	49.3	39.3	29.8	10.5	2.2	0.5	279.3
17	0.0	1.3	7.6	14.4	18.9	24.3	27.6	19.1	8.5	1.0	0.0	0.0	122.8
18	0.0	0.0	0.2	1.8	5.4	7.6	7.8	3.5	0.3	0.0	0.0	0.0	26.5
19	0.0	0.0	0.0	0.0	0.5	1.4	1.2	0.1	0.0	0.0	0.0	0.0	3.2
20	0.0	0.0	0.0	0.0	0.0	0.0	0.0	0.0	0.0	0.0	0.0	0.0	0.0
21	0.0	0.0	0.0	0.0	0.0	0.0	0.0	0.0	0.0	0.0	0.0	0.0	0.0
22	0.0	0.0	0.0	0.0	0.0	0.0	0.0	0.0	0.0	0.0	0.0	0.0	0.0
23	0.0	0.0	0.0	0.0	0.0	0.0	0.0	0.0	0.0	0.0	0.0	0.0	0.0

v. Maximum annual output (monthly MWh detail)

Month	January	February	March	April	May	June	July	August	September	October	November	December
MWh	183.2	259.7	406.2	526.5	604.9	623.7	719.7	678.0	554.4	378.3	209.0	154.7

vi. Expected Solar Capacity Factor

AC Capacity Factor	18%
DC Capacity Factor	13%

vii. Maximum annual output (monthly MWh detail)

Loss diagram over the whole year

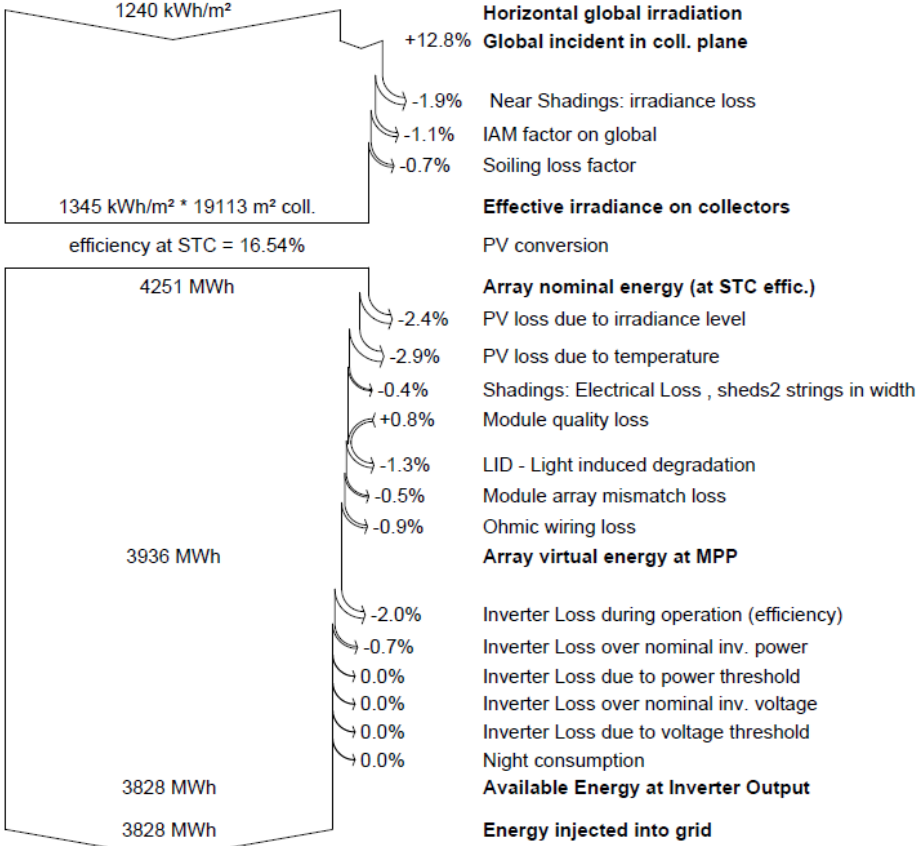

Draft - NC

2. Description of Modules:
 - a. Module type: 330 W Hanwha Q Cell Modules (or equivalent)
 - b. # of modules: 8,484
 - c. Max power voltage: 37.02
 - d. Max power current: 8.91A
 - e. Max system voltage: 1500V
 - f. Total DC system size: 2,799,720 W DC

3. Description of Racking
 - a. Racking
 - i. Type: (fixed tilt, single-axis tracking, or dual-axis tracking, etc.): Fixed tilt
 - ii. Tilt angle (if fixed-tilt): 20°
 - iii. Azimuth (default = south-facing): 180°

4. Description of Inverters:
 - a. Number of Inverters: 50
 - b. Model: Huawei SUN2000-45KTL-US
 - c. Maximum Power (kW): 45kW
 - d. Operating Voltage (VAC): 600V
 - e. Max. Output Current (A): 43.3
 - f. Rated DC Voltage: 1500V
 - g. Rated DC current: 30A x 4 inputs
 - h. Maximum Output (kW): 45kW
 - g. Facility AC Capacity Rating: 2.25 MW
 - h. Inverter loading ratio: 1.25
 - i. Facility AC rating: 2.25 MW

5. Description of transformers
 - a. # of transformers: 1
 - b. Model: Cooper Power Systems
 - c. High Voltage Rating: 12kV
 - d. Low Voltage Rating: 600V
 - e. MVA rating: 2.5
 - f. High voltage connection: Wye-ground
 - g. Low voltage connection: Wye-ground

6. Description of metering, communications, and monitoring:

Utility and owner metering in utility-compliant switchgear. Remote monitoring and communications via cellular networks.

7. Description of station service requirements:

Up to 20 kVA of station load for miscellaneous communications and control equipment.

8. Description and timeline of interconnection and transmission plan:
Interconnection to 12kV utility distribution network. Interconnection timeline dependent of utility study and upgrade schedule.
9. Transaction Service Request Number, Interconnection Queue number, and System impact/interconnection study documentation:
Interconnection application submitted; Feasibility Study is in process with deposit paid.

Draft - NOT FOR EXECUTION



Q.ANTUM SOLAR MODULE

The Q.ANTUM solar module Q.PLUS L-G4.2 with power classes up to 340 Wp is the strongest module of its type on the market globally. Powered by 72 Q CELLS solar cells Q.PLUS L-G4.2 was specially designed for large solar power plants to reduce BOS costs. Only Q CELLS offers German engineering quality with our unique triple Yield Security.



LOW ELECTRICITY GENERATION COSTS

Higher yield per surface area and lower BOS costs thanks to higher power classes and an efficiency rate of up to 17.4 %.



INNOVATIVE ALL-WEATHER TECHNOLOGY

Optimal yields, whatever the weather with excellent low-light and temperature behavior.



ENDURING HIGH PERFORMANCE

Long-term yield security with Anti-PID Technology¹, Hot-Spot-Protect and Traceable Quality Tra.Q™.



LIGHT-WEIGHT QUALITY FRAME

High-tech aluminum alloy frame, certified for high snow (5400 Pa) and wind loads (2400 Pa).



A RELIABLE INVESTMENT

Inclusive 12-year product warranty and 25-year linear performance guarantee².



THE IDEAL SOLUTION FOR:



Ground-mounted solar power plants

Engineered in **Germany**

¹ APT test conditions: Cells at -1000V against grounded, with conductive metal foil covered module surface, 25°C, 168h

² See data sheet on rear for further information.



MECHANICAL SPECIFICATION

Format	78.5 in × 39.4 in × 1.38 in (including frame) (1994 mm × 1000 mm × 35 mm)
Weight	52.9 lb (24 kg)
Front Cover	0.13 in (3.2 mm) thermally pre-stressed glass with anti-reflection technology
Back Cover	Composite film
Frame	Anodised aluminium
Cell	6 × 12 Q-ANTUM solar cells
Junction box	3.35-4.13 in × 2.36-3.15 in × 0.59-0.67 in (85-105 mm × 60-80 mm × 15-17 mm), Protection class ≥ IP67, with bypass diodes
Cable	4 mm ² Solar cable; (+) ≥ 47.24 in (1200 mm), (-) ≥ 47.24 in (1200 mm)
Connector	Amphenol H4 UTX, IP68



ELECTRICAL CHARACTERISTICS

POWER CLASS		330	335	340	
MINIMUM PERFORMANCE AT STANDARD TEST CONDITIONS, STC¹ (POWER TOLERANCE +5W/-0W)					
Minimum	Power at MPP ²	P_{MPP} [W]	330	335	340
	Short Circuit Current ³	I_{SC} [A]	9.49	9.54	9.59
	Open Circuit Voltage ⁴	V_{OC} [V]	46.55	46.81	47.07
	Current at MPP ²	I_{MPP} [A]	8.91	8.97	9.03
	Voltage at MPP ²	V_{MPP} [V]	37.02	37.33	37.63
	Efficiency ⁵	η [%]	≥ 16.5	≥ 16.8	≥ 17.1
	MINIMUM PERFORMANCE AT NORMAL OPERATING CONDITIONS, NOC³				
Mininum	Power at MPP ²	P_{MPP} [W]	244.7	248.4	252.1
	Short Circuit Current ³	I_{SC} [A]	7.65	7.69	7.73
	Open Circuit Voltage ⁴	V_{OC} [V]	43.44	43.68	43.92
	Current at MPP ²	I_{MPP} [A]	6.99	7.04	7.09
	Voltage at MPP ²	V_{MPP} [V]	35.01	35.29	35.56

¹1000 W/m², 25°C, spectrum AM 1.5 G ²Measurement tolerances STC ±3%; NOC ±5% ³800 W/m², NOCT, spectrum AM 1.5 G ⁴typical values, actual values may differ

Q CELLS PERFORMANCE WARRANTY

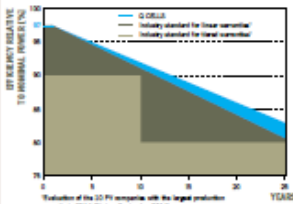

At least 97% of nominal power during first year. Thereafter max. 0.6% degradation per year.
At least 92% of nominal power after 10 years.
At least 83% of nominal power after 25 years.
All data within measurement tolerances. Full warranties in accordance with the warranty terms of the Q CELLS sales organisation of your respective country.

PERFORMANCE AT LOW IRRADIANCE

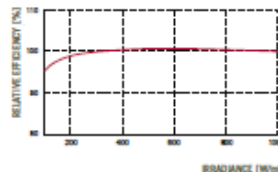

Typical module performance under low irradiance conditions in comparison to STC conditions (25°C, 1000W/m²).

TEMPERATURE COEFFICIENTS

Temperature Coefficient of I_{SC}	α	[%/K]	+0.04	Temperature Coefficient of V_{OC}	β	[%/K]	-0.29
Temperature Coefficient of P_{MPP}	γ	[%/K]	-0.40	Normal Operating Cell Temperature	NOCT	[°F]	113 ± 5.4 (45 ± 3°C)

PROPERTIES FOR SYSTEM DESIGN

Maximum System Voltage V_{ms}	[V]	1500 (IEC) / 1500 (UL)	Safety Class	II
Maximum Series Fuse Rating	[A DC]	15	Fire Rating	C / TYPE 1
Max Load (UL) ²	[lbs/# ²]	75 (3600 Pa)	Permitted module temperature on continuous duty	-40°F up to +185°F (-40°C up to +85°C)
Load Rating (UL) ²	[lbs/# ²]	33 (1600 Pa)	² see installation manual	

QUALIFICATIONS AND CERTIFICATES

IEC 61215 (Ed. 2); IEC 61730 (Ed. 1), Application class A
This data sheet complies with DIN EN 50380.



PACKAGING INFORMATION

Number of Modules per Pallet	29
Number of Pallets per 40' Container	22
Pallet Dimensions (L × W × H)	81.3 × 45.3 × 46.9 in (2065 × 1150 × 1190mm)
Pallet Weight	1671 lbs (758 kg)

NOTE: Installation instructions must be followed. See the installation and operating manual or contact our technical service department for further information on approved installation and use of this product.

Harwa Q CELLS USA Corp.
300 Spectrum Center Drive, Suite 1250, Irvine, CA 92618, USA | TEL +1 949 748 59 96 | WEB www.q-cells.com

Q CELLS

Engineered in Germany

String Inverter (SUN2000-45KTL-US-HV)



Smart

- 4 MPPTs for versatile adaptations to different layouts
- 8 strings intelligent monitoring and fast trouble-shooting
- Power Line Communication (PLC) supported
- Smart String I-V Diagnosis supported

Safe

- DC AFCI compliant to UL 1699B
- DC disconnect integrated, safe and convenient for maintenance
- Category surge arresters for both DC and AC
- Ground fault protection
- Residual Current Detection (RCD) protection

Efficient

- Max. efficiency 98.8%, CEC. efficiency 98.5%

Reliable

- Natural cooling technology
- Protection rating of NEMA 4X

Efficiency Curve

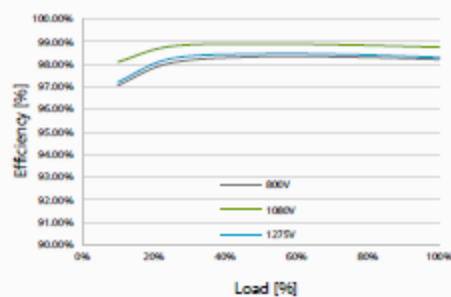

Circuit Diagram

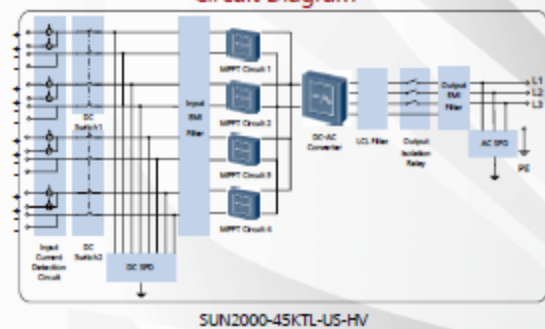

Always Available for Highest Yields



www.huawei.com/solar

String Inverter (SUN2000-45KTL-US-HV)



Technical Specifications	SUN2000-45KTL-US-HV-D0
	Efficiency
Max. Efficiency	98.8%
California Energy Commission Efficiency	98.5%
	Input
Max. Input Voltage	1,500 V
Max. Current per MPPT	22 A
Max. Short Circuit Current per MPPT	30 A
Min. Operating Voltage / Start Voltage	600V / 650V
Full Power MPPT Voltage Range	880 V – 1,275 V
MPPT Operating Voltage Range	600 V – 1,450 V
Rated Input Voltage	1,080 V
Max. Number of Inputs	8
Number of MPPT Trackers	4
	Output
Rated AC Active Power	45,000 W
Max. AC Apparent Power	45,000 VA
Rated Output Voltage	600 Vac, 3W+PE
Rated AC Grid Frequency	50 Hz / 60 Hz
Max. Output Current	43.3 A
Adjustable Power Factor	0.8 LG ... 0.8 LD
Max. Total Harmonic Distortion	< 3%
	Protection
Input-side Disconnection Device	Yes
Anti-islanding Protection	Yes
AC Overcurrent Protection	Yes
DC Reverse-Polarity Protection	Yes
PV-array String Fault Monitoring	Yes
DC Surge Arrester	Category C
AC Surge Arrester	Category C
Insulation Monitoring	Yes
Residual Current Detection	Yes
	Communication
Display	LED Indicators
RS485	Yes
USB / Bluetooth + APP	Yes
Power Line Communication (PLC)	Yes
	General
Dimensions (W x H x D)	36.6 x 23.6 x 10.6 inches (930 x 600 x 270 mm)
Weight	143 lb. (65 kg)
Operation Temperature Range	-13°F – +140°F (-25 °C – +60 °C)
Cooling	Natural Convection
Max. Operating Altitude Without Derating	15,123 ft. (4,600 m)
Relative Humidity	0 – 100%
DC Connector	Amphenol Helios H4
AC Connector	Waterproof PG Terminal + OT Connector
Protection Rating	NEMA 4X
Internal Consumption at Night	< 3 W
Topology	Transformerless
	Standards Compliance
Safety EMC	UL 1741, UL 1699B, UL 1998, CSA C22.2 #107.1-01, FCC Part 15
Grid Code	IEEE 1547, IEEE 1547.1

Always Available for Highest Yields



www.huawei.com/solar

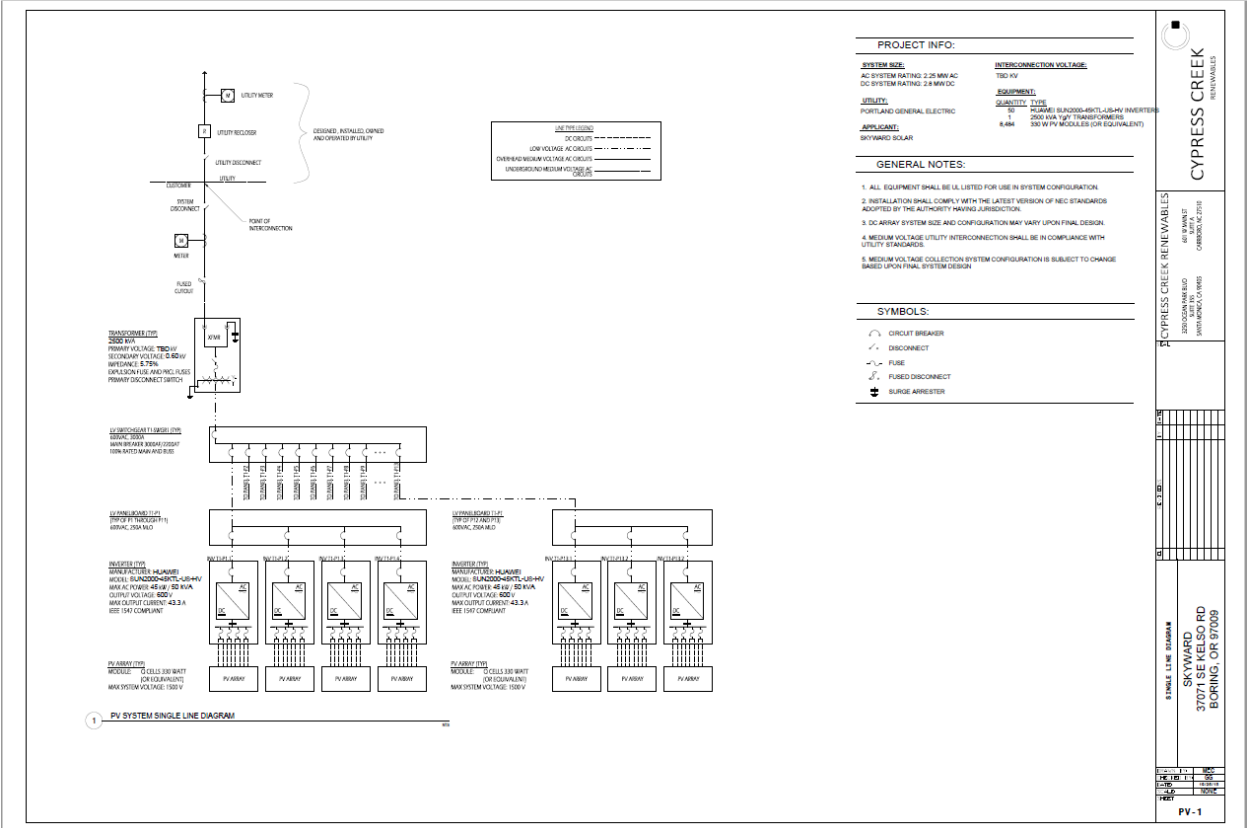

PROJECT INFO:

SYSTEM SIZE: AC SYSTEM RATING: 2.25 MW AC DC SYSTEM RATING: 2.8 MW DC	INTERCONNECTION VOLTAGE: 720 VV
UTILITIES: PORTLAND GENERAL ELECTRIC	EQUIPMENT: INVERTER: SUN2000-48TL-015HV (PREFERRED) 2500 VVA 1"PT TRANSFORMER 330 W PV MODULES (OR EQUIVALENT)
APPLICANT: SOLARWIS SOLAR	

- GENERAL NOTES:**
1. ALL EQUIPMENT SHALL BE LISTED FOR USE IN SYSTEM CONFIGURATION.
 2. INSTALLATION SHALL COMPLY WITH THE LATEST VERSION OF NEC STANDARDS ADOPTED BY THE AUTHORITY HAVING JURISDICTION.
 3. DC ARRAY SYSTEM SIZE AND CONFIGURATION MAY VARY UPON FINAL DESIGN.
 4. MEDIUM VOLTAGE UTILITY INTERCONNECTION SHALL BE IN COMPLIANCE WITH UTILITY STANDARDS.
 5. MEDIUM VOLTAGE COLLECTION SYSTEM CONFIGURATION IS SUBJECT TO CHANGE BASED UPON FINAL SYSTEM DESIGN.

SYMBOLS:

○	CIRCUIT BREAKER
⋈	DISCONNECT
—	FUSE
⋈	FUSED DISCONNECT
⚡	SURGE ARRESTER

CYPRESS CREEK RENEWABLES

CYPRESS CREEK RENEWABLES
 4850 HWY 101
 PORTLAND, OR 97201

SKYWARD
 3707 N. W. HWY 101
 BORING, OR 97009

PV-1

Draft - NOT FOR CONSTRUCTION

EXHIBIT B
REQUIRED FACILITY DOCUMENTS

Sellers Generation Interconnection Agreement: Expected 10/1/17

All required transmission Agreements: NA

All required environmental permits: NA

All required agreement to record Renewable Energy Certificates: Expected 10/1/17

Required site control documents: Executed lease agreement in place with XXXX

FERC Self-Certification and acceptance: QF17-864-000

Any Conditional Use Permits: Expected 8/1/17

Any Access Permit: Expected 7/1/18

Construction Permits: Expected 7/1/18

Water quality permits: NA

Draft - NOT FOR EXECUTION

EXHIBIT C START-UP TESTING

Required start-up test are those checks and tests necessary to determine that all features and equipment, systems, and subsystems have been properly designed, manufactured, installed and adjusted, function properly, and are capable of operating simultaneously in such condition that the Facility is capable of continuous delivery into BPA/EIM/PGE's electrical system for delivery to PGE, which may include but are not limited to (as applicable) the following:

1. Safety plan during startup and commissioning (including the expected number of individuals covered)
2. Review of all QA/QC testing
3. Confirm testing and energizing inverters in conformance with manufacturer's recommended procedures; note operating voltages; and confirm inverter is performing as expected
4. Energizing transformers
5. Under full sun conditions, and after at least 15 minutes of operation, taking and recording PV Plant operating data—such as but not limited to MWDC, MWAC, VDC, VAC, IDC, IAC, Solar Radiation, etc.
6. Testing the system control and monitoring system to verify that it is performing correctly
7. Testing the Plant metering and protective relaying to verify they meet utility requirements
8. Documentation of successful startup and commissioning procedure
9. Written notification submitted by Contractor to Owner that the completion of Acceptance Testing and Commissioning has occurred
10. Testing to meet the requirements of Section 1.5.3.

**SCHEDULE 201
QUALIFYING FACILITY 10 MW or LESS
AVOIDED COST POWER PURCHASE INFORMATION**

PURPOSE

To provide information about Standard Avoided Costs and Renewable Avoided Costs, Standard Power Purchase Agreements (PPA) and Negotiated PPAs, power purchase prices and price options for power delivered by a Qualifying Facility (QF) to the Company with nameplate capacity of 10,000 kW (10MW) or less.

AVAILABLE

To owners of QFs making sales of electricity to the Company in the State of Oregon (Seller).

APPLICABLE

For power purchased from small power production or cogeneration facilities that are QFs as defined in 18 Code of Federal Regulations (CFR) Section 292, that meet the eligibility requirements described herein and where the energy is delivered to the Company's system and made available for Company purchase pursuant to a Standard PPA.

ESTABLISHING CREDITWORTHINESS

The Seller must establish creditworthiness prior to service under this schedule. For a Standard PPA, a Seller may establish creditworthiness with a written acknowledgment that it is current on all existing debt obligations and that it was not a debtor in a bankruptcy proceeding within the preceding 24 months. If the Seller is not able to establish creditworthiness, the Seller must provide security deemed sufficient by the Company as set forth in the Standard PPA.

POWER PURCHASE INFORMATION

A Seller may call the Power Production Coordinator at (503) 464-8000 to obtain more information about being a Seller or how to apply for service under this schedule.

PPA

In accordance with terms set forth in this schedule and the Commission's Rules as applicable, the Company will purchase any Energy in excess of station service (power necessary to produce generation) and amounts attributable to conversion losses, which are made available from the Seller.

A Seller must execute a PPA with the Company prior to delivery of power to the Company. The agreement will have a term of up to 20 years as selected by the QF.

A QF with a nameplate capacity rating of 10 MW or less as defined herein may elect the option of a Standard PPA.

SCHEDULE 201 (Continued)

PPA (Continued)

Any Seller may elect to negotiate a PPA with the Company. Such negotiation will comply with the requirements of the Federal Energy Regulatory Commission (FERC), and the Commission including the guidelines in Order No. 07-360, and Schedule 202. Negotiations for power purchase pricing will be based on either the filed Standard Avoided Costs or Renewable Avoided Costs in effect at that time.

STANDARD PPA (Nameplate capacity of 10 MW or less)

A Seller choosing a Standard PPA will complete all informational and price option selection requirements in the applicable Standard PPA and submit the executed Agreement to the Company prior to service under this schedule. The Standard PPA is available at www.portlandgeneral.com. The available Standard PPAs are:

- Standard In-System Non-Variable Power Purchase Agreement
- Standard Off-System Non-Variable Power Purchase Agreement
- Standard In-System Variable Power Purchase Agreement
- Standard Off-System Variable Power Purchase Agreement
- Standard Renewable In-System Non-Variable Power Purchase Agreement
- Standard Renewable Off-System Non-Variable Power Purchase Agreement
- Standard Renewable In-System Variable Power Purchase Agreement
- Standard Renewable Off-System Variable Power Purchase Agreement

The Standard PPAs applicable to variable resources are available only to QFs utilizing wind, solar or run of river hydro as the primary motive force.

GUIDELINES FOR 10 MW OR LESS FACILITIES ELECTING STANDARD PPA

To execute the Standard PPA the Seller must complete all of the general project information requested in the applicable Standard PPA.

When all information required in the Standard PPA has been received in writing from the Seller, the Company will respond within 15 business days with a draft Standard PPA.

The Seller may request in writing that the Company prepare a final draft Standard PPA. The Company will respond to this request within 15 business days. In connection with such request, the QF must provide the Company with any additional or clarified project information that the Company reasonably determines to be necessary for the preparation of a final draft Standard PPA.

When both parties are in full agreement as to all terms and conditions of the draft Standard PPA, the Company will prepare and forward to the Seller a final executable version of the agreement within 15 business days. Following the Company's execution, an executed copy will be returned to the Seller.

Prices and other terms and conditions in the PPA will not be final and binding until the Standard PPA has been executed by both parties.

SCHEDULE 201 (Continued)**OFF-SYSTEM PPA**

A Seller with a facility that interconnects with an electric system other than the Company's electric system may enter into a PPA with the Company after following the applicable Standard or Negotiated PPA guidelines and making the arrangements necessary for transmission of power to the Company's system.

BASIS FOR POWER PURCHASE PRICE**AVOIDED COST SUMMARY**

The power purchase prices are based on either the Company's Standard Avoided Costs or Renewable Avoided Costs in effect at the time the agreement is executed. Avoided Costs are defined in 18 CFR 292.101(6) as "the incremental costs to an electric utility of electric energy or capacity or both which, but for the purchase from the qualifying facility or qualifying facilities, such utility would generate itself or purchase from another source."

Monthly On-Peak prices are included in both the Standard Avoided Costs as listed in Tables 1a, 2a, and 3a and Renewable Avoided Costs as listed in Tables 4a, 5a, and 6a. Monthly Off-Peak prices are included in both the Standard Avoided Costs as listed in Tables 1b, 2b, and 3b and Renewable Avoided Costs as listed in Tables 4b, 5b, and 6b.

ON-PEAK PERIOD

The On-Peak period is 6:00 a.m. until 10:00 p.m., Monday through Saturday.

OFF-PEAK PERIOD

The Off-Peak period is 10:00 p.m. until 6:00 a.m., Monday through Saturday, and all day on Sunday.

Standard Avoided Costs are based on forward market price estimates through the Resource Sufficiency Period, the period of time during which the Company's Standard Avoided Costs are associated with incremental purchases of Energy and capacity from the market. For the Resource Deficiency Period, the Standard Avoided Costs reflect the fully allocated costs of a natural gas fueled combined cycle combustion turbine (CCCT) including fuel and capital costs. The CCCT Avoided Costs are based on the variable cost of Energy plus capitalized Energy costs at a 93% capacity factor based on a natural gas price forecast, with prices modified for shrinkage and transportation costs.

Renewable Avoided Costs are based on forward market price estimates through the Renewable Resource Sufficiency Period, the period of time during which the Company's Renewable Avoided Costs are associated with incremental purchases of energy and capacity from the market. For the Renewable Resource Deficiency Period, the Renewable Avoided Costs reflect the fully allocated costs of a wind plant including capital costs.

SCHEDULE 201 (Continued)**PRICING FOR STANDARD PPA**

Pricing represents the purchase price per MWh the Company will pay for electricity delivered to a Point of Delivery (POD) within the Company's service territory pursuant to a Standard PPA up to the nameplate rating of the QF in any hour. Any Energy delivered in excess of the nameplate rating will be purchased at the applicable Off-Peak Prices for the selected pricing option.

The Standard PPA pricing will be based on either the Standard or Renewable Avoided Costs in effect at the time the agreement is executed.

The Company will pay the Seller either the Off-Peak Standard Avoided Cost pursuant to Tables 1b, 2b, or 3b or the Off-Peak Renewable Avoided Costs pursuant to Tables 4b, 5b, or 6b for: (a) all Net Output delivered prior to the Commercial Operation Date; (b) all Net Output deliveries greater than Maximum Net Output in any PPA year; (c) any generation subject to and as adjusted by the provisions of Section 4.3 of the Standard PPA; (d) Net Output delivered in the Off-Peak Period; and (e) deliveries above the nameplate capacity in any hour. The Company will pay the Seller either the On-Peak Standard Avoided Cost pursuant to Tables 1a, 2a, or 3a or the On-Peak Renewable Avoided Costs pursuant to Tables 4a, 5a, or 6a for all other Net Output. (See the PPA for defined terms.)

1) Standard Fixed Price Option

The Standard Fixed Price Option is based on Standard Avoided Costs including forecasted natural gas prices. It is available to all QFs.

This option is available for a maximum term of 15 years. Prices will be as established at the time the Standard PPA is executed and will be equal to the Standard Avoided Costs in Tables 1a and 1b, 2a and 2b, or 3a and 3c, depending on the type of QF, effective at execution. QFs using any resource type other than wind and solar are assumed to be Base Load QFs.

Prices paid to the Seller under the Standard Fixed Price Option include adjustments for the capacity contribution of the QF resource type relative to that of the avoided proxy resource. Both the Base Load QF resources (Tables 1a and 1b) and the avoided proxy resource, the basis used to determine Standard Avoided Costs for the Standard Fixed Price Option, are assumed to have a capacity contribution to peak of 100%. The capacity contribution for Wind QF resources (Tables 2a and 2b) is assumed to be 5%. The capacity contribution for Solar QF resources (Tables 3a and 3b) is assumed to be 5%.

Prices paid to the Seller under the Standard Fixed Price Option for Wind QFs (Tables 2a and 2b) include a reduction for the wind integration costs in Table 7. However, if the Wind QF is outside of PGE's Balancing Authority Area as contemplated in the Commission's Order No. 14-058, the Seller is paid the wind integration charges in Table 7, in addition to the prices listed in Tables 2a and 2b, for a net-zero effect.

SCHEDULE 201 (Continued)

PRICING OPTIONS FOR STANDARD PPA (Continued)
Standard Fixed Price Option (Continued)

Sellers with PPAs exceeding 15 years will receive pricing equal to the Mid-C Index Price for all years up to five in excess of the initial 15.

SCHEDULE 201 (Continued)

PRICING OPTIONS FOR STANDARD PPA (Continued)
 Standard Fixed Price Option (Continued)

TABLE 1a												
Avoided Costs												
Standard Fixed Price Option for Base Load QF												
On-Peak Forecast (\$/MWH)												
Year	Jan	Feb	Mar	Apr	May	Jun	Jul	Aug	Sep	Oct	Nov	Dec
2016	28.21	22.46	15.61	14.71	12.46	16.96	23.96	26.96	24.96	23.71	26.71	31.46
2017	29.96	28.21	24.71	20.96	19.46	20.46	27.96	30.96	29.46	27.71	28.71	33.71
2018	31.71	31.11	28.11	22.13	21.28	21.28	29.93	33.37	30.63	28.61	31.86	35.71
2019	33.94	31.95	27.97	23.70	22.00	23.13	31.67	35.08	33.37	31.38	32.52	38.21
2020	35.74	33.64	29.45	24.95	23.15	24.35	33.34	36.94	35.14	33.04	34.24	40.24
2021	67.43	67.34	65.41	64.69	64.41	64.50	64.61	64.73	64.84	65.48	68.60	68.72
2022	69.01	68.84	68.08	67.13	66.81	66.91	67.04	67.17	67.29	67.83	71.38	71.70
2023	71.95	71.76	70.39	69.19	69.07	69.18	69.31	69.45	69.58	70.12	73.56	73.70
2024	74.17	73.85	72.67	71.29	71.10	71.21	71.35	71.50	71.63	72.20	76.49	76.64
2025	77.19	77.30	75.84	74.88	75.02	75.14	75.30	75.47	75.62	75.80	82.57	82.89
2026	85.18	85.30	82.77	81.28	81.22	81.36	81.56	81.74	81.90	82.36	89.02	88.72
2027	86.85	86.76	85.14	83.12	82.89	83.03	83.00	83.32	83.46	83.97	91.39	91.15
2028	89.32	89.31	87.96	85.46	85.30	85.46	85.31	85.64	85.95	86.65	94.66	93.55
2029	94.06	93.99	91.23	88.74	87.97	88.15	87.71	88.06	88.61	89.34	98.37	98.11
2030	97.60	97.54	94.87	92.62	92.40	92.57	92.61	93.00	93.12	93.68	102.42	102.70
2031	99.56	99.50	96.78	94.48	94.26	94.43	94.47	94.87	94.99	95.56	104.47	104.76
2032	103.85	103.80	100.57	98.18	97.96	98.15	98.23	98.65	98.76	99.36	108.86	109.41
2033	106.56	106.51	103.17	100.72	100.50	100.69	100.78	101.21	101.32	101.93	111.67	112.26
2034	109.12	109.07	105.60	103.10	102.88	103.08	103.17	103.61	103.72	104.35	114.33	114.96
2035	111.55	111.51	107.91	105.35	105.12	105.33	105.43	105.89	105.99	106.63	116.87	117.54
2036	113.85	113.80	110.14	107.53	107.30	107.51	107.60	108.07	108.18	108.83	119.27	119.95
2037	116.50	116.45	112.72	110.06	109.82	110.04	110.14	110.61	110.73	111.39	122.03	122.73
2038	119.08	119.03	115.22	112.51	112.27	112.49	112.59	113.08	113.19	113.87	124.71	125.42
2039	121.47	121.42	117.54	114.77	114.53	114.75	114.85	115.35	115.47	116.15	127.21	127.93
2040	124.25	124.20	120.25	117.43	117.18	117.41	117.51	118.02	118.14	118.84	130.10	130.85
2041	126.72	126.67	122.64	119.76	119.51	119.74	119.85	120.36	120.49	121.20	132.68	133.44

SCHEDULE 201 (Continued)

PRICING OPTIONS FOR STANDARD PPA (Continued)
Standard Fixed Price Option (Continued)

TABLE 1b												
Avoided Costs												
Standard Fixed Price Option for Base Load QF												
Off-Peak Forecast (\$/MWH)												
Year	Jan	Feb	Mar	Apr	May	Jun	Jul	Aug	Sep	Oct	Nov	Dec
2016	25.61	20.71	13.96	11.41	6.31	10.11	15.71	20.96	20.96	21.21	23.46	26.71
2017	25.71	24.21	22.21	15.71	13.71	12.71	19.71	25.21	25.46	24.71	25.71	27.96
2018	26.17	28.12	25.56	19.46	14.68	12.54	19.71	27.04	26.93	25.35	28.20	30.62
2019	29.84	28.09	25.75	18.15	15.81	14.64	22.83	29.26	29.55	28.67	29.84	32.47
2020	31.75	29.88	27.38	19.28	16.79	15.54	24.27	31.12	31.43	30.50	31.75	34.55
2021	28.88	28.79	26.86	26.15	25.87	25.95	26.07	26.19	26.30	26.94	30.06	30.18
2022	29.73	29.56	28.79	27.85	27.53	27.63	27.75	27.88	28.00	28.54	32.09	32.42
2023	31.78	31.59	30.21	29.01	28.90	29.00	29.14	29.27	29.40	29.95	33.38	33.52
2024	33.48	33.16	31.98	30.60	30.41	30.52	30.66	30.81	30.95	31.51	35.80	35.96
2025	35.58	35.69	34.24	33.27	33.42	33.53	33.70	33.86	34.01	34.19	40.97	41.28
2026	42.77	42.89	40.36	38.87	38.81	38.95	39.15	39.34	39.50	39.95	46.62	46.31
2027	43.63	43.54	41.91	39.89	39.66	39.80	39.77	40.09	40.24	40.74	48.16	47.92
2028	45.26	45.25	43.90	41.40	41.23	41.40	41.25	41.58	41.89	42.59	50.60	49.48
2029	49.15	49.08	46.32	43.83	43.06	43.24	42.80	43.15	43.70	44.43	53.46	53.20
2030	51.82	51.76	49.09	46.84	46.62	46.79	46.83	47.22	47.34	47.90	56.64	56.92
2031	52.90	52.84	50.11	47.82	47.59	47.77	47.81	48.21	48.33	48.90	57.81	58.10
2032	56.59	56.54	53.31	50.92	50.70	50.89	50.97	51.39	51.50	52.10	61.60	62.15
2033	58.08	58.03	54.69	52.24	52.02	52.21	52.30	52.73	52.84	53.45	63.19	63.78
2034	59.54	59.50	56.03	53.52	53.30	53.50	53.59	54.04	54.15	54.77	64.76	65.39
2035	61.18	61.14	57.54	54.98	54.75	54.96	55.06	55.52	55.62	56.26	66.50	67.17
2036	62.67	62.62	58.96	56.35	56.12	56.33	56.43	56.89	57.00	57.65	68.09	68.78
2037	64.17	64.12	60.39	57.73	57.49	57.71	57.80	58.28	58.39	59.06	69.69	70.39
2038	65.73	65.69	61.88	59.17	58.93	59.15	59.25	59.73	59.85	60.52	71.37	72.08
2039	67.09	67.04	63.16	60.40	60.15	60.38	60.48	60.98	61.09	61.78	72.83	73.56
2040	68.83	68.78	64.83	62.01	61.76	61.99	62.09	62.60	62.72	63.42	74.68	75.42
2041	70.23	70.17	66.14	63.27	63.02	63.25	63.36	63.87	63.99	64.71	76.19	76.95

SCHEDULE 201 (Continued)PRICING OPTIONS FOR STANDARD PPA (Continued)
Standard Fixed Price Option (Continued)

TABLE 2a												
Avoided Costs												
Standard Fixed Price Option for Wind QF												
On-Peak Forecast (\$/MWH)												
Year	Jan	Feb	Mar	Apr	May	Jun	Jul	Aug	Sep	Oct	Nov	Dec
2016	24.37	18.62	11.77	10.87	8.62	13.12	20.12	23.12	21.12	19.87	22.87	27.62
2017	26.05	24.30	20.80	17.05	15.55	16.55	24.05	27.05	25.55	23.80	24.80	29.80
2018	27.72	27.12	24.12	18.14	17.29	17.29	25.94	29.38	26.64	24.62	27.87	31.72
2019	29.87	27.88	23.90	19.63	17.93	19.06	27.60	31.01	29.30	27.31	28.45	34.14
2020	31.59	29.49	25.30	20.80	19.00	20.20	29.19	32.79	30.99	28.89	30.09	36.09
2021	30.68	30.59	28.66	27.94	27.66	27.75	27.87	27.99	28.10	28.74	31.86	31.98
2022	31.56	31.39	30.62	29.68	29.36	29.46	29.59	29.72	29.84	30.38	33.93	34.25
2023	33.67	33.48	32.11	30.91	30.79	30.90	31.03	31.17	31.30	31.84	35.28	35.42
2024	35.38	35.06	33.88	32.49	32.30	32.42	32.56	32.70	32.84	33.40	37.70	37.85
2025	37.53	37.64	36.18	35.22	35.36	35.48	35.64	35.81	35.96	36.14	42.91	43.23
2026	44.75	44.87	42.35	40.86	40.79	40.94	41.13	41.32	41.48	41.94	48.60	48.29
2027	45.65	45.56	43.93	41.91	41.68	41.82	41.79	42.12	42.26	42.76	50.18	49.94
2028	47.32	47.31	45.96	43.46	43.30	43.46	43.31	43.64	43.95	44.65	52.66	51.55
2029	51.25	51.18	48.43	45.94	45.16	45.34	44.90	45.25	45.80	46.53	55.57	55.30
2030	53.96	53.90	51.23	48.98	48.76	48.93	48.97	49.36	49.48	50.04	58.78	59.06
2031	55.08	55.02	52.29	50.00	49.77	49.95	49.99	50.38	50.51	51.08	59.99	60.28
2032	58.77	58.72	55.49	53.10	52.88	53.07	53.15	53.57	53.68	54.28	63.78	64.33
2033	60.35	60.30	56.96	54.51	54.29	54.49	54.57	55.00	55.11	55.72	65.46	66.05
2034	61.88	61.83	58.36	55.86	55.63	55.84	55.93	56.37	56.48	57.10	67.09	67.72
2035	63.54	63.49	59.90	57.34	57.11	57.32	57.42	57.87	57.98	58.62	68.86	69.53
2036	65.04	65.00	61.33	58.72	58.49	58.70	58.80	59.27	59.38	60.03	70.46	71.15
2037	66.61	66.57	62.83	60.17	59.93	60.15	60.25	60.73	60.84	61.50	72.14	72.84
2038	68.23	68.18	64.37	61.66	61.42	61.64	61.74	62.23	62.34	63.02	73.86	74.57
2039	69.64	69.59	65.71	62.94	62.70	62.92	63.03	63.52	63.64	64.33	75.38	76.11
2040	71.42	71.37	67.41	64.60	64.35	64.58	64.68	65.18	65.30	66.00	77.27	78.01
2041	72.87	72.82	68.79	65.92	65.66	65.90	66.00	66.52	66.64	67.35	78.84	79.59

SCHEDULE 201 (Continued)PRICING OPTIONS FOR STANDARD PPA (Continued)
Standard Fixed Price Option (Continued)

TABLE 2b												
Avoided Costs												
Standard Fixed Price Option for Wind QF												
Off-Peak Forecast (\$/MWH)												
Year	Jan	Feb	Mar	Apr	May	Jun	Jul	Aug	Sep	Oct	Nov	Dec
2016	21.77	16.87	10.12	7.57	2.47	6.27	11.87	17.12	17.12	17.37	19.62	22.87
2017	21.80	20.30	18.30	11.80	9.80	8.80	15.80	21.30	21.55	20.80	21.80	24.05
2018	22.18	24.13	21.57	15.47	10.69	8.55	15.72	23.05	22.94	21.36	24.21	26.63
2019	25.77	24.02	21.68	14.08	11.74	10.57	18.76	25.19	25.48	24.60	25.77	28.40
2020	27.60	25.73	23.23	15.13	12.64	11.39	20.12	26.97	27.28	26.35	27.60	30.40
2021	24.65	24.56	22.63	21.92	21.64	21.72	21.84	21.96	22.07	22.71	25.83	25.95
2022	25.42	25.25	24.48	23.54	23.22	23.32	23.44	23.57	23.69	24.23	27.78	28.11
2023	27.39	27.20	25.82	24.62	24.51	24.61	24.75	24.88	25.01	25.56	28.99	29.13
2024	29.01	28.69	27.51	26.13	25.94	26.05	26.19	26.34	26.48	27.04	31.33	31.49
2025	31.02	31.13	29.68	28.71	28.86	28.97	29.14	29.30	29.45	29.63	36.41	36.72
2026	38.12	38.24	35.71	34.22	34.16	34.30	34.50	34.69	34.85	35.30	41.97	41.66
2027	38.89	38.80	37.17	35.15	34.92	35.06	35.03	35.35	35.50	36.00	43.42	43.18
2028	40.43	40.42	39.07	36.57	36.40	36.57	36.42	36.75	37.06	37.76	45.77	44.65
2029	44.23	44.16	41.40	38.91	38.14	38.32	37.88	38.23	38.78	39.51	48.54	48.28
2030	46.80	46.74	44.07	41.82	41.60	41.77	41.81	42.20	42.32	42.88	51.62	51.90
2031	47.78	47.72	44.99	42.70	42.47	42.65	42.69	43.09	43.21	43.78	52.69	52.98
2032	51.38	51.33	48.10	45.71	45.49	45.68	45.76	46.18	46.29	46.89	56.39	56.94
2033	52.77	52.72	49.38	46.93	46.71	46.90	46.99	47.42	47.53	48.14	57.88	58.47
2034	54.12	54.08	50.61	48.10	47.88	48.08	48.17	48.62	48.73	49.35	59.34	59.97
2035	55.66	55.62	52.02	49.46	49.23	49.44	49.54	50.00	50.10	50.74	60.98	61.65
2036	57.04	56.99	53.33	50.72	50.49	50.70	50.80	51.26	51.37	52.02	62.46	63.15
2037	58.43	58.38	54.65	51.99	51.75	51.97	52.06	52.54	52.65	53.32	63.95	64.65
2038	59.88	59.84	56.03	53.32	53.08	53.30	53.40	53.88	54.00	54.67	65.52	66.23
2039	61.13	61.08	57.20	54.44	54.19	54.42	54.52	55.02	55.13	55.82	66.87	67.60
2040	62.75	62.70	58.75	55.93	55.68	55.91	56.01	56.52	56.64	57.34	68.60	69.34
2041	64.04	63.98	59.95	57.08	56.83	57.06	57.17	57.68	57.80	58.52	70.00	70.76

SCHEDULE 201 (Continued)PRICING OPTIONS FOR STANDARD PPA (Continued)
Standard Fixed Price Option (Continued)

TABLE 3a												
Avoided Costs												
Standard Fixed Price Option for Solar QF												
On-Peak Forecast (\$/MWH)												
Year	Jan	Feb	Mar	Apr	May	Jun	Jul	Aug	Sep	Oct	Nov	Dec
2016	28.21	22.46	15.61	14.71	12.46	16.96	23.96	26.96	24.96	23.71	26.71	31.46
2017	29.96	28.21	24.71	20.96	19.46	20.46	27.96	30.96	29.46	27.71	28.71	33.71
2018	31.71	31.11	28.11	22.13	21.28	21.28	29.93	33.37	30.63	28.61	31.86	35.71
2019	33.94	31.95	27.97	23.70	22.00	23.13	31.67	35.08	33.37	31.38	32.52	38.21
2020	35.74	33.64	29.45	24.95	23.15	24.35	33.34	36.94	35.14	33.04	34.24	40.24
2021	33.98	33.89	31.96	31.24	30.96	31.05	31.16	31.28	31.39	32.03	35.15	35.27
2022	34.92	34.75	33.98	33.04	32.72	32.82	32.94	33.08	33.20	33.74	37.28	37.61
2023	37.09	36.90	35.52	34.32	34.21	34.31	34.44	34.58	34.71	35.26	38.69	38.83
2024	38.86	38.54	37.36	35.98	35.79	35.90	36.04	36.19	36.32	36.88	41.18	41.33
2025	41.08	41.19	39.73	38.77	38.92	39.03	39.19	39.36	39.51	39.69	46.46	46.78
2026	48.37	48.49	45.97	44.48	44.42	44.56	44.75	44.94	45.10	45.56	52.22	51.91
2027	49.34	49.25	47.62	45.61	45.38	45.51	45.48	45.81	45.95	46.45	53.87	53.63
2028	51.08	51.07	49.72	47.22	47.06	47.22	47.07	47.40	47.72	48.41	56.42	55.31
2029	55.08	55.01	52.26	49.77	48.99	49.17	48.73	49.08	49.63	50.36	59.40	59.13
2030	57.87	57.81	55.14	52.89	52.67	52.84	52.88	53.27	53.39	53.95	62.69	62.97
2031	59.07	59.00	56.28	53.98	53.76	53.93	53.98	54.37	54.49	55.06	63.98	64.26
2032	62.83	62.78	59.56	57.16	56.94	57.13	57.21	57.64	57.75	58.34	67.85	68.39
2033	64.49	64.44	61.09	58.64	58.42	58.62	58.70	59.14	59.25	59.86	69.60	70.18
2034	66.10	66.05	62.58	60.08	59.85	60.05	60.14	60.59	60.70	61.32	71.31	71.94
2035	67.84	67.79	64.20	61.64	61.41	61.62	61.71	62.17	62.28	62.92	73.16	73.83
2036	69.43	69.38	65.72	63.11	62.88	63.09	63.19	63.66	63.77	64.42	74.85	75.54
2037	71.08	71.04	67.30	64.64	64.40	64.62	64.72	65.20	65.31	65.97	76.61	77.31
2038	72.78	72.73	68.93	66.22	65.98	66.20	66.30	66.78	66.90	67.57	78.42	79.13
2039	74.28	74.23	70.35	67.58	67.34	67.56	67.67	68.16	68.28	68.97	80.02	80.75
2040	76.15	76.10	72.15	69.33	69.08	69.31	69.42	69.92	70.04	70.74	82.01	82.75
2041	77.69	77.64	73.61	70.74	70.48	70.72	70.82	71.34	71.46	72.17	83.66	84.41

SCHEDULE 201 (Continued)PRICING OPTIONS FOR STANDARD PPA (Continued)
Standard Fixed Price Option (Continued)

TABLE 3b												
Avoided Costs												
Standard Fixed Price Option for Solar QF												
Off-Peak Forecast (\$/MWH)												
Year	Jan	Feb	Mar	Apr	May	Jun	Jul	Aug	Sep	Oct	Nov	Dec
2016	25.61	20.71	13.96	11.41	6.31	10.11	15.71	20.96	20.96	21.21	23.46	26.71
2017	25.71	24.21	22.21	15.71	13.71	12.71	19.71	25.21	25.46	24.71	25.71	27.96
2018	26.17	28.12	25.56	19.46	14.68	12.54	19.71	27.04	26.93	25.35	28.20	30.62
2019	29.84	28.09	25.75	18.15	15.81	14.64	22.83	29.26	29.55	28.67	29.84	32.47
2020	31.75	29.88	27.38	19.28	16.79	15.54	24.27	31.12	31.43	30.50	31.75	34.55
2021	28.88	28.79	26.86	26.15	25.87	25.95	26.07	26.19	26.30	26.94	30.06	30.18
2022	29.73	29.56	28.79	27.85	27.53	27.63	27.75	27.88	28.00	28.54	32.09	32.42
2023	31.78	31.59	30.21	29.01	28.90	29.00	29.14	29.27	29.40	29.95	33.38	33.52
2024	33.48	33.16	31.98	30.60	30.41	30.52	30.66	30.81	30.95	31.51	35.80	35.96
2025	35.58	35.69	34.24	33.27	33.42	33.53	33.70	33.86	34.01	34.19	40.97	41.28
2026	42.77	42.89	40.36	38.87	38.81	38.95	39.15	39.34	39.50	39.95	46.62	46.31
2027	43.63	43.54	41.91	39.89	39.66	39.80	39.77	40.09	40.24	40.74	48.16	47.92
2028	45.26	45.25	43.90	41.40	41.23	41.40	41.25	41.58	41.89	42.59	50.60	49.48
2029	49.15	49.08	46.32	43.83	43.06	43.24	42.80	43.15	43.70	44.43	53.46	53.20
2030	51.82	51.76	49.09	46.84	46.62	46.79	46.83	47.22	47.34	47.90	56.64	56.92
2031	52.90	52.84	50.11	47.82	47.59	47.77	47.81	48.21	48.33	48.90	57.81	58.10
2032	56.59	56.54	53.31	50.92	50.70	50.89	50.97	51.39	51.50	52.10	61.60	62.15
2033	58.08	58.03	54.69	52.24	52.02	52.21	52.30	52.73	52.84	53.45	63.19	63.78
2034	59.54	59.50	56.03	53.52	53.30	53.50	53.59	54.04	54.15	54.77	64.76	65.39
2035	61.18	61.14	57.54	54.98	54.75	54.96	55.06	55.52	55.62	56.26	66.50	67.17
2036	62.67	62.62	58.96	56.35	56.12	56.33	56.43	56.89	57.00	57.65	68.09	68.78
2037	64.17	64.12	60.39	57.73	57.49	57.71	57.80	58.28	58.39	59.06	69.69	70.39
2038	65.73	65.69	61.88	59.17	58.93	59.15	59.25	59.73	59.85	60.52	71.37	72.08
2039	67.09	67.04	63.16	60.40	60.15	60.38	60.48	60.98	61.09	61.78	72.83	73.56
2040	68.83	68.78	64.83	62.01	61.76	61.99	62.09	62.60	62.72	63.42	74.68	75.42
2041	70.23	70.17	66.14	63.27	63.02	63.25	63.36	63.87	63.99	64.71	76.19	76.95

SCHEDULE 201 (Continued)

PRICING OPTIONS FOR STANDARD PPA (Continued)

2) Renewable Fixed Price Option

The Renewable Fixed Price Option is based on Renewable Avoided Costs. It is available only to Renewable QFs that generate electricity from a renewable energy source that may be used by the Company to comply with the Oregon Renewable Portfolio Standard as set forth in ORS 469A.005 to 469A.210.

This option is available for a maximum term of 15 years. Prices will be as established at the time the Standard PPA is executed and will be equal to the Renewable Avoided Costs in Tables 4a and 4b, 5a and 5b, or 6a and 6b, depending on the type of QF, effective at execution. QFs using any resource type other than wind and solar are assumed to be Base Load QFs.

Sellers will retain all Environmental Attributes generated by the facility during the Renewable Resource Sufficiency Period. A Renewable QF choosing the Renewable Fixed Price Option must cede all RPS Attributes generated by the facility to the Company from the start of the Renewable Resource Deficiency Period through the remainder of the PPA term.

Prices paid to the Seller under the Renewable Fixed Price Option include adjustments for the capacity contribution of the QF resource type relative to that of the avoided proxy resource. Both Wind QF resources (Tables 5a and 5b) and the avoided proxy resource, the basis used to determine Renewable Avoided Costs for the Renewable Fixed Price Option, are assumed to have a capacity contribution to peak of 5%. The capacity contribution for Solar QF resources (Tables 6a and 6b) is assumed to be 5%. The capacity contribution for Base Load QF resources (Tables 4a and 4b) is assumed to be 100%.

The Renewable Avoided Costs during the Renewable Resource Deficiency Period reflect an increase for avoided wind integration costs, shown in Table 7.

Prices paid to the Seller under the Renewable Fixed Price Option for Wind QFs (Tables 5a and 5b) include a reduction for the wind integration costs in Table 7, which cancels out wind integration costs included in the Renewable Avoided Costs during the Renewable Resource Deficiency Period. However, if the Wind QF is outside of PGE's Balancing Authority Area as contemplated in the Commission's Order No. 14-058, the Seller is paid the wind integration charges in Table 7, in addition to the prices listed in Tables 5a and 5b.

Sellers with PPAs exceeding 15 years will receive pricing equal to the Mid-C Index Price for all years up to five in excess of the initial 15.

SCHEDULE 201 (Continued)PRICING OPTIONS FOR STANDARD PPA (Continued)
Renewable Fixed Price Option (Continued)

TABLE 4a												
Renewable Avoided Costs												
Renewable Fixed Price Option for Base Load QF												
On-Peak Forecast (\$/MWH)												
Year	Jan	Feb	Mar	Apr	May	Jun	Jul	Aug	Sep	Oct	Nov	Dec
2016	28.36	22.61	15.76	14.86	12.61	17.11	24.11	27.11	25.11	23.86	26.86	31.61
2017	30.11	28.36	24.86	21.11	19.61	20.61	28.11	31.11	29.61	27.86	28.86	33.86
2018	31.86	31.26	28.26	22.28	21.43	21.43	30.08	33.52	30.78	28.76	32.01	35.86
2019	34.10	32.11	28.13	23.86	22.16	23.29	31.83	35.24	33.53	31.54	32.68	38.37
2020	115.34	115.32	114.56	115.02	118.22	117.33	117.01	116.89	115.60	114.63	115.47	114.45
2021	117.94	118.18	116.67	117.75	120.59	119.83	119.26	119.77	118.26	117.25	118.55	117.22
2022	120.48	120.36	118.46	120.19	123.17	122.14	121.69	121.65	120.55	119.55	120.98	119.53
2023	123.26	122.83	120.85	122.92	125.37	124.64	124.29	123.92	123.08	121.92	123.63	122.53
2024	124.86	125.01	123.06	125.07	127.80	126.78	126.67	126.41	126.22	123.83	124.83	124.96
2025	127.73	128.05	125.86	128.21	131.66	130.48	129.53	129.66	128.84	126.59	127.76	127.41
2026	130.91	130.58	129.12	131.30	135.76	132.28	132.28	132.69	132.40	129.34	131.17	130.23
2027	133.47	133.03	131.38	133.50	139.48	134.88	134.51	135.95	134.79	131.96	133.26	132.78
2028	135.95	134.91	132.89	136.24	141.79	136.93	137.64	137.65	136.77	134.76	135.84	135.06
2029	138.81	138.57	135.91	139.29	149.30	140.74	140.82	140.82	140.86	137.50	138.32	138.21
2030	141.68	141.39	139.11	142.00	153.18	145.20	143.05	142.93	144.31	140.18	140.75	140.79
2031	144.29	143.79	142.17	145.52	156.10	149.27	145.71	146.65	146.86	143.04	144.15	143.71
2032	146.51	146.00	144.35	147.76	158.51	151.58	147.95	148.91	149.13	145.24	146.37	145.92
2033	149.91	149.40	147.71	151.19	162.18	155.09	151.39	152.37	152.59	148.62	149.77	149.31
2034	152.96	152.43	150.71	154.26	165.46	158.24	154.46	155.46	155.68	151.64	152.81	152.35
2035	155.76	155.22	153.46	157.08	168.50	161.14	157.29	158.31	158.54	154.41	155.60	155.13
2036	158.31	157.76	155.97	159.65	171.26	163.78	159.86	160.90	161.13	156.94	158.15	157.67
2037	161.83	161.27	159.44	163.20	175.07	167.42	163.42	164.48	164.71	160.43	161.67	161.18
2038	164.95	164.38	162.52	166.35	178.45	170.65	166.57	167.65	167.89	163.52	164.79	164.29
2039	168.13	167.55	165.66	169.56	181.89	173.94	169.79	170.89	171.13	166.68	167.97	167.46
2040	171.05	170.46	168.54	172.51	185.04	176.96	172.74	173.85	174.10	169.58	170.89	170.37
2041	174.69	174.08	172.11	176.17	188.98	180.72	176.40	177.55	177.80	173.18	174.52	173.99

SCHEDULE 201 (Continued)PRICING OPTIONS FOR STANDARD PPA (Continued)
Renewable Fixed Price Option (Continued)

TABLE 4b												
Renewable Avoided Costs												
Renewable Fixed Price Option for Base Load QF												
Off-Peak Forecast (\$/MWH)												
Year	Jan	Feb	Mar	Apr	May	Jun	Jul	Aug	Sep	Oct	Nov	Dec
2016	25.76	20.86	14.11	11.56	6.46	10.26	15.86	21.11	21.11	21.36	23.61	26.86
2017	25.86	24.36	22.36	15.86	13.86	12.86	19.86	25.36	25.61	24.86	25.86	28.11
2018	26.32	28.27	25.71	19.61	14.83	12.69	19.86	27.19	27.08	25.50	28.35	30.77
2019	30.00	28.25	25.91	18.31	15.97	14.80	22.99	29.42	29.71	28.83	30.00	32.63
2020	62.76	63.02	64.56	63.31	59.92	60.16	60.45	61.61	62.52	63.74	63.55	63.99
2021	64.93	64.15	65.85	64.48	61.58	61.62	62.27	62.62	63.78	65.82	63.38	65.09
2022	65.85	65.52	67.77	65.49	62.45	62.82	64.33	63.35	65.00	67.04	64.42	66.29
2023	66.70	66.75	69.10	67.28	62.84	64.01	65.40	64.85	66.14	68.41	65.38	67.63
2024	67.25	67.31	70.47	67.09	63.18	65.92	64.75	65.12	66.62	68.68	67.42	68.05
2025	68.62	68.60	71.94	68.08	63.17	66.28	66.12	67.12	67.23	70.19	69.68	69.06
2026	68.95	69.85	72.28	68.56	63.85	67.22	67.05	67.75	67.05	71.12	69.85	69.89
2027	71.31	71.29	73.13	70.34	63.69	68.45	68.79	68.16	68.57	73.22	70.67	71.18
2028	72.28	72.90	75.41	72.10	63.09	69.98	70.15	68.82	70.20	73.79	71.48	73.41
2029	72.78	73.60	76.79	73.50	58.25	70.29	71.37	70.00	71.53	74.58	73.61	74.68
2030	73.91	74.82	78.36	73.64	58.00	70.89	72.02	72.19	72.00	75.99	75.36	76.23
2031	75.51	76.70	79.40	74.00	59.17	70.67	73.55	73.71	72.16	77.24	77.07	76.31
2032	76.76	77.97	80.71	75.23	60.15	71.83	74.76	74.93	73.35	78.52	78.34	77.57
2033	78.46	79.69	82.50	76.89	61.48	73.42	76.42	76.58	74.97	80.25	80.07	79.29
2034	79.97	81.23	84.09	78.37	62.66	74.84	77.89	78.06	76.42	81.80	81.62	80.82
2035	81.52	82.80	85.71	79.88	63.87	76.28	79.39	79.57	77.89	83.38	83.19	82.38
2036	82.86	84.17	87.13	81.20	64.93	77.54	80.70	80.88	79.18	84.76	84.57	83.74
2037	84.69	86.03	89.05	83.00	66.36	79.25	82.49	82.67	80.93	86.63	86.44	85.59
2038	86.33	87.69	90.77	84.60	67.64	80.78	84.08	84.26	82.49	88.30	88.11	87.24
2039	87.99	89.38	92.52	86.23	68.95	82.34	85.70	85.89	84.08	90.01	89.81	88.92
2040	89.45	90.85	94.05	87.66	70.09	83.70	87.12	87.31	85.47	91.49	91.29	90.39
2041	91.42	92.86	96.13	89.59	71.63	85.55	89.04	89.24	87.36	93.51	93.31	92.39

SCHEDULE 201 (Continued)PRICING OPTIONS FOR STANDARD PPA (Continued)
Renewable Fixed Price Option (Continued)

TABLE 5a												
Renewable Avoided Costs												
Renewable Fixed Price Option for Wind QF												
On-Peak Forecast (\$/MWH)												
Year	Jan	Feb	Mar	Apr	May	Jun	Jul	Aug	Sep	Oct	Nov	Dec
2016	24.52	18.77	11.92	11.02	8.77	13.27	20.27	23.27	21.27	20.02	23.02	27.77
2017	26.20	24.45	20.95	17.20	15.70	16.70	24.20	27.20	25.70	23.95	24.95	29.95
2018	27.87	27.27	24.27	18.29	17.44	17.44	26.09	29.53	26.79	24.77	28.02	31.87
2019	30.03	28.04	24.06	19.79	18.09	19.22	27.76	31.17	29.46	27.47	28.61	34.30
2020	75.38	75.37	74.61	75.06	78.26	77.37	77.05	76.93	75.64	74.67	75.51	74.49
2021	77.10	77.33	75.83	76.90	79.75	78.99	78.41	78.92	77.41	76.40	77.70	76.38
2022	78.85	78.72	76.82	78.56	81.53	80.51	80.05	80.02	78.92	77.92	79.34	77.90
2023	80.71	80.27	78.29	80.37	82.82	82.08	81.73	81.37	80.53	79.36	81.08	79.97
2024	81.74	81.89	79.93	81.95	84.68	83.66	83.55	83.28	83.10	80.71	81.71	81.84
2025	83.64	83.97	81.78	84.13	87.57	86.40	85.44	85.57	84.75	82.51	83.68	83.32
2026	85.97	85.64	84.18	86.37	90.82	87.34	87.34	87.75	87.46	84.40	86.23	85.29
2027	87.67	87.23	85.57	87.69	93.67	89.07	88.71	90.15	88.99	86.16	87.45	86.98
2028	89.26	88.22	86.20	89.55	95.10	90.24	90.95	90.96	90.08	88.07	89.15	88.37
2029	91.22	90.98	88.32	91.70	101.72	93.16	93.23	93.23	93.28	89.92	90.73	90.62
2030	93.17	92.88	90.60	93.49	104.67	96.69	94.54	94.42	95.80	91.67	92.24	92.28
2031	94.84	94.34	92.72	96.07	106.65	99.82	96.26	97.20	97.42	93.59	94.70	94.26
2032	96.40	95.90	94.24	97.65	108.40	101.47	97.85	98.80	99.02	95.13	96.26	95.82
2033	98.55	98.03	96.34	99.82	110.81	103.72	100.02	101.00	101.22	97.25	98.40	97.95
2034	100.44	99.91	98.19	101.74	112.94	105.72	101.94	102.94	103.17	99.12	100.29	99.83
2035	102.38	101.85	100.09	103.71	115.13	107.76	103.92	104.93	105.16	101.04	102.23	101.76
2036	104.06	103.51	101.72	105.40	117.01	109.53	105.61	106.65	106.88	102.69	103.90	103.42
2037	106.37	105.81	103.99	107.74	119.61	111.96	107.96	109.02	109.26	104.97	106.21	105.72
2038	108.42	107.86	105.99	109.82	121.92	114.12	110.05	111.12	111.37	107.00	108.26	107.76
2039	110.52	109.94	108.04	111.95	124.27	116.33	112.17	113.27	113.52	109.07	110.36	109.85
2040	112.32	111.73	109.81	113.77	126.31	118.23	114.00	115.12	115.37	110.85	112.16	111.64
2041	114.83	114.23	112.26	116.31	129.12	120.86	116.55	117.69	117.95	113.32	114.66	114.13

SCHEDULE 201 (Continued)PRICING OPTIONS FOR STANDARD PPA (Continued)
Renewable Fixed Price Option (Continued)

TABLE 5b												
Renewable Avoided Costs												
Renewable Fixed Price Option for Wind QF												
Off-Peak Forecast (\$/MWH)												
Year	Jan	Feb	Mar	Apr	May	Jun	Jul	Aug	Sep	Oct	Nov	Dec
2016	21.92	17.02	10.27	7.72	2.62	6.42	12.02	17.27	17.27	17.52	19.77	23.02
2017	21.95	20.45	18.45	11.95	9.95	8.95	15.95	21.45	21.70	20.95	21.95	24.20
2018	22.33	24.28	21.72	15.62	10.84	8.70	15.87	23.20	23.09	21.51	24.36	26.78
2019	25.93	24.18	21.84	14.24	11.90	10.73	18.92	25.35	25.64	24.76	25.93	28.56
2020	58.61	58.87	60.41	59.16	55.77	56.01	56.30	57.46	58.37	59.59	59.40	59.84
2021	60.70	59.92	61.62	60.25	57.35	57.39	58.04	58.39	59.55	61.59	59.15	60.86
2022	61.54	61.21	63.46	61.18	58.14	58.51	60.02	59.04	60.69	62.73	60.11	61.98
2023	62.31	62.36	64.71	62.89	58.45	59.62	61.01	60.46	61.75	64.02	60.99	63.24
2024	62.78	62.84	66.00	62.62	58.71	61.45	60.28	60.65	62.15	64.21	62.95	63.58
2025	64.06	64.04	67.38	63.52	58.61	61.72	61.56	62.56	62.67	65.63	65.12	64.50
2026	64.30	65.20	67.63	63.91	59.20	62.57	62.40	63.10	62.40	66.47	65.20	65.24
2027	66.57	66.55	68.39	65.60	58.95	63.71	64.05	63.42	63.83	68.48	65.93	66.44
2028	67.45	68.07	70.58	67.27	58.26	65.15	65.32	63.99	65.37	68.96	66.65	68.58
2029	67.86	68.68	71.87	68.58	53.33	65.37	66.45	65.08	66.61	69.66	68.69	69.76
2030	68.89	69.80	73.34	68.62	52.98	65.87	67.00	67.17	66.98	70.97	70.34	71.21
2031	70.39	71.58	74.28	68.88	54.05	65.55	68.43	68.59	67.04	72.12	71.95	71.19
2032	71.55	72.76	75.50	70.02	54.94	66.62	69.55	69.72	68.14	73.31	73.13	72.36
2033	73.15	74.38	77.19	71.58	56.17	68.11	71.11	71.27	69.66	74.94	74.76	73.98
2034	74.55	75.81	78.67	72.95	57.24	69.42	72.47	72.64	71.00	76.38	76.20	75.40
2035	76.00	77.28	80.19	74.36	58.35	70.76	73.87	74.05	72.37	77.86	77.67	76.86
2036	77.23	78.54	81.50	75.57	59.30	71.91	75.07	75.25	73.55	79.13	78.94	78.11
2037	78.95	80.29	83.31	77.26	60.62	73.51	76.75	76.93	75.19	80.89	80.70	79.85
2038	80.48	81.84	84.92	78.75	61.79	74.93	78.23	78.41	76.64	82.45	82.26	81.39
2039	82.03	83.42	86.56	80.27	62.99	76.38	79.74	79.93	78.12	84.05	83.85	82.96
2040	83.37	84.77	87.97	81.58	64.01	77.62	81.04	81.23	79.39	85.41	85.21	84.31
2041	85.23	86.67	89.94	83.40	65.44	79.36	82.85	83.05	81.17	87.32	87.12	86.20

SCHEDULE 201 (Continued)PRICING OPTIONS FOR STANDARD PPA (Continued)
Renewable Fixed Price Option (Continued)

TABLE 6a												
Renewable Avoided Costs												
Renewable Fixed Price Option for Solar QF												
On-Peak Forecast (\$/MWH)												
Year	Jan	Feb	Mar	Apr	May	Jun	Jul	Aug	Sep	Oct	Nov	Dec
2016	28.36	22.61	15.76	14.86	12.61	17.11	24.11	27.11	25.11	23.86	26.86	31.61
2017	30.11	28.36	24.86	21.11	19.61	20.61	28.11	31.11	29.61	27.86	28.86	33.86
2018	31.86	31.26	28.26	22.28	21.43	21.43	30.08	33.52	30.78	28.76	32.01	35.86
2019	34.10	32.11	28.13	23.86	22.16	23.29	31.83	35.24	33.53	31.54	32.68	38.37
2020	78.62	78.60	77.84	78.30	81.50	80.60	80.29	80.17	78.88	77.91	78.74	77.73
2021	80.39	80.63	79.12	80.20	83.04	82.28	81.71	82.22	80.71	79.70	81.00	79.67
2022	82.21	82.08	80.18	81.92	84.89	83.87	83.41	83.38	82.27	81.27	82.70	81.25
2023	84.12	83.69	81.71	83.78	86.23	85.50	85.15	84.78	83.94	82.78	84.50	83.39
2024	85.22	85.37	83.41	85.43	88.16	87.14	87.03	86.76	86.58	84.19	85.19	85.32
2025	87.19	87.52	85.33	87.68	91.12	89.95	88.99	89.12	88.30	86.06	87.23	86.87
2026	89.59	89.26	87.80	89.99	94.44	90.96	90.96	91.37	91.08	88.02	89.85	88.91
2027	91.36	90.92	89.26	91.39	97.36	92.76	92.40	93.84	92.68	89.85	91.14	90.67
2028	93.02	91.98	89.96	93.31	98.86	94.00	94.71	94.72	93.84	91.84	92.91	92.13
2029	95.05	94.81	92.15	95.53	105.55	96.99	97.06	97.06	97.11	93.75	94.56	94.45
2030	97.08	96.79	94.51	97.40	108.58	100.60	98.45	98.33	99.71	95.58	96.15	96.19
2031	98.83	98.33	96.70	100.05	110.63	103.81	100.25	101.19	101.40	97.58	98.69	98.25
2032	100.47	99.96	98.30	101.71	112.47	105.53	101.91	102.87	103.08	99.20	100.32	99.88
2033	102.68	102.16	100.47	103.95	114.95	107.86	104.16	105.14	105.36	101.38	102.53	102.08
2034	104.66	104.13	102.41	105.96	117.16	109.94	106.16	107.16	107.38	103.34	104.51	104.05
2035	106.68	106.15	104.39	108.01	119.43	112.06	108.21	109.23	109.46	105.34	106.53	106.06
2036	108.44	107.90	106.11	109.79	121.40	113.91	110.00	111.04	111.27	107.08	108.29	107.81
2037	110.84	110.28	108.46	112.21	124.08	116.43	112.43	113.49	113.73	109.44	110.68	110.19
2038	112.98	112.41	110.55	114.38	126.47	118.68	114.60	115.68	115.92	111.55	112.82	112.32
2039	115.16	114.58	112.68	116.59	128.92	120.97	116.81	117.91	118.16	113.71	115.00	114.49
2040	117.06	116.47	114.54	118.51	131.04	122.96	118.74	119.86	120.11	115.58	116.89	116.37
2041	119.65	119.05	117.07	121.13	133.94	125.68	121.37	122.51	122.76	118.14	119.48	118.95

SCHEDULE 201 (Continued)PRICING OPTIONS FOR STANDARD PPA (Continued)
Renewable Fixed Price Option (Continued)

TABLE 6b												
Renewable Avoided Costs												
Renewable Fixed Price Option for Solar QF												
Off-Peak Forecast (\$/MWH)												
Year	Jan	Feb	Mar	Apr	May	Jun	Jul	Aug	Sep	Oct	Nov	Dec
2016	25.76	20.86	14.11	11.56	6.46	10.26	15.86	21.11	21.11	21.36	23.61	26.86
2017	25.86	24.36	22.36	15.86	13.86	12.86	19.86	25.36	25.61	24.86	25.86	28.11
2018	26.32	28.27	25.71	19.61	14.83	12.69	19.86	27.19	27.08	25.50	28.35	30.77
2019	30.00	28.25	25.91	18.31	15.97	14.80	22.99	29.42	29.71	28.83	30.00	32.63
2020	62.76	63.02	64.56	63.31	59.92	60.16	60.45	61.61	62.52	63.74	63.55	63.99
2021	64.93	64.15	65.85	64.48	61.58	61.62	62.27	62.62	63.78	65.82	63.38	65.09
2022	65.85	65.52	67.77	65.49	62.45	62.82	64.33	63.35	65.00	67.04	64.42	66.29
2023	66.70	66.75	69.10	67.28	62.84	64.01	65.40	64.85	66.14	68.41	65.38	67.63
2024	67.25	67.31	70.47	67.09	63.18	65.92	64.75	65.12	66.62	68.68	67.42	68.05
2025	68.62	68.60	71.94	68.08	63.17	66.28	66.12	67.12	67.23	70.19	69.68	69.06
2026	68.95	69.85	72.28	68.56	63.85	67.22	67.05	67.75	67.05	71.12	69.85	69.89
2027	71.31	71.29	73.13	70.34	63.69	68.45	68.79	68.16	68.57	73.22	70.67	71.18
2028	72.28	72.90	75.41	72.10	63.09	69.98	70.15	68.82	70.20	73.79	71.48	73.41
2029	72.78	73.60	76.79	73.50	58.25	70.29	71.37	70.00	71.53	74.58	73.61	74.68
2030	73.91	74.82	78.36	73.64	58.00	70.89	72.02	72.19	72.00	75.99	75.36	76.23
2031	75.51	76.70	79.40	74.00	59.17	70.67	73.55	73.71	72.16	77.24	77.07	76.31
2032	76.76	77.97	80.71	75.23	60.15	71.83	74.76	74.93	73.35	78.52	78.34	77.57
2033	78.46	79.69	82.50	76.89	61.48	73.42	76.42	76.58	74.97	80.25	80.07	79.29
2034	79.97	81.23	84.09	78.37	62.66	74.84	77.89	78.06	76.42	81.80	81.62	80.82
2035	81.52	82.80	85.71	79.88	63.87	76.28	79.39	79.57	77.89	83.38	83.19	82.38
2036	82.86	84.17	87.13	81.20	64.93	77.54	80.70	80.88	79.18	84.76	84.57	83.74
2037	84.69	86.03	89.05	83.00	66.36	79.25	82.49	82.67	80.93	86.63	86.44	85.59
2038	86.33	87.69	90.77	84.60	67.64	80.78	84.08	84.26	82.49	88.30	88.11	87.24
2039	87.99	89.38	92.52	86.23	68.95	82.34	85.70	85.89	84.08	90.01	89.81	88.92
2040	89.45	90.85	94.05	87.66	70.09	83.70	87.12	87.31	85.47	91.49	91.29	90.39
2041	91.42	92.86	96.13	89.59	71.63	85.55	89.04	89.24	87.36	93.51	93.31	92.39

SCHEDULE 201 (Continued)

WIND INTEGRATION

TABLE 7	
Wind Integration	
Year	Cost
2015	3.77
2016	3.84
2017	3.91
2018	3.99
2019	4.07
2020	4.15
2021	4.23
2022	4.31
2023	4.39
2024	4.47
2025	4.56
2026	4.65
2027	4.74
2028	4.83
2029	4.92
2030	5.02
2031	5.12
2032	5.21
2033	5.31
2034	5.42
2035	5.52
2036	5.63
2037	5.74
2038	5.85
2039	5.96
2040	6.08

SCHEDULE 201 (Continued)**MONTHLY SERVICE CHARGE**

Each separately metered QF not associated with a retail Customer account will be charged \$10.00 per month.

INSURANCE REQUIREMENTS

The following insurance requirements are applicable to Sellers with a Standard PPA:

- 1) QFs with nameplate capacity ratings greater than 200 kW are required to secure and maintain a prudent amount of general liability insurance. The Seller must certify to the Company that it is maintaining general liability insurance coverage for each QF at prudent amounts. A prudent amount will be deemed to mean liability insurance coverage for both bodily injury and property damage liability in the amount of not less than \$1,000,000 each occurrence combined single limit, which limits may be required to be increased or decreased by the Company as the Company determines in its reasonable judgment, that economic conditions or claims experience may warrant.
- 2) Such insurance will include an endorsement naming the Company as an additional insured insofar as liability arising out of operations under this schedule and a provision that such liability policies will not be canceled or their limits reduced without 30 days' written notice to the Company. The Seller will furnish the Company with certificates of insurance together with the endorsements required herein. The Company will have the right to inspect the original policies of such insurance.
- 3) QFs with a design capacity of 200 kW or less are encouraged to pursue liability insurance on their own. The Oregon Public Utility Commission in Order No. 05-584 determined that it is inappropriate to require QFs that have a design capacity of 200 kW or less to obtain general liability insurance.

TRANSMISSION AGREEMENTS

If the QF is located outside the Company's service territory, the Seller is responsible for the transmission of power at its cost to the Company's service territory.

INTERCONNECTION REQUIREMENTS

Except as otherwise provided in a generation Interconnection Agreement between the Company and Seller, if the QF is located within the Company's service territory, switching equipment capable of isolating the QF from the Company's system will be accessible to the Company at all times. At the Company's option, the Company may operate the switching equipment described above if, in the sole opinion of the Company, continued operation of the QF in connection with the utility's system may create or contribute to a system emergency.

SCHEDULE 201 (Continued)**INTERCONNECTION REQUIREMENTS (Continued)**

The QF owner interconnecting with the Company's distribution system must comply with all requirements for interconnection as established pursuant to Commission rule, in the Company's Rules and Regulations (Rule C) or the Company's Interconnection Procedures contained in its FERC Open Access Transmission Tariff (OATT), as applicable. The Seller will bear full responsibility for the installation and safe operation of the interconnection facilities.

DEFINITION OF A SMALL COGENERATION FACILITY OR SMALL POWER PRODUCTION FACILITY ELIGIBLE TO RECEIVE PRICING UNDER THE STANDARD PPA

A QF will be eligible to receive pricing under the Standard PPA if the nameplate capacity of the QF, together with any other electric generating facility using the same motive force, owned or controlled by the Same Person(s) or Affiliated Person(s), and located at the Same Site, does not exceed 10 MW. A Community-Based or Family-Owned QF is exempt from these restrictions.

Definition of Community-Based

- a. A community project (or a community sponsored project) must have a recognized and established organization located within the county of the project or within 50 miles of the project that has a genuine role in helping the project be developed and must have some not insignificant continuing role with or interest in the project after it is completed and placed in service.
- b. After excluding the passive investor whose ownership interests are primarily related to green tag values and tax benefits as the primary ownership benefit, the equity (ownership) interests in a community sponsored project must be owned in substantial percentage (80 percent or more) by the following persons (individuals and entities): (i) the sponsoring organization, or its controlled affiliates; (ii) members of the sponsoring organization (if it is a membership organization) or owners of the sponsorship organization (if it is privately owned); (iii) persons who live in the county in which the project is located or who live a county adjoining the county in which the project is located; or (iv) units of local government, charities, or other established nonprofit organizations active either in the county in which the project is located or active in a county adjoining the county in which the project is located.

Definition of Family-Owned

After excluding the ownership interest of the passive investor whose ownership interests are primarily related to green tag values and tax benefits as the primary ownership benefit, five or fewer individuals own 50 percent or more of the equity of the project entity, or fifteen or fewer individuals own 90 percent or more of the project entity. A "look through" rule applies to closely held entities that hold the project entity, so that equity held by LLCs, trusts, estates, corporations, partnerships or other similar entities is considered held by the equity owners of the look through entity. An individual is a natural person. In counting to five or fifteen, spouses or children of an equity owner of the project owner who also have an equity interest are aggregated and counted as a single individual.

SCHEDULE 201 (Continued)**DEFINITION OF A SMALL COGENERATION FACILITY OR SMALL POWER PRODUCTION FACILITY ELIGIBLE TO RECEIVE PRICING UNDER THE STANDARD PPA (Continued)****Definition of Person(s) or Affiliated Person(s)**

As used above, the term “Same Person(s)” or “Affiliated Person(s)” means a natural person or persons or any legal entity or entities sharing common ownership, management or acting jointly or in concert with or exercising influence over the policies or actions of another person or entity. However, two facilities will not be held to be owned or controlled by the Same Person(s) or Affiliated Person(s) solely because they are developed by a single entity.

Furthermore, two facilities will not be held to be owned or controlled by the Same Person(s) or Affiliated Person(s) if such common person or persons is a “passive investor” whose ownership interest in the QF is primarily related to utilizing production tax credits, green tag values and MACRS depreciation as the primary ownership benefit and the facilities at issue are independent family-owned or community-based projects. A unit of Oregon local government may also be a “passive investor” in a community-based project if the local governmental unit demonstrates that it will not have an equity ownership interest in or exercise any control over the management of the QF and that its only interest is a share of the cash flow from the QF, which share will not exceed 20%. The 20% cash flow share limit may only be exceeded for good cause shown and only with the prior approval of the Commission.

Definition of Same Site

For purposes of the foregoing, generating facilities are considered to be located at the same site as the QF for which qualification for pricing under the Standard PPA is sought if they are located within a five-mile radius of any generating facilities or equipment providing fuel or motive force associated with the QF for which qualification for pricing under the Standard PPA is sought.

Definition of Shared Interconnection and Infrastructure

QFs otherwise meeting the above-described separate ownership test and thereby qualified for entitlement to pricing under the Standard PPA will not be disqualified by utilizing an interconnection or other infrastructure not providing motive force or fuel that is shared with other QFs qualifying for pricing under the Standard PPA so long as the use of the shared interconnection complies with the interconnecting utility’s safety and reliability standards, interconnection agreement requirements and Prudent Electrical Practices as that term is defined in the interconnecting utility’s approved Standard PPA.

OTHER DEFINITIONS**Mid-C Index Price**

As used in this schedule, the daily Mid-C Index Price shall be the Day Ahead Intercontinental Exchange (“ICE”) for the bilateral OTC market for energy at the Mid-C Physical for Average

SCHEDULE 201 (Continued)

OTHER DEFINITIONS (Continued)

On-Peak Power and Average Off-Peak Power found on the following website: <https://www.theice.com/products/OTC/Physical-Energy/Electricity>. In the event ICE no longer publishes this index, PGE and the Seller agree to select an alternative successor index representative of the Mid-C trading hub.

Definition of RPS Attributes

As used in this schedule, RPS Attributes means all attributes related to the Net Output generated by the Facility that are required in order to provide PGE with “qualifying electricity,” as that term is defined in Oregon’s Renewable Portfolio Standard Act, Ore. Rev. Stat. 469A.010, in effect at the time of execution of this Agreement. RPS Attributes do not include Environmental Attributes that are greenhouse gas offsets from methane capture not associated with the generation of electricity and not needed to ensure that there are zero net emissions associated with the generation of electricity.

Definition of Environmental Attributes

As used in this schedule, Environmental Attributes shall mean any and all claims, credits, benefits, emissions reductions, offsets, and allowances, howsoever entitled, resulting from the avoidance of the emission of any gas, chemical, or other substance to the air, soil or water. Environmental Attributes include but are not limited to: (1) any avoided emissions of pollutants to the air, soil, or water such as (subject to the foregoing) sulfur oxides (SO_x), nitrogen oxides (NO_x), carbon monoxide (CO), and other pollutants; and (2) any avoided emissions of carbon dioxide (CO₂), methane (CH₄), and other greenhouse gases (GHGs) that have been determined by the United Nations Intergovernmental Panel on Climate Change to contribute to the actual or potential threat of altering the Earth’s climate by trapping heat in the atmosphere.

Definition of Resource Sufficiency Period

This is the period from the current year through 2020.

Definition of Resource Deficiency Period

This is the period from 2021 through 2034.

Definition of Renewable Resource Sufficiency Period

This is the period from the current year through 2019.

Definition of Renewable Resource Deficiency Period

This is the period from 2020 through 2034.

SCHEDULE 201 (Concluded)**DISPUTE RESOLUTION**

Upon request, the QF will provide the purchasing utility with documentation verifying the ownership, management and financial structure of the QF in reasonably sufficient detail to allow the utility to make an initial determination of whether or not the QF meets the above-described criteria for entitlement to pricing under the Standard PPA.

The QF may present disputes to the Commission for resolution using the following process:

The QF may file a complaint asking the Commission to adjudicate disputes regarding the formation of the standard contract. The QF may not file such a complaint during any 15-day period in which the utility has the obligation to respond, but must wait until the 15-day period has passed.

The utility may respond to the complaint within ten days of service.

The Commission will limit its review to the issues identified in the complaint and response, and utilize a process similar to the arbitration process adopted to facilitate the execution of interconnection agreements among telecommunications carriers. See OAR 860, Division 016. The administrative law judge will not act as an arbitrator.

SPECIAL CONDITIONS

1. Delivery of energy by Seller will be at a voltage, phase, frequency, and power factor as specified by the Company.
2. If the Seller also receives retail Electricity Service from the Company at the same location, any payments under this schedule will be credited to the Seller's retail Electricity Service bill. At the option of the Customer, any net credit over \$10.00 will be paid by check to the Customer.
3. Unless required by state or federal law, if the 1978 Public Utility Regulatory Policies Act (PURPA) is repealed, PPAs entered into pursuant to this schedule will not terminate prior to the Standard or Negotiated PPA's termination date.

TERM OF AGREEMENT

Not less than one year and not to exceed 20 years.