

**STANDARD RENEWABLE IN-SYSTEM VARIABLE POWER PURCHASE
AGREEMENT**

THIS AGREEMENT, entered into this 21st day, 6/2016
20____, is between Rafael Solar, LLC ("Seller") and Portland General Electric Company
("PGE") (hereinafter each a "Party" or collectively, "Parties").

RECITALS

Seller intends to construct, own, operate and maintain a solar photovoltaic facility
for the generation of electric power located in Marion County, at approximately
44°51'35"N 123°0'30"W with a Nameplate Capacity Rating of 2,200 kilowatt ("kW"), as
further described in Exhibit A ("Facility"); and

Seller intends to operate the Facility as a "Qualifying Facility," as such term is
defined in Section 3.1.3, below.

Seller shall sell and PGE shall purchase the entire Net Output, as such term is
defined in Section 1.21, below, from the Facility in accordance with the terms and
conditions of this Agreement.

AGREEMENT

NOW, THEREFORE, the Parties mutually agree as follows:

SECTION 1: DEFINITIONS

When used in this Agreement, the following terms shall have the following
meanings:

1.1. "As-built Supplement" means the supplement to Exhibit A provided by
Seller in accordance with Section 4.3 following completion of construction of the
Facility, describing the Facility as actually built.

1.2. "Base Hours" is defined as the total number of hours in each Contract
Year (8,760 or 8,784 for leap year).

1.3. "Billing Period" means a period between PGE's readings of its power
purchase billing meter at the Facility in the normal course of PGE's business. Such
periods may vary and may not coincide with calendar months; however, PGE shall use
best efforts to read the power purchase billing meter in 12 equally spaced periods per
year.

1.4. "Cash Escrow" means an agreement by two parties to place money into the custody of a third party for delivery to a grantee only after the fulfillment of the conditions specified.

1.5. "Commercial Operation Date" means the date that the Facility is deemed by PGE to be fully operational and reliable. PGE may, at its discretion, require, among other things, that all of the following events have occurred:

1.5.1. (facilities with nameplate under 500 kW exempt from following requirement) PGE has received a certificate addressed to PGE from a Licensed Professional Engineer ("LPE") acceptable to PGE in its reasonable judgment stating that the Facility is able to generate electric power reliably in accordance with the terms and conditions of this Agreement (certifications required under this Section 1.5 can be provided by one or more LPEs);

1.5.2. Start-Up Testing of the Facility has been completed in accordance with Section 1.36;

1.5.3. (facilities with nameplate under 500 kW exempt from following requirement) After PGE has received notice of completion of Start-Up Testing, PGE has received a certificate addressed to PGE from an LPE stating that the Facility has operated for testing purposes under this Agreement and was continuously mechanically available for operation for a minimum of 120 hours. The Facility must provide ten (10) working days written notice to PGE prior to the start of the initial testing period. If the mechanical availability of the Facility is interrupted during this initial testing period or any subsequent testing period, the Facility shall promptly start a new Test Period and provide PGE forty-eight (48) hours written notice prior to the start of such testing period;

1.5.4. (facilities with nameplate under 500 kW exempt from following requirement) PGE has received a certificate addressed to PGE from an LPE stating that in accordance with the Generation Interconnection Agreement, all required interconnection facilities have been constructed all required interconnection tests have been completed; and the Facility is physically interconnected with PGE's electric system.

1.5.5. (facilities with nameplate under 500kW exempt from following requirement) PGE has received a certificate addressed to PGE from an LPE stating that Seller has obtained all Required Facility Documents and, if requested by PGE in writing, has provided copies of any or all such requested Required Facility Documents;

1.6. "Contract Price" means the applicable price, including on-peak and off-peak prices, as specified in the Schedule.

1.7. "Contract Year" means each twelve (12) month period commencing upon the Commercial Operation Date or its anniversary during the Term, except the final contract year will be the period from the last anniversary of the Commercial Operation Date during the Term until the end of the Term.

1.8. "Effective Date" has the meaning set forth in Section 2.1.

1.9. "Environmental Attributes" shall mean any and all claims, credits, benefits, emissions reductions, offsets, and allowances, howsoever entitled, resulting from the avoidance of the emission of any gas, chemical or other substance to the air, soil or water. Environmental Attributes include but are not limited to: (1) any avoided emissions of pollutants to the air, soil or water such as (subject to the foregoing) sulfur oxides (SO_x), nitrogen oxides (NO_x), carbon monoxide (CO), and other pollutants; and (2) any avoided emissions of carbon dioxide (CO₂), methane (CH₄), and other greenhouse gasses (GHGs) that have been determined by the United Nations Intergovernmental Panel on Climate Change to contribute to the actual or potential threat of altering the Earth's climate by trapping heat in the atmosphere.

1.10. "Facility" has the meaning set forth in the Recitals.

1.11. "Generation Interconnection Agreement" means the generation interconnection agreement to be entered into separately between Seller and PGE, providing for the construction, operation, and maintenance of interconnection facilities required to accommodate deliveries of Seller's Net Output.

1.12. "Generation Unit" means each separate electrical generator that contributes towards Nameplate Capacity Rating included in Exhibit A. For solar facilities, a generating unit is a complete solar electrical generation system within the Facility that is able to generate and deliver energy to the Point of Delivery independent of other Generation Units within the same Facility.

1.13. "Letter of Credit" means an engagement by a bank or other person made at the request of a customer that the issuer will honor drafts or other demands for payment upon compliance with the conditions specified in the letter of credit.

1.14. "Licensed Professional Engineer" or "LPE" means a person who is licensed to practice engineering in the state where the Facility is located, who has no economic relationship, association, or nexus with the Seller, and who is not a representative of a consulting engineer, contractor, designer or other individual involved in the development of the Facility, or of a manufacturer or supplier of any equipment installed in the Facility. Such Licensed Professional Engineer shall be licensed in an appropriate engineering discipline for the required certification being made and be acceptable to PGE in its reasonable judgment.

1.15. "Lost Energy" means ((the Guarantee of Mechanical Availability as set forth in 3.1.10 / MAP) X Net Output for a Calendar Year) – Net Output for the Calendar Year. Lost Energy shall be zero unless the result of the calculation in this subsection results in a positive number.

1.16. "Lost Energy Value" means Lost Energy X the excess of the annual time-weighted average Mid-C Index Price for On-Peak and Off-Peak Hours over the time-weighted average Contract Price for On-Peak and Off-Peak Hours for the

corresponding time period (provided that such excess shall not exceed the Contract Price and further provided that Lost Energy is deemed to be zero prior to reaching the Commercial Operation Date) plus any reasonable costs incurred by PGE to purchase replacement power and/or transmission to deliver the replacement power to the Point of Delivery. (For Start-Up Lost Energy Value see Section 1.35).

1.17. "Mechanical Availability Percentage" or "MAP" shall mean that percentage for any Contract Year for the Facility calculated in accordance with the following formula:

$$\text{MAP} = 100 \times (\text{Operational Hours}) / (\text{Base Hours} \times \text{Number of Units})$$

1.18. "Mid-C Index Price" means the Day Ahead Intercontinental Exchange ("ICE") index price for the bilateral OTC market for energy at the Mid-C Physical for Average On Peak Power and Average Off Peak Power found on the following website: <https://www.theice.com/products/OTC/Physical-Energy/Electricity>. In the event ICE no longer publishes this index, PGE and the Seller agree to select an alternative successor index representative of the Mid-C trading hub.

1.19. "Nameplate Capacity Rating" means the maximum capacity of the Facility as stated by the manufacturer, expressed in kW, which shall not exceed 10,000 kW.

1.20. "Net Dependable Capacity" means the maximum capacity the Facility can sustain over a specified period modified for seasonal limitations, if any, and reduced by the capacity required for station service or auxiliaries.

1.21. "Net Output" means all energy expressed in kWhs produced by the Facility, less station and other onsite use and less transformation and transmission losses. Net Output does not include any environmental attributes.

1.22. "Number of Units" means the number of Generating Units in the Facility described in Exhibit A.

1.23. "Off-Peak Hours" has the meaning provided in the Schedule.

1.24. "On-Peak Hours" has the meaning provided in the Schedule.

1.25. "Operational Hours" for the Facility means the total across all Generating Units of the number of hours each of the Facility's Generating Units are potentially capable of producing power at its Nameplate Capacity Rating regardless of actual weather, season and time of day or night, without any mechanical operating constraint or restriction, and potentially capable of delivering such power to the Point of Delivery in a Contract Year. During up to, but not more than, 200 hours of Planned Maintenance during a Contract Year for each Generation Unit and hours during which an event of Force Majeure exists, a Generation Unit shall be considered potentially capable of delivering such power to the Point of Delivery. For example, in the absence of any Planned Maintenance beyond 200 hours on any Generation Unit of Event of Force

Majeure, the Operational Hours for a wind farm with five separate two MW turbines would be 43,800 for a Contract Year.

1.26. "Planned Maintenance" means outages scheduled 90 days in advance, with PGE's prior written consent, which shall not be unreasonably withheld.

1.27. "Point of Delivery" means the high side of the generation step up transformer(s) located at the point of interconnection between the Facility and PGE's distribution or transmission system, as specified in the Generation Interconnection Agreement.

1.28. "Pre-Commercial Operation Date Minimum Net Output" shall mean, unless such MWh is specifically set forth by Seller in Exhibit A, an amount in MWh equal to seventy-five percent (75%) of the Nameplate Capacity Rating X thirty percent (30%) for a wind or other renewable QF or fifty percent (50%) for a solar QF X (whole months since the date selected in Section 2.2.1 / 12) X (8760 hours – 200 hours (assumed Planned Maintenance)) for each month. If Seller has provided specific expected monthly Net Output amounts for the Facility in Exhibit A, "Pre-Commercial Operation Date Minimum Net Output" shall mean seventy-five (75%) X expected Net Output set forth in Exhibit A for each month.

1.29. "Prime Rate" means the publicly announced prime rate or reference rate for commercial loans to large businesses with the highest credit rating in the United States in effect from time to time quoted by Citibank, N.A. If a Citibank, N.A. prime rate is not available, the applicable Prime Rate shall be the announced prime rate or reference rate for commercial loans in effect from time to time quoted by a bank with \$10 billion or more in assets in New York City, N.Y., selected by the Party to whom interest based on the prime rate is being paid.

1.30. "Prudent Electrical Practices" means those practices, methods, standards and acts engaged in or approved by a significant portion of the electric power industry in the Western Electricity Coordinating Council that at the relevant time period, in the exercise of reasonable judgment in light of the facts known or that should reasonably have been known at the time a decision was made, would have been expected to accomplish the desired result in a manner consistent with good business practices, reliability, economy, safety and expedition, and which practices, methods, standards and acts reflect due regard for operation and maintenance standards recommended by applicable equipment suppliers and manufacturers, operational limits, and all applicable laws and regulations. Prudent Electrical Practices are not intended to be limited to the optimum practice, method, standard or act to the exclusion of all others, but rather to those practices, methods and acts generally acceptable or approved by a significant portion of the electric power generation industry in the relevant region, during the relevant period, as described in the immediate preceding sentence.

1.31. "Required Facility Documents" means all licenses, permits, authorizations, and agreements necessary for construction, operation, interconnection, and maintenance of the Facility including without limitation those set forth in Exhibit B.

1.32. "RPS Attributes" means all attributes related to the Net Output generated by the Facility that are required in order to provide PGE with "qualifying electricity," as that term is defined in Oregon's Renewable Portfolio Standard Act, Ore. Rev. Stat. 469A.010, in effect at the time of execution of this Agreement. RPS Attributes do not include Environmental Attributes that are greenhouse gas offsets from methane capture not associated with the generation of electricity and not needed to ensure that there are zero net emissions associated with the generation of electricity.

1.33. "Schedule" shall mean PGE Schedule 201 filed with the Oregon Public Utilities Commission ("Commission") in effect on the Effective Date of this Agreement and attached hereto as Exhibit D, the terms of which are hereby incorporated by reference.

1.34. "Senior Lien" means a prior lien which has precedence as to the property under the lien over another lien or encumbrance.

1.35. "Start-Up Lost Energy Value" means for the period after the date specified in Section 2.2.2 but prior to achievement of the Commercial Operation Date: zero, unless the Net Output is less than the pro-rated Pre-Commercial Operation Date Minimum Net Output for the applicable delay period, and the time-weighted average of the delay period's Mid-C Index Price for On-Peak Hours and Off-Peak Hours is greater than the time-weighted average of the delay period's Contract Price for On-Peak Hours and Off-Peak Hours, in which case Startup Lost Energy Value equals: (pro-rated Pre-Commercial Operation Date Minimum Net Output for the applicable period - Net Output for the applicable period) X (the lower of: the time-weighted average of the Contract Price for On-Peak hours and Off-Peak Hours during the applicable period; or (the time-weighted average of the Mid-C Index Price for On-Peak Hours and Off-Peak Hours during the applicable period - the time-weighted average of the Contract Price for On-Peak Hours and Off-Peak Hours during the applicable period)). The time-weighted average in this section will reflect the relative proportions of On-Peak Hours and Off-Peak Hours in each day.

1.36. "Start-Up Testing" means the completion of applicable required factory and start-up tests as set forth in Exhibit C.

1.37. "Step-in Rights" means the right of one party to assume an intervening position to satisfy all terms of an agreement in the event the other party fails to perform its obligations under the agreement.

1.38. "Term" shall mean the period beginning on the Effective Date and ending on the Termination Date.

1.39. "Test Period" shall mean a period of sixty (60) days or a commercially reasonable period determined by the Seller.

References to Recitals, Sections, and Exhibits are to be the recitals, sections and exhibits of this Agreement.

SECTION 2: TERM; COMMERCIAL OPERATION DATE

2.1. This Agreement shall become effective upon execution by both Parties ("Effective Date").

2.2. Time is of the essence of this Agreement, and Seller's ability to meet certain requirements prior to the Commercial Operation Date and to complete all requirements to establish the Commercial Operation Date is critically important. Therefore,

2.2.1 By September 30, 2017 Seller shall begin initial deliveries of Net Output; and

2.2.2 By October 31, 2017 Seller shall have completed all requirements under Section 1.5 and shall have established the Commercial Operation Date.

2.2.3 Unless the Parties agree in writing that a later Commercial Operation Date is reasonable and necessary, the Commercial Operation Date shall be no more than three (3) years from the Effective Date. PGE will not unreasonably withhold agreement to a Commercial Operation Date that is more than three (3) years from the Effective date if the Seller has demonstrated that a later Commercial Operation Date is reasonable and necessary.

2.3. This Agreement shall terminate on the twentieth (20th) anniversary of the Effective Date, or the date the Agreement is terminated in accordance with Section 9 or 11, whichever is earlier ("Termination Date").

SECTION 3: REPRESENTATIONS AND WARRANTIES

3.1. Seller and PGE represent, covenant, and warrant as follows:

3.1.1. Seller warrants it is a limited liability company duly organized under the laws of Oregon.

3.1.2. Seller warrants that the execution and delivery of this Agreement does not contravene any provision of, or constitute a default under, any indenture, mortgage, or other material agreement binding on Seller or any valid order of any court, or any regulatory agency or other body having authority to which Seller is subject.

3.1.3. Seller warrants that the Facility is and shall for the Term of this Agreement continue to be a "Qualifying Facility" ("QF") as that term is defined in the version of 18 C.F.R. Part 292 in effect on the Effective Date. Seller has provided the appropriate QF certification, which may include a Federal Energy Regulatory Commission ("FERC") self-certification to PGE prior to PGE's execution of this Agreement. At any time during the Term of this Agreement, PGE may require Seller to provide PGE with evidence satisfactory to PGE in its reasonable discretion that the Facility continues to qualify as a QF under all applicable requirements.

3.1.4. Seller warrants that it has not within the past two (2) years been the debtor in any bankruptcy proceeding, and Seller is and will continue to be for the Term of this Agreement current on all of its financial obligations.

3.1.5. Seller warrants that during the Term of this Agreement, all of Seller's right, title and interest in and to the Facility shall be free and clear of all liens and encumbrances other than liens and encumbrances arising from third-party financing of the Facility other than workers', mechanics', suppliers' or similar liens, or tax liens, in each case arising in the ordinary course of business that are either not yet due and payable or that have been released by means of a performance bond acceptable to PGE posted within eight (8) calendar days of the commencement of any proceeding to foreclose the lien.

3.1.6. Seller warrants that it will design and operate the Facility consistent with Prudent Electrical Practices.

3.1.7. Seller warrants that the Facility has a Nameplate Capacity Rating not greater than 10,000 kW.

3.1.8. Seller warrants that Net Dependable Capacity of the Facility is 2,200 kW.

3.1.9. Seller estimates that the average annual Net Output to be delivered by the Facility to PGE is 2,177,786 kilowatt-hours ("kWh"), which amount PGE will include in its resource planning.

3.1.10. Seller represents and warrants that the Facility shall achieve the following Mechanical Availability Percentages ("Guarantee of Mechanical Availability"):

3.1.10.1 Ninety percent (90%) beginning in the first Contract Year and extending through the Term for the Facility, if the Facility was operational and sold electricity to PGE or another buyer prior to the Effective Date of this Agreement; or

3.1.10.2 Ninety percent (90%) beginning in Contract Year three and extending throughout the remainder of the Term.

3.1.10.3 Annually, within 90 days of the end of each Contract Year Seller shall send to PGE a detailed written report demonstrating and providing evidence of the actual MAP for the previous Contract Year.

3.1.10.4 Seller's failure to meet the Guarantee of Mechanical Availability in a Calendar Year shall result in damages payable to PGE by Seller equal to the Lost Energy Value. PGE shall bill Seller for such damages in accordance with Section 8.

3.1.11. Seller will deliver from the Facility to PGE at the Point of Delivery Net Output not to exceed a maximum of 5,203,440 kWh of Net Output during each Contract Year ("Maximum Net Output").

3.1.12. By the Commercial Operation Date, Seller has entered into a Generation Interconnection Agreement for a term not less than the term of this Agreement.

3.1.13. PGE warrants that it has not within the past two (2) years been the debtor in any bankruptcy proceeding, and PGE is and will continue to be for the Term of this Agreement current on all of its financial obligations.

3.1.14. Seller warrants that (i) the Facility satisfies the eligibility requirements specified in the Definition of a Small Cogeneration Facility or Small Power Production Facility Eligible to Receive the Standard Renewable Rates and Standard Renewable PPA in PGE's Schedule and (ii) Seller will not make any changes in its ownership, control or management during the term of this Agreement that would cause it to not be in compliance with the Definition of a Small Cogeneration Facility or Small Power Production Facility Eligible to Receive the Standard Renewable Rates and Standard Renewable PPA in PGE's Schedule. Seller will provide, upon request by PGE not more frequently than every 36 months, such documentation and information as may be reasonably required to establish Seller's continued compliance with such Definition. PGE agrees to take reasonable steps to maintain the confidentiality of any portion of the above described documentation and information that the Seller identifies as confidential except PGE will provide all such confidential information to the Public Utility Commission of Oregon upon the Commission's request.

3.1.15. Seller warrants that it will comply with all requirements necessary for all Transferred RECs (as defined in Section 4.5) associated with Net Output to be issued, monitored, accounted for, and transferred by and through the Western Renewable Energy Generation System consistent with the provisions of OAR 330-160-0005 through OAR 330-160-0050. PGE warrants that it will reasonably cooperate in Seller's efforts to meet such requirements, including, for example serving as the qualified reporting entity for the Facility if the Facility is located in PGE's balancing authority.

SECTION 4: DELIVERY OF POWER, PRICE AND ENVIRONMENTAL ATTRIBUTES

4.1. Commencing on the Effective Date and continuing through the Term of this Agreement, Seller shall sell to PGE the entire Net Output delivered from the Facility at the Point of Delivery.

4.2. PGE shall pay Seller the Contract Price for all delivered Net Output.

4.3. Upon completion of construction of the Facility, Seller shall provide PGE an As-built Supplement to specify the actual Facility as built. Seller shall not increase the Nameplate Capacity Rating above that specified in Exhibit A or increase the ability of the Facility to deliver Net Output in quantities in excess of the Net Dependable Capacity, or the Maximum Net Output as described in Section 3.1.11 above, through any means including, but not limited to, replacement, modification, or addition of existing equipment, except with prior written notice to PGE. In the event Seller increases the Nameplate Capacity Rating of the Facility to no more than 10,000 kW

pursuant to this section, PGE shall pay the Contract Price for the additional delivered Net Output. In the event Seller increases the Nameplate Capacity Rating to greater than 10,000 kW, then Seller shall be required to enter into a new power purchase agreement for all delivered Net Output proportionally related to the increase of Nameplate Capacity above 10,000 kW.

4.4. To the extent not otherwise provided in the Generation Interconnection Agreement, all costs associated with the modifications to PGE's interconnection facilities or electric system occasioned by or related to the interconnection of the Facility with PGE's system, or any increase in generating capability of the Facility, or any increase of delivery of Net Dependable Capacity from the Facility, shall be borne by Seller.

4.5. During the Renewable Resource Deficiency Period, Seller shall provide and PGE shall acquire the RPS Attributes for the Contract Years as specified in the Schedule and Seller shall retain ownership of all other Environmental Attributes (if any). During the Renewable Resource Sufficiency Period, and any period within the Term of this Agreement after completion of the first fifteen (15) years after the Commercial Operation Date, Seller shall retain all Environmental Attributes in accordance with the Schedule. The Contract Price includes full payment for the Net Output and any RPS Attributes transferred to PGE under this Agreement. With respect to Environmental Attributes not transferred to PGE under this Agreement ("Seller-Retained Environmental Attributes") Seller may report under §1605(b) of the Energy Policy Act of 1992 or under any applicable program as belonging to Seller any of the Seller-Retained Environmental Attributes, and PGE shall not report under such program that such Seller-Retained Environmental Attributes belong to it. With respect to RPS Attributes transferred to PGE under this Agreement ("Transferred RECs"), PGE may report under §1605(b) of the Energy Policy Act of 1992 or under any applicable program as belonging to it any of the Transferred RECs, and Seller shall not report under such program that such Transferred RECs belong to it.

SECTION 5: OPERATION AND CONTROL

5.1. Seller shall operate and maintain the Facility in a safe manner in accordance with the Generation Interconnection Agreement, and Prudent Electrical Practices. PGE shall have no obligation to purchase Net Output from the Facility to the extent the interconnection of the Facility to PGE's electric system is disconnected, suspended or interrupted, in whole or in part, pursuant to the Generation Interconnection Agreement, or to the extent generation curtailment is required as a result of Seller's noncompliance with the Generation Interconnection Agreement. Seller is solely responsible for the operation and maintenance of the Facility. PGE shall not, by reason of its decision to inspect or not to inspect the Facility, or by any action or inaction taken with respect to any such inspection, assume or be held responsible for any liability or occurrence arising from the operation and maintenance by Seller of the Facility.

5.2. Seller agrees to provide sixty (60) days advance written notice of any scheduled maintenance that would require shut down of the Facility for any period of time.

5.3. If the Facility ceases operation for unscheduled maintenance, Seller immediately shall notify PGE of the necessity of such unscheduled maintenance, the time when such maintenance has occurred or will occur, and the anticipated duration of such maintenance. Seller shall take all reasonable measures and exercise its best efforts to avoid unscheduled maintenance, to limit the duration of such unscheduled maintenance, and to perform unscheduled maintenance during Off-Peak hours.

SECTION 6: CREDITWORTHINESS

In the event Seller: a) is unable to represent or warrant as required by Section 3 that it has not been a debtor in any bankruptcy proceeding within the past two (2) years; b) becomes such a debtor during the Term; or c) is not or will not be current on all its financial obligations, Seller shall immediately notify PGE and shall promptly (and in no less than 10 days after notifying PGE) provide default security in an amount reasonably acceptable to PGE in one of the following forms: Senior Lien, Step-in Rights, a Cash Escrow or Letter of Credit. The amount of such default security that shall be acceptable to PGE shall be equal to: (annual On Peak Hours) X (On Peak Price – Off Peak Price) X (Net Dependable Capacity). Notwithstanding the foregoing, in the event Seller is not current on construction related financial obligations, Seller shall notify PGE of such delinquency and PGE may, in its discretion, grant an exception to the requirements to provide default security if the QF has negotiated financial arrangements with the construction loan lender that mitigate Seller's financial risk to PGE.

SECTION 7: METERING

7.1. PGE shall design, furnish, install, own, inspect, test, maintain and replace all metering equipment at Seller's cost and as required pursuant to the Generation Interconnection Agreement.

7.2. Metering shall be performed at the location and in a manner consistent with this Agreement and as specified in the Generation Interconnection Agreement. All Net Output purchased hereunder shall be adjusted to account for electrical losses, if any, between the point of metering and the Point of Delivery, so that the purchased amount reflects the net amount of power flowing into PGE's system at the Point of Delivery.

7.3. PGE shall periodically inspect, test, repair and replace the metering equipment as provided in the Generation Interconnection Agreement. If any of the inspections or tests discloses an error exceeding two (2%) percent of the actual energy delivery, either fast or slow, proper correction, based upon the inaccuracy found, shall be made of previous readings for the actual period during which the metering equipment rendered inaccurate measurements if that period can be ascertained. If the

actual period cannot be ascertained, the proper correction shall be made to the measurements taken during the time the metering equipment was in service since last tested, but not exceeding three (3) months, in the amount the metering equipment shall have been shown to be in error by such test. Any correction in billings or payments resulting from a correction in the meter records shall be made in the next monthly billing or payment rendered. Such correction, when made, shall constitute full adjustment of any claim between Seller and PGE arising out of such inaccuracy of metering equipment.

7.4. To the extent not otherwise provided in the Generation Interconnection Agreement, all of PGE's costs relating to all metering equipment installed to accommodate Seller's Facility shall be borne by Seller.

SECTION 8: BILLINGS, COMPUTATIONS AND PAYMENTS

8.1. On or before the thirtieth (30th) day following the end of each Billing Period, PGE shall send to Seller payment for Seller's deliveries of Net Output to PGE, together with computations supporting such payment. PGE may offset any such payment to reflect amounts owing from Seller to PGE pursuant to this Agreement, the Generation Interconnection Agreement, and any other agreement related to the Facility between the Parties or otherwise. On or before the thirtieth (30th) day following the end of each Contract Year, PGE shall bill for any Lost Energy Value accrued pursuant to this Agreement.

8.2. Any amounts owing after the due date thereof shall bear interest at the Prime Rate plus two percent (2%) from the date due until paid; provided, however, that the interest rate shall at no time exceed the maximum rate allowed by applicable law.

SECTION 9: DEFAULT, REMEDIES AND TERMINATION

9.1. In addition to any other event that may constitute a default under this Agreement, the following events shall constitute defaults under this Agreement:

9.1.1. Breach by Seller or PGE of a representation or warranty, except for Section 3.1.4, set forth in this Agreement.

9.1.2. Seller's failure to provide default security, if required by Section 6, prior to delivery of any Net Output to PGE or within 10 days of notice.

9.1.3. Seller's failure to meet the Guarantee of Mechanical Availability established in Section 3.1.10 for two consecutive Contract Years or Seller's failure to provide any written report required by that section.

9.1.4. If Seller is no longer a Qualifying Facility.

9.1.5. Failure of PGE to make any required payment pursuant to Section 8.1.

9.1.6. Seller's failure to meet the Commercial Operation Date.

9.2. In the event of a default under Section 9.1.6, PGE may provide Seller with written notice of default. Seller shall have one year in which to cure the default during which time the Seller shall pay PGE damages equal to the Lost Energy Value. If Seller is unable to cure the default, PGE may immediately terminate this Agreement as provided in Section 9.3. PGE's resource sufficiency/deficiency position shall have no bearing on PGE's right to terminate the Agreement under this Section 9.2.

9.3. In the event of a default under this Agreement, except as otherwise provided in this Agreement, the non-defaulting party may immediately terminate this Agreement at its sole discretion by delivering written notice to the other Party. In addition, the non-defaulting party may pursue any and all legal or equitable remedies provided by law or pursuant to this Agreement including damages related to the need to procure replacement power. A termination hereunder shall be effective upon the date of delivery of notice, as provided in Section 20. The rights provided in this Section 9 are cumulative such that the exercise of one or more rights shall not constitute a waiver of any other rights.

9.4. If this Agreement is terminated as provided in this Section 9 PGE shall make all payments, within thirty (30) days, that, pursuant to the terms of this Agreement, are owed to Seller as of the time of receipt of notice of default. PGE shall not be required to pay Seller for any Net Output delivered by Seller after such notice of default.

9.5. In the event PGE terminates this Agreement pursuant to this Section 9, and Seller wishes to again sell Net Output to PGE following such termination, PGE in its sole discretion may require that Seller shall do so subject to the terms of this Agreement, including but not limited to the Contract Price until the Term of this Agreement (as set forth in Section 2.3) would have run in due course had the Agreement remained in effect. At such time Seller and PGE agree to execute a written document ratifying the terms of this Agreement.

9.6. Sections 9.1, 9.4, 9.5, 10, and 19.2 shall survive termination of this Agreement.

SECTION 10: INDEMNIFICATION AND LIABILITY

10.1. Seller agrees to defend, indemnify and hold harmless PGE, its directors, officers, agents, and representatives against and from any and all loss, claims, actions or suits, including costs and attorney's fees, both at trial and on appeal, resulting from, or arising out of or in any way connected with Seller's delivery of electric power to PGE or with the facilities at or prior to the Point of Delivery, or otherwise arising out of this Agreement, including without limitation any loss, claim, action or suit, for or on account of injury, bodily or otherwise, to, or death of, persons, or for damage to, or destruction or economic loss of property belonging to PGE, Seller or others, excepting to the extent such loss, claim, action or suit may be caused by the negligence of PGE, its directors, officers, employees, agents or representatives.

10.2. PGE agrees to defend, indemnify and hold harmless Seller, its directors, officers, agents, and representatives against and from any and all loss, claims, actions or suits, including costs and attorney's fees, both at trial and on appeal, resulting from, or arising out of or in any way connected with PGE's receipt of electric power from Seller or with the facilities at or after the Point of Delivery, or otherwise arising out of this Agreement, including without limitation any loss, claim, action or suit, for or on account of injury, bodily or otherwise, to, or death of, persons, or for damage to, or destruction or economic loss of property belonging to PGE, Seller or others, excepting to the extent such loss, claim, action or suit may be caused by the negligence of Seller, its directors, officers, employees, agents or representatives.

10.3. Nothing in this Agreement shall be construed to create any duty to, any standard of care with reference to, or any liability to any person not a Party to this Agreement. No undertaking by one Party to the other under any provision of this Agreement shall constitute the dedication of that Party's system or any portion thereof to the other Party or to the public, nor affect the status of PGE as an independent public utility corporation or Seller as an independent individual or entity.

10.4. NEITHER PARTY SHALL BE LIABLE TO THE OTHER FOR SPECIAL, PUNITIVE, INDIRECT OR CONSEQUENTIAL DAMAGES, WHETHER ARISING FROM CONTRACT, TORT (INCLUDING NEGLIGENCE), STRICT LIABILITY OR OTHERWISE.

SECTION 11: INSURANCE

11.1. Prior to the connection of the Facility to PGE's electric system, provided such Facility has a design capacity of 200 kW or more, Seller shall secure and continuously carry for the Term hereof, with an insurance company or companies rated not lower than "B+" by the A. M. Best Company, insurance policies for bodily injury and property damage liability. Such insurance shall include provisions or endorsements naming PGE, its directors, officers and employees as additional insureds; provisions that such insurance is primary insurance with respect to the interest of PGE and that any insurance or self-insurance maintained by PGE is excess and not contributory insurance with the insurance required hereunder; a cross-liability or severability of insurance interest clause; and provisions that such policies shall not be canceled or their limits of liability reduced without thirty (30) days' prior written notice to PGE. Initial limits of liability for all requirements under this section shall be \$1,000,000 million single limit, which limits may be required to be increased or decreased by PGE as PGE determines in its reasonable judgment economic conditions or claims experience may warrant.

11.2. Prior to the connection of the Facility to PGE's electric system, provided such facility has a design capacity of 200 kW or more, Seller shall secure and continuously carry for the Term hereof, in an insurance company or companies rated not lower than "B+" by the A. M. Best Company, insurance acceptable to PGE against property damage or destruction in an amount not less than the cost of replacement of the Facility. Seller promptly shall notify PGE of any loss or damage to the Facility.

Unless the Parties agree otherwise, Seller shall repair or replace the damaged or destroyed Facility, or if the facility is destroyed or substantially destroyed, it may terminate this Agreement. Such termination shall be effective upon receipt by PGE of written notice from Seller. Seller shall waive its insurers' rights of subrogation against PGE regarding Facility property losses.

11.3. Prior to the connection of the Facility to PGE's electric system and at all other times such insurance policies are renewed or changed, Seller shall provide PGE with a copy of each insurance policy required under this Section, certified as a true copy by an authorized representative of the issuing insurance company or, at the discretion of PGE, in lieu thereof, a certificate in a form satisfactory to PGE certifying the issuance of such insurance. If Seller fails to provide PGE with copies of such currently effective insurance policies or certificates of insurance, PGE at its sole discretion and without limitation of other remedies, may upon ten (10) days advance written notice by certified or registered mail to Seller either withhold payments due Seller until PGE has received such documents, or purchase the satisfactory insurance and offset the cost of obtaining such insurance from subsequent power purchase payments under this Agreement.

SECTION 12: FORCE MAJEURE

12.1. As used in this Agreement, "Force Majeure" or "an event of Force Majeure" means any cause beyond the reasonable control of the Seller or of PGE which, despite the exercise of due diligence, such Party is unable to prevent or overcome. By way of example, Force Majeure may include but is not limited to acts of God, fire, flood, storms, wars, hostilities, civil strife, strikes, and other labor disturbances, earthquakes, fires, lightning, epidemics, sabotage, restraint by court order or other delay or failure in the performance as a result of any action or inaction on behalf of a public authority which by the exercise of reasonable foresight such Party could not reasonably have been expected to avoid and by the exercise of due diligence, it shall be unable to overcome, subject, in each case, to the requirements of the first sentence of this paragraph. Force Majeure, however, specifically excludes the cost or availability of resources to operate the Facility, changes in market conditions that affect the price of energy or transmission, wind or water droughts, and obligations for the payment of money when due.

12.2. If either Party is rendered wholly or in part unable to perform its obligation under this Agreement because of an event of Force Majeure, that Party shall be excused from whatever performance is affected by the event of Force Majeure to the extent and for the duration of the Force Majeure, after which such Party shall recommence performance of such obligation, provided that:

12.2.1. the non-performing Party shall, promptly, but in any case within one (1) week after the occurrence of the Force Majeure, give the other Party written notice describing the particulars of the occurrence; and

12.2.2. the suspension of performance shall be of no greater scope and of no longer duration than is required by the Force Majeure; and

12.2.3. the non-performing Party uses its best efforts to remedy its inability to perform its obligations under this Agreement.

12.3. No obligations of either Party which arose before the Force Majeure causing the suspension of performance shall be excused as a result of the Force Majeure.

12.4. Neither Party shall be required to settle any strike, walkout, lockout or other labor dispute on terms which, in the sole judgment of the Party involved in the dispute, are contrary to the Party's best interests.

SECTION 13: SEVERAL OBLIGATIONS

Nothing contained in this Agreement shall ever be construed to create an association, trust, partnership or joint venture or to impose a trust or partnership duty, obligation or liability between the Parties. If Seller includes two or more parties, each such party shall be jointly and severally liable for Seller's obligations under this Agreement.

SECTION 14: CHOICE OF LAW

This Agreement shall be interpreted and enforced in accordance with the laws of the state of Oregon, excluding any choice of law rules which may direct the application of the laws of another jurisdiction.

SECTION 15: PARTIAL INVALIDITY AND PURPA REPEAL

It is not the intention of the Parties to violate any laws governing the subject matter of this Agreement. If any of the terms of the Agreement are finally held or determined to be invalid, illegal or void as being contrary to any applicable law or public policy, all other terms of the Agreement shall remain in effect. If any terms are finally held or determined to be invalid, illegal or void, the Parties shall enter into negotiations concerning the terms affected by such decision for the purpose of achieving conformity with requirements of any applicable law and the intent of the Parties to this Agreement.

In the event the Public Utility Regulatory Policies Act (PURPA) is repealed, this Agreement shall not terminate prior to the Termination Date, unless such termination is mandated by state or federal law.

SECTION 16: WAIVER

Any waiver at any time by either Party of its rights with respect to a default under this Agreement or with respect to any other matters arising in connection with this Agreement must be in writing, and such waiver shall not be deemed a waiver with respect to any subsequent default or other matter.

SECTION 17: GOVERNMENTAL JURISDICTION AND AUTHORIZATIONS

This Agreement is subject to the jurisdiction of those governmental agencies having control over either Party or this Agreement. Seller shall at all times maintain in effect all local, state and federal licenses, permits and other approvals as then may be required by law for the construction, operation and maintenance of the Facility, and shall provide upon request copies of the same to PGE.

SECTION 18: SUCCESSORS AND ASSIGNS

This Agreement and all of the terms hereof shall be binding upon and inure to the benefit of the respective successors and assigns of the Parties. No assignment hereof by either Party shall become effective without the written consent of the other Party being first obtained and such consent shall not be unreasonably withheld. Notwithstanding the foregoing, either Party may assign this Agreement without the other Party's consent as part of (a) a sale of all or substantially all of the assigning Party's assets, or (b) a merger, consolidation or other reorganization of the assigning Party.

SECTION 19: ENTIRE AGREEMENT

19.1. This Agreement supersedes all prior agreements, proposals, representations, negotiations, discussions or letters, whether oral or in writing, regarding PGE's purchase of Net Output from the Facility. No modification of this Agreement shall be effective unless it is in writing and signed by both Parties.

19.2. By executing this Agreement, Seller releases PGE from any third party claims related to the Facility, known or unknown, which may have arisen prior to the Effective Date.

SECTION 20: NOTICES

20.1. All notices except as otherwise provided in this Agreement shall be in writing, shall be directed as follows and shall be considered delivered if delivered in person or when deposited in the U.S. Mail, postage prepaid by certified or registered mail and return receipt requested:

To Seller: Rafael Solar, LLC
 1624 NW Crest Pl
 Corvallis, OR 97330





To PGE: Contracts Manager
 QF Contracts, 3WTC0306
 PGE - 121 SW Salmon St.
 Portland, Oregon 97204

20.2 The Parties may change the person to whom such notices are addressed, or their addresses, by providing written notices thereof in accordance with this Section 20.

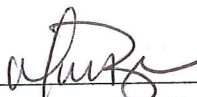
IN WITNESS WHEREOF, the Parties hereto have caused this Agreement to be executed in their respective names as of the Effective Date.

PGE

By: 
Name: Maria M. Pope
Title: SRVP Power Supply & Operations & Resource Strategy
Date: June 21, 2016

PGE Approved By:	
Business Terms	
Credit	
Legal	
Risk Mgt.	

Rafael Solar, LLC

By: 
Name: Dan Orzech
Title: Owner
Date: 6/22/16



EXHIBIT A
DESCRIPTION OF SELLER'S FACILITY

[Seller to Complete]

Seller's facility is a solar photovoltaic generating facility consisting of Canadian Solar CS6X 315P modules (or equivalent) mounted on a fixed racking system, and SMA SC-2200-US inverters (or equivalent) with a nameplate capacity of 2,200 kW AC and 3,082 kW DC. Seller's facility will also include transformers, switchgear, monitoring equipment, fencing and security equipment, and related ancillary equipment necessary to operate a solar photovoltaic generating facility. Exact equipment and nameplate capacity shall be determined by final engineering but shall be materially the same as outlined above.

Seller's facility will interconnect to a PGE distribution line running adjacent to Lafayette Hwy in Marion County, Oregon, at approximately 44°51'36.7"N 123°00'29.9"W.

Seller refers to this facility as the "Rafael Solar Project." Map and single-line drawing of Seller's facility is below.

Rafael Solar – Map

Marion County Taxlot numbers 083W24C 300, 400 & part of 800. Approximate site boundaries outlined on the map below. Final site boundaries will be determined by a survey.



Rafael Solar – Single Line

LINE TYPE LEGEND	
DC CIRCUITS	-----
LOW VOLTAGE AC CIRCUITS	-----
MEDIUM VOLTAGE AC CIRCUITS	-----

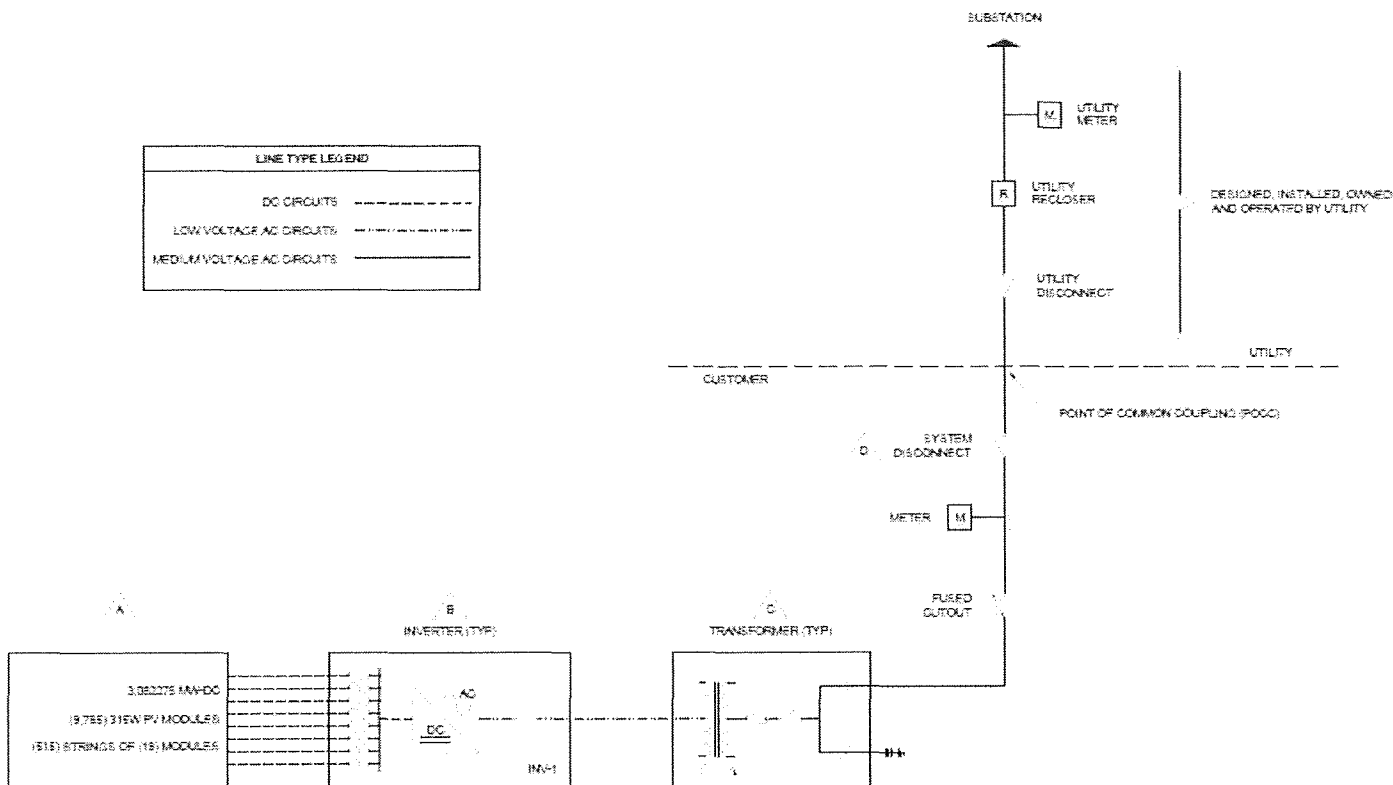

1 PV SYSTEM ONE-LINE DIAGRAM
SCALE: NTS

ID	DESCRIPTION	QTY	SPECIFICATIONS
A	MODULE	9,785	CANADIAN SOLAR, C66X-315P, (OR EQUIVALENT) MODULE WATTAGE: 315 W/STC POWER TOLERANCE: 0.4 - 5 W V _{oc} : 45.10 V V _{mp} : 39.18 A V _{mp} : 36.60 V I _{sc} : 5.61 A TEMP COEFFICIENT (P _{max}): -0.41 %/°C TEMP COEFFICIENT (V _{oc}): -0.31 %/°C MAXIMUM SYSTEM VOLTAGE: 1,000V
B	INVERTER	1	SMA, SUNNY CENTRAL, SC-2200US MAXIMUM OPEN-CURRENT AND OPERATING VOLTAGE: 1,000 V/DC MAX AC POWER: 2,200 kVA NOMINAL AC VOLTAGE (LINE TO LINE): 385 V MAX AC OUTPUT CURRENT: 3,300 A CERTIFICATIONS: UL 1741, UL 1998, IEEE 1547
C	TRANSFORMER	1	2200 kVA PRIMARY VOLTAGE: TBD SECONDARY VOLTAGE: 385 V SYSTEM IMPEDANCE (%): 5.75 % MV CONNECTION: 500 A DEAD FRONT BUSHINGS, LOOP FEED MV FUSING: PROTECTIVE LINK IN SERIES WITH CURRENT LIMITING FUSE MV DISCONNECT: 2-POSITION, 200A, INTEGRATED LOAD BREAK SWITCH
D	SYSTEM DISCONNECT	1	4-WAY OPERATED AIR-BREAK SWITCH

2 EQUIPMENT SCHEDULE
SCALE: NTS

EXHIBIT B
REQUIRED FACILITY DOCUMENTS

[Seller list all permits and authorizations required for this project]

Seller's Generation Interconnection Agreement

Lease Agreement

Conditional Use Permit issued by Marion County

Building and Electrical Permits issued by Marion County

Access Permit (if required by Marion County)

FERC Qualifying Facility self-certification

EXHIBIT C START-UP TESTING

Required start-up test are those checks and tests necessary to determine that all features and equipment, systems, and subsystems have been properly designed, manufactured, installed and adjusted, function properly, and are capable of operating simultaneously in such condition that the Facility is capable of continuous delivery into PGE's electrical system, which may include but are not limited to (as applicable):

1. Safety plan during startup and commissioning
2. Review of all QA/QC testing on the DC and AC sides of inverters
3. Confirm testing and energizing inverters in conformance with manufacturer's Recommended procedures; note operating voltages; and confirm inverter is performing as expected
4. Energizing transformers
5. Under full sun conditions, and after at least 15 minutes of operation, taking and recording PV Plant operating data-such as but not limited to MWoc, MWAc, Voe, VAc, Ioc, IAc, Solar Radiation, etc.
6. Testing the system control and monitoring system to verify that it is performing correctly
7. Testing the communication system for offsite monitoring
8. Testing the Plant metering and protective relaying to verify they meet utility requirements
9. Documentation of successful startup and commissioning procedure
10. Written notification submitted by Contractor to Owner that the completion of Acceptance Testing and Commissioning has occurred

EXHIBIT D
SCHEDULE

[Attach currently in-effect Schedule 201]

Section 6

**SCHEDULE 201
QUALIFYING FACILITY 10 MW or LESS
AVOIDED COST POWER PURCHASE INFORMATION**

PURPOSE

To provide information about Standard Avoided Costs and Renewable Avoided Costs, Standard Power Purchase Agreements (PPA) and Negotiated PPAs, power purchase prices and price options for power delivered by a Qualifying Facility (QF) to the Company with nameplate capacity of 10,000 kW (10MW) or less.

AVAILABLE

To owners of QFs making sales of electricity to the Company in the State of Oregon (Seller).

APPLICABLE

For power purchased from small power production or cogeneration facilities that are QFs as defined in 18 Code of Federal Regulations (CFR) Section 292, that meet the eligibility requirements described herein and where the energy is delivered to the Company's system and made available for Company purchase pursuant to a Standard PPA.

ESTABLISHING CREDITWORTHINESS

The Seller must establish creditworthiness prior to service under this schedule. For a Standard PPA, a Seller may establish creditworthiness with a written acknowledgment that it is current on all existing debt obligations and that it was not a debtor in a bankruptcy proceeding within the preceding 24 months. If the Seller is not able to establish creditworthiness, the Seller must provide security deemed sufficient by the Company as set forth in the Standard PPA.

POWER PURCHASE INFORMATION

A Seller may call the Power Production Coordinator at (503) 464-8000 to obtain more information about being a Seller or how to apply for service under this schedule.

PPA

In accordance with terms set forth in this schedule and the Commission's Rules as applicable, the Company will purchase any Energy in excess of station service (power necessary to produce generation) and amounts attributable to conversion losses, which are made available from the Seller.

A Seller must execute a PPA with the Company prior to delivery of power to the Company. The agreement will have a term of up to 20 years as selected by the QF.

A QF with a nameplate capacity rating of 10 MW or less as defined herein may elect the option of a Standard PPA.

SCHEDULE 201 (Continued)

PPA (Continued)

Any Seller may elect to negotiate a PPA with the Company. Such negotiation will comply with the requirements of the Federal Energy Regulatory Commission (FERC), and the Commission including the guidelines in Order No. 07-360, and Schedule 202. Negotiations for power purchase pricing will be based on either the filed Standard Avoided Costs or Renewable Avoided Costs in effect at that time.

STANDARD PPA (Nameplate capacity of 10 MW or less)

A Seller choosing a Standard PPA will complete all informational and price option selection requirements in the applicable Standard PPA and submit the executed Agreement to the Company prior to service under this schedule. The Standard PPA is available at www.portlandgeneral.com. The available Standard PPAs are:

- Standard In-System Non-Variable Power Purchase Agreement
- Standard Off-System Non-Variable Power Purchase Agreement
- Standard In-System Variable Power Purchase Agreement
- Standard Off-System Variable Power Purchase Agreement
- Standard Renewable In-System Non-Variable Power Purchase Agreement
- Standard Renewable Off-System Non-Variable Power Purchase Agreement
- Standard Renewable In-System Variable Power Purchase Agreement
- Standard Renewable Off-System Variable Power Purchase Agreement

The Standard PPAs applicable to variable resources are available only to QFs utilizing wind, solar or run of river hydro as the primary motive force.

GUIDELINES FOR 10 MW OR LESS FACILITIES ELECTING STANDARD PPA

To execute the Standard PPA the Seller must complete all of the general project information requested in the applicable Standard PPA.

When all information required in the Standard PPA has been received in writing from the Seller, the Company will respond within 15 business days with a draft Standard PPA.

The Seller may request in writing that the Company prepare a final draft Standard PPA. The Company will respond to this request within 15 business days. In connection with such request, the QF must provide the Company with any additional or clarified project information that the Company reasonably determines to be necessary for the preparation of a final draft Standard PPA.

When both parties are in full agreement as to all terms and conditions of the draft Standard PPA, the Company will prepare and forward to the Seller a final executable version of the agreement within 15 business days. Following the Company's execution, an executed copy will be returned to the Seller. Prices and other terms and conditions in the PPA will not be final and binding until the Standard PPA has been executed by both parties.

SCHEDULE 201 (Continued)

OFF-SYSTEM PPA

A Seller with a facility that interconnects with an electric system other than the Company's electric system may enter into a PPA with the Company after following the applicable Standard or Negotiated PPA guidelines and making the arrangements necessary for transmission of power to the Company's system.

BASIS FOR POWER PURCHASE PRICE

AVOIDED COST SUMMARY

The power purchase prices are based on either the Company's Standard Avoided Costs or Renewable Avoided Costs in effect at the time the agreement is executed. Avoided Costs are defined in 18 CFR 292.101(6) as "the incremental costs to an electric utility of electric energy or capacity or both which, but for the purchase from the qualifying facility or qualifying facilities, such utility would generate itself or purchase from another source."

Monthly On-Peak prices are included in both the Standard Avoided Costs as listed in Tables 1a, 2a, and 3a and Renewable Avoided Costs as listed in Tables 4a, 5a, and 6a. Monthly Off-Peak prices are included in both the Standard Avoided Costs as listed in Tables 1b, 2b, and 3b and Renewable Avoided Costs as listed in Tables 4b, 5b, and 6b.

ON-PEAK PERIOD

The On-Peak period is 6:00 a.m. until 10:00 p.m., Monday through Saturday.

OFF-PEAK PERIOD

The Off-Peak period is 10:00 p.m. until 6:00 a.m., Monday through Saturday, and all day on Sunday.

Standard Avoided Costs are based on forward market price estimates through the Resource Sufficiency Period, the period of time during which the Company's Standard Avoided Costs are associated with incremental purchases of Energy and capacity from the market. For the Resource Deficiency Period, the Standard Avoided Costs reflect the fully allocated costs of a natural gas fueled combined cycle combustion turbine (CCCT) including fuel and capital costs. The CCCT Avoided Costs are based on the variable cost of Energy plus capitalized Energy costs at a 93% capacity factor based on a natural gas price forecast, with prices modified for shrinkage and transportation costs.

Renewable Avoided Costs are based on forward market price estimates through the Renewable Resource Sufficiency Period, the period of time during which the Company's Renewable Avoided Costs are associated with incremental purchases of energy and capacity from the market. For the Renewable Resource Deficiency Period, the Renewable Avoided Costs reflect the fully allocated costs of a wind plant including capital costs.

Effective for service
on and after September 23, 2015

SCHEDULE 201 (Continued)

PRICING FOR STANDARD PPA

Pricing represents the purchase price per MWh the Company will pay for electricity delivered to a Point of Delivery (POD) within the Company's service territory pursuant to a Standard PPA up to the nameplate rating of the QF in any hour. Any Energy delivered in excess of the nameplate rating will be purchased at the applicable Off-Peak Prices for the selected pricing option.

The Standard PPA pricing will be based on either the Standard or Renewable Avoided Costs in effect at the time the agreement is executed.

The Company will pay the Seller either the Off-Peak Standard Avoided Cost pursuant to Tables 1b, 2b, or 3b or the Off-Peak Renewable Avoided Costs pursuant to Tables 4b, 5b, or 6b for: (a) all Net Output delivered prior to the Commercial Operation Date; (b) all Net Output deliveries greater than Maximum Net Output in any PPA year; (c) any generation subject to and as adjusted by the provisions of Section 4.3 of the Standard PPA; (d) Net Output delivered in the Off-Peak Period; and (e) deliveries above the nameplate capacity in any hour. The Company will pay the Seller either the On-Peak Standard Avoided Cost pursuant to Tables 1a, 2a, or 3a or the On-Peak Renewable Avoided Costs pursuant to Tables 4a, 5a, or 6a for all other Net Output. (See the PPA for defined terms.)

1) Standard Fixed Price Option

The Standard Fixed Price Option is based on Standard Avoided Costs including forecasted natural gas prices. It is available to all QFs.

This option is available for a maximum term of 15 years. Prices will be as established at the time the Standard PPA is executed and will be equal to the Standard Avoided Costs in Tables 1a and 1b, 2a and 2b, or 3a and 3c, depending on the type of QF, effective at execution. QFs using any resource type other than wind and solar are assumed to be Base Load QFs.

Prices paid to the Seller under the Standard Fixed Price Option include adjustments for the capacity contribution of the QF resource type relative to that of the avoided proxy resource. Both the Base Load QF resources (Tables 1a and 1b) and the avoided proxy resource, the basis used to determine Standard Avoided Costs for the Standard Fixed Price Option, are assumed to have a capacity contribution to peak of 100%. The capacity contribution for Wind QF resources (Tables 2a and 2b) is assumed to be 5%. The capacity contribution for Solar QF resources (Tables 3a and 3b) is assumed to be 5%.

Prices paid to the Seller under the Standard Fixed Price Option for Wind QFs (Tables 2a and 2b) include a reduction for the wind integration costs in Table 7. However, if the Wind QF is outside of PGE's Balancing Authority Area as contemplated in the Commission's Order No. 14-058, the Seller is paid the wind integration charges in Table 7, in addition to the prices listed in Tables 2a and 2b, for a net-zero effect.

Effective for service
on and after September 23, 2015

SCHEDULE 201 (Continued)

PRICING OPTIONS FOR STANDARD PPA (Continued)
Standard Fixed Price Option (Continued)

Sellers with PPAs exceeding 15 years will receive pricing equal to the Mid-C Index Price for all years up to five in excess of the initial 15.

Effective for service
on and after September 23, 2015

SCHEDULE 201 (Continued)

PRICING OPTIONS FOR STANDARD PPA (Continued)
Standard Fixed Price Option (Continued)

TABLE 1a												
Avoided Costs												
Standard Fixed Price Option for Base Load QF												
On-Peak Forecast (\$/MWH)												
Year	Jan	Feb	Mar	Apr	May	Jun	Jul	Aug	Sep	Oct	Nov	Dec
2015	31.13	25.13	26.13	21.88	22.88	25.13	33.13	34.73	29.63	27.38	28.88	33.13
2016	31.43	30.01	28.93	25.51	24.81	23.08	31.90	36.26	32.22	30.97	31.97	34.43
2017	34.12	32.56	29.20	28.13	27.35	25.40	34.51	39.26	34.86	33.83	34.92	37.63
2018	36.46	34.80	31.19	29.53	28.71	26.67	37.01	42.11	37.38	36.92	37.09	39.97
2019	38.14	36.40	32.63	30.89	30.03	27.89	38.72	44.06	39.11	37.58	38.80	41.81
2020	40.36	38.51	34.52	32.68	31.77	29.50	40.97	46.62	41.38	39.76	41.06	44.25
2021	78.65	78.41	74.08	73.15	73.29	73.45	73.59	73.74	73.90	74.05	76.07	77.39
2022	79.87	80.05	78.71	76.75	76.53	76.61	76.77	76.94	77.11	77.75	80.48	81.61
2023	82.88	82.91	80.52	79.06	78.47	78.48	78.64	78.81	78.99	79.72	82.44	83.38
2024	85.05	84.50	82.79	81.04	80.24	79.89	80.07	80.24	80.42	81.68	83.94	84.91
2025	87.42	86.98	85.17	83.82	83.53	83.72	83.91	84.10	84.30	84.97	88.09	89.06
2026	93.67	93.90	93.15	91.55	91.31	91.55	91.77	92.00	92.24	93.05	96.36	97.00
2027	98.91	99.16	94.04	92.43	92.18	92.41	92.63	92.86	93.10	93.79	97.14	98.19
2028	99.59	99.83	95.18	93.58	93.32	93.56	93.78	94.01	94.25	94.96	98.47	99.54
2029	102.08	101.44	98.36	96.44	95.98	96.23	96.46	96.70	96.95	97.87	101.14	103.35
2030	104.39	104.04	99.48	97.63	97.34	97.59	97.83	98.07	98.32	99.06	102.58	105.91
2031	105.92	105.62	101.91	99.62	99.32	99.57	99.81	100.05	100.31	101.05	104.65	105.79
2032	107.68	107.37	103.59	101.26	100.94	101.20	101.44	101.69	101.95	102.73	106.38	107.54
2033	110.15	109.84	105.98	103.61	103.29	103.55	103.80	104.05	104.32	105.10	108.83	110.01
2034	112.43	112.11	108.18	105.75	105.43	105.69	105.95	106.21	106.48	107.28	111.08	112.29
2035	114.62	114.29	110.28	107.81	107.48	107.75	108.01	108.27	108.55	109.37	113.24	114.47
2036	116.98	116.65	112.56	110.04	109.70	109.97	110.24	110.51	110.79	111.62	115.57	116.83
2037	119.72	119.38	115.21	112.64	112.29	112.57	112.84	113.12	113.41	114.26	118.29	119.57
2038	122.36	122.01	117.76	115.14	114.79	115.08	115.35	115.63	115.93	116.79	120.90	122.21
2039	124.88	124.52	120.19	117.52	117.16	117.45	117.73	118.02	118.32	119.20	123.39	124.72
2040	127.74	127.37	122.95	120.23	119.86	120.16	120.45	120.74	121.04	121.94	126.22	127.57

Effective for service
on and after September 23, 2015

SCHEDULE 201 (Continued)

PRICING OPTIONS FOR STANDARD PPA (Continued)
Standard Fixed Price Option (Continued)

TABLE 1b												
Avoided Costs												
Standard Fixed Price Option for Base Load QF												
Off-Peak Forecast (\$/MWH)												
Year	Jan	Feb	Mar	Apr	May	Jun	Jul	Aug	Sep	Oct	Nov	Dec
2015	26.88	20.38	20.88	15.88	17.88	19.13	23.88	26.13	25.63	23.13	25.38	28.38
2016	27.06	25.99	23.32	18.54	16.65	13.43	23.13	27.74	25.51	27.30	27.97	30.11
2017	30.27	29.06	26.04	21.47	19.23	15.43	25.37	30.49	28.02	29.93	30.67	33.03
2018	32.60	31.29	28.03	22.20	19.89	15.96	27.80	33.43	30.71	32.89	33.71	36.32
2019	34.42	33.04	29.59	23.42	20.98	16.82	29.35	35.30	32.42	34.73	35.60	38.36
2020	36.91	35.42	31.72	25.08	22.46	17.99	31.45	37.85	34.75	37.24	38.17	41.14
2021	40.11	39.87	35.54	34.60	34.75	34.90	35.05	35.20	35.36	35.51	37.52	38.85
2022	40.59	40.76	39.42	37.47	37.25	37.32	37.48	37.65	37.82	38.46	41.19	42.33
2023	42.71	42.74	40.35	38.89	38.29	38.30	38.47	38.64	38.82	39.55	42.26	43.21
2024	44.36	43.81	42.10	40.35	39.55	39.21	39.38	39.55	39.73	40.99	43.26	44.22
2025	45.81	45.38	43.57	42.22	41.92	42.12	42.30	42.49	42.69	43.37	46.48	47.48
2026	51.27	51.49	50.74	49.14	48.90	49.14	49.36	49.60	49.84	50.64	53.95	54.59
2027	55.68	55.93	50.81	49.20	48.95	49.18	49.41	49.63	49.87	50.56	53.91	54.97
2028	55.52	55.77	51.12	49.52	49.26	49.50	49.72	49.95	50.19	50.90	54.41	55.48
2029	57.17	56.53	53.44	51.52	51.07	51.31	51.55	51.79	52.04	52.76	56.23	58.44
2030	58.61	58.26	53.70	51.85	51.57	51.81	52.05	52.29	52.54	53.28	56.80	60.13
2031	59.26	58.95	55.25	52.96	52.65	52.90	53.14	53.39	53.64	54.40	57.98	59.12
2032	60.42	60.11	56.33	54.00	53.68	53.94	54.18	54.43	54.69	55.46	59.12	60.28
2033	61.67	61.36	57.50	55.13	54.81	55.07	55.32	55.57	55.84	56.62	60.35	61.53
2034	62.85	62.53	58.60	56.18	55.85	56.12	56.37	56.63	56.90	57.70	61.50	62.71
2035	64.25	63.92	59.91	57.44	57.11	57.38	57.64	57.90	58.18	59.00	62.87	64.10
2036	65.80	65.47	61.38	58.86	58.52	58.80	59.06	59.33	59.61	60.44	64.40	65.65
2037	67.39	67.04	62.87	60.31	59.96	60.24	60.51	60.79	61.07	61.92	65.95	67.23
2038	69.02	68.67	64.42	61.80	61.44	61.73	62.01	62.29	62.58	63.45	67.56	68.86
2039	70.51	70.15	65.82	63.14	62.78	63.08	63.36	63.64	63.94	64.83	69.02	70.35
2040	72.31	71.95	67.53	64.81	64.44	64.74	65.02	65.32	65.62	66.52	70.79	72.15

Effective for service on and after September 23, 2015

SCHEDULE 201 (Continued)

PRICING OPTIONS FOR STANDARD PPA (Continued)
Standard Fixed Price Option (Continued)

TABLE 2a												
Avoided Costs												
Standard Fixed Price Option for Wind QF												
On-Peak Forecast (\$/MWH)												
Year	Jan	Feb	Mar	Apr	May	Jun	Jul	Aug	Sep	Oct	Nov	Dec
2015	27.36	21.36	22.36	18.11	19.11	21.36	29.36	30.96	25.86	23.61	25.11	29.36
2016	27.59	26.17	23.09	21.67	20.97	19.22	28.06	32.42	28.38	27.13	28.13	30.59
2017	30.21	28.65	25.29	24.22	23.44	21.49	30.60	35.35	30.95	29.92	31.01	33.72
2018	32.47	30.81	27.20	25.54	24.72	22.68	33.02	38.12	33.39	31.93	33.10	35.98
2019	34.07	32.33	28.56	26.82	25.96	23.82	34.65	39.99	35.04	33.51	34.73	37.74
2020	36.21	34.36	30.37	28.53	27.62	25.35	36.82	42.47	37.23	35.61	36.91	40.10
2021	37.81	37.56	33.23	32.30	32.45	32.60	32.75	32.90	33.05	33.21	35.22	36.54
2022	38.24	38.42	37.08	35.12	34.90	34.98	35.14	35.30	35.47	36.11	38.85	39.98
2023	40.33	40.36	37.97	36.51	35.91	35.92	36.09	36.26	36.43	37.17	39.88	40.83
2024	41.92	41.37	39.66	37.92	37.11	36.77	36.94	37.12	37.30	38.56	40.82	41.79
2025	43.33	42.90	41.09	39.74	39.44	39.64	39.82	40.02	40.21	40.89	44.00	45.00
2026	48.74	48.96	48.21	46.61	46.37	46.61	46.83	47.07	47.31	48.11	51.42	52.06
2027	53.11	53.35	48.23	46.62	46.37	46.60	46.83	47.06	47.29	47.99	51.33	52.39
2028	52.90	53.14	48.49	46.89	46.63	46.87	47.10	47.32	47.56	48.27	51.78	52.85
2029	54.50	53.85	50.77	48.85	48.40	48.64	48.87	49.11	49.36	50.09	53.55	55.76
2030	55.88	55.53	50.97	49.12	48.83	49.08	49.32	49.56	49.81	50.55	54.07	57.40
2031	56.47	56.17	52.46	50.18	49.87	50.12	50.36	50.60	50.86	51.61	55.20	56.34
2032	57.57	57.26	53.48	51.15	50.84	51.09	51.34	51.59	51.85	52.62	56.27	57.43
2033	58.79	58.47	54.62	52.24	51.92	52.18	52.43	52.68	52.95	53.74	57.46	58.65
2034	59.91	59.59	55.66	53.24	52.91	53.18	53.43	53.69	53.96	54.76	58.56	59.77
2035	61.25	60.92	56.91	54.44	54.11	54.38	54.64	54.90	55.18	56.00	59.87	61.10
2036	62.73	62.40	58.31	55.79	55.45	55.72	55.99	56.26	56.54	57.37	61.32	62.58
2037	64.26	63.92	59.75	57.18	56.83	57.12	57.39	57.66	57.95	58.80	62.83	64.11
2038	65.84	65.49	61.24	58.62	58.26	58.55	58.82	59.11	59.40	60.27	64.37	65.69
2039	67.26	66.91	62.57	59.90	59.54	59.84	60.12	60.40	60.70	61.58	65.77	67.11
2040	69.00	68.64	64.22	61.50	61.13	61.43	61.71	62.01	62.31	63.21	67.49	68.84

Effective for service on and after September 23, 2015

SCHEDULE 201 (Continued)

PRICING OPTIONS FOR STANDARD PPA (Continued)
Standard Fixed Price Option (Continued)

TABLE 2b												
Avoided Costs												
Standard Fixed Price Option for Wind QF												
Off-Peak Forecast (\$/MWH)												
Year	Jan	Feb	Mar	Apr	May	Jun	Jul	Aug	Sep	Oct	Nov	Dec
2015	23.11	16.61	17.11	12.11	14.11	15.36	20.11	22.36	21.86	19.36	21.61	24.61
2016	23.22	22.15	19.48	14.70	12.81	9.59	19.29	23.90	21.67	23.46	24.13	26.27
2017	26.36	25.15	22.13	17.56	15.32	11.52	21.46	26.58	24.11	26.02	26.76	29.12
2018	28.61	27.30	24.04	18.21	15.90	11.97	23.81	29.44	26.72	28.90	29.72	32.33
2019	30.35	28.97	25.52	19.35	16.91	12.75	25.28	31.23	28.35	30.66	31.53	34.29
2020	32.76	31.27	27.57	20.93	18.31	13.84	27.30	33.70	30.60	33.09	34.02	36.99
2021	35.88	35.64	31.31	30.37	30.52	30.67	30.82	30.97	31.13	31.28	33.29	34.62
2022	36.28	36.45	35.11	33.16	32.94	33.01	33.17	33.34	33.51	34.15	36.88	38.02
2023	38.32	38.35	35.96	34.50	33.90	33.91	34.08	34.25	34.43	35.16	37.87	38.62
2024	39.89	39.34	37.63	35.88	35.08	34.74	34.91	35.08	35.26	36.52	38.79	39.75
2025	41.25	40.82	39.01	37.66	37.36	37.56	37.74	37.93	38.13	38.81	41.92	42.92
2026	46.62	46.84	46.09	44.49	44.25	44.49	44.71	44.95	45.19	45.99	49.30	49.94
2027	50.94	51.19	46.07	44.46	44.21	44.44	44.67	44.89	45.13	45.82	49.17	50.23
2028	50.69	50.94	46.29	44.69	44.43	44.67	44.89	45.12	45.36	46.07	49.58	50.65
2029	52.25	51.61	48.52	46.60	46.15	46.39	46.63	46.87	47.12	47.84	51.31	53.52
2030	53.59	53.24	48.68	46.83	46.55	46.79	47.03	47.27	47.52	48.26	51.78	55.11
2031	54.14	53.83	50.13	47.84	47.53	47.78	48.02	48.27	48.52	49.28	52.86	54.00
2032	55.21	54.90	51.12	48.79	48.47	48.73	48.97	49.22	49.48	50.25	53.91	55.07
2033	56.36	56.05	52.19	49.82	49.50	49.76	50.01	50.26	50.53	51.31	55.04	56.22
2034	57.43	57.11	53.18	50.76	50.43	50.70	50.95	51.21	51.48	52.28	56.08	57.29
2035	58.73	58.40	54.39	51.92	51.59	51.86	52.12	52.38	52.66	53.48	57.35	58.58
2036	60.17	59.84	55.75	53.23	52.89	53.17	53.43	53.70	53.98	54.81	58.77	60.02
2037	61.65	61.30	57.13	54.57	54.22	54.50	54.77	55.05	55.33	56.18	60.21	61.49
2038	63.17	62.82	58.57	55.95	55.59	55.88	56.16	56.44	56.73	57.60	61.71	63.01
2039	64.55	64.19	59.86	57.18	56.82	57.12	57.40	57.68	57.98	58.87	63.06	64.39
2040	66.23	65.87	61.45	58.73	58.36	58.66	58.94	59.24	59.54	60.44	64.71	66.07

Effective for service on and after September 23, 2015

SCHEDULE 201 (Continued)

PRICING OPTIONS FOR STANDARD PPA (Continued)
Standard Fixed Price Option (Continued)

TABLE 3a												
Avoided Costs												
Standard Fixed Price Option for Solar QF												
On-Peak Forecast (\$/MWH)												
Year	Jan	Feb	Mar	Apr	May	Jun	Jul	Aug	Sep	Oct	Nov	Dec
2015	31.13	25.13	26.13	21.88	22.88	25.13	33.13	34.73	29.63	27.38	28.88	33.13
2016	31.43	30.01	26.93	25.51	24.81	23.06	31.90	36.26	32.22	30.97	31.97	34.43
2017	34.12	32.56	29.20	28.13	27.35	25.40	34.51	39.26	34.86	33.83	34.92	37.63
2018	36.46	34.80	31.19	29.53	28.71	26.67	37.01	42.11	37.38	35.92	37.09	39.97
2019	38.14	36.40	32.63	30.89	30.03	27.89	38.72	44.06	39.11	37.58	38.80	41.81
2020	40.36	38.51	34.52	32.68	31.77	29.50	40.97	46.62	41.38	39.76	41.06	44.25
2021	42.04	41.79	37.46	36.53	36.68	36.83	36.98	37.13	37.28	37.44	39.45	40.77
2022	42.55	42.73	41.39	39.43	39.21	39.29	39.45	39.61	39.78	40.42	43.16	44.29
2023	44.72	44.75	42.36	40.90	40.30	40.31	40.48	40.65	40.82	41.56	44.27	45.22
2024	46.39	45.84	44.13	42.39	41.58	41.24	41.41	41.59	41.77	43.03	45.29	46.26
2025	47.89	47.46	45.65	44.30	44.00	44.20	44.38	44.58	44.77	45.45	48.56	49.56
2026	53.39	53.61	52.86	51.26	51.02	51.26	51.48	51.72	51.96	52.76	56.07	56.71
2027	57.85	58.09	52.97	51.36	51.11	51.34	51.57	51.80	52.03	52.73	56.07	57.13
2028	57.73	57.97	53.32	51.72	51.46	51.70	51.93	52.15	52.39	53.10	56.61	57.68
2029	59.42	58.77	55.69	53.77	53.32	53.56	53.79	54.03	54.28	55.01	58.47	60.68
2030	60.90	60.55	55.99	54.14	53.85	54.10	54.34	54.58	54.83	55.57	59.09	62.42
2031	61.59	61.29	57.58	55.30	54.99	55.24	55.48	55.72	55.98	56.73	60.32	61.46
2032	62.78	62.47	58.69	56.36	56.05	56.30	56.55	56.80	57.06	57.83	61.48	62.64
2033	64.10	63.78	59.93	57.55	57.23	57.49	57.74	57.99	58.26	59.05	62.77	63.96
2034	65.33	65.01	61.08	58.66	58.33	58.60	58.85	59.11	59.38	60.18	63.98	65.19
2035	66.77	66.44	62.43	59.96	59.63	59.90	60.16	60.42	60.70	61.52	65.39	66.62
2036	68.38	68.03	63.94	61.42	61.08	61.35	61.62	61.89	62.17	63.00	66.95	68.21
2037	70.00	69.66	65.49	62.92	62.57	62.86	63.13	63.40	63.69	64.54	68.57	69.85
2038	71.69	71.34	67.09	64.47	64.11	64.40	64.67	64.96	65.25	66.12	70.22	71.53
2039	73.22	72.87	68.53	65.86	65.50	65.80	66.08	66.36	66.66	67.54	71.73	73.07
2040	75.08	74.72	70.30	67.58	67.21	67.51	67.79	68.08	68.39	69.29	73.57	74.92

Effective for service on and after September 23, 2015

SCHEDULE 201 (Continued)

PRICING OPTIONS FOR STANDARD PPA (Continued)
Standard Fixed Price Option (Continued)

TABLE 3b												
Avoided Costs												
Standard Fixed Price Option for Solar QF												
Off-Peak Forecast (\$/MWH)												
Year	Jan	Feb	Mar	Apr	May	Jun	Jul	Aug	Sep	Oct	Nov	Dec
2015	26.88	20.38	20.88	15.88	17.88	19.13	23.88	26.13	25.63	23.13	25.38	29.38
2016	27.06	25.99	23.32	18.54	16.65	13.43	23.13	27.74	25.51	27.30	27.97	30.11
2017	30.27	29.06	26.04	21.47	19.23	15.43	25.37	30.49	28.02	29.93	30.67	33.03
2018	32.60	31.29	28.03	22.20	19.89	15.96	27.80	33.43	30.71	32.89	33.71	36.32
2019	34.42	33.04	29.59	23.42	20.98	16.82	29.35	35.30	32.42	34.73	35.60	38.36
2020	36.91	35.42	31.72	25.08	22.46	17.99	31.45	37.85	34.75	37.24	38.17	41.14
2021	40.11	39.87	35.54	34.60	34.75	34.90	35.05	35.20	35.36	35.51	37.52	38.85
2022	40.59	40.76	39.42	37.47	37.25	37.32	37.48	37.65	37.82	38.46	41.19	42.33
2023	42.71	42.74	40.35	38.89	38.29	38.30	38.47	38.64	38.82	39.55	42.26	43.21
2024	44.36	43.81	42.10	40.35	39.55	39.21	39.38	39.55	39.73	40.99	43.26	44.22
2025	45.81	45.38	43.57	42.22	41.92	42.12	42.30	42.49	42.69	43.37	46.48	47.48
2026	51.27	51.49	50.74	49.14	48.90	49.14	49.36	49.60	49.84	50.64	53.95	54.59
2027	55.68	55.93	50.81	49.20	48.95	49.18	49.41	49.63	49.87	50.56	53.91	54.97
2028	55.52	55.77	51.12	49.52	49.26	49.50	49.72	49.95	50.19	50.90	54.41	55.48
2029	57.17	56.53	53.44	51.52	51.07	51.31	51.55	51.79	52.04	52.76	56.23	58.44
2030	58.61	58.26	53.70	51.85	51.57	51.81	52.05	52.29	52.54	53.28	56.80	60.13
2031	59.26	58.95	55.25	52.96	52.65	52.90	53.14	53.39	53.64	54.40	57.98	59.12
2032	60.42	60.11	56.33	54.00	53.68	53.94	54.18	54.43	54.69	55.46	59.12	60.28
2033	61.67	61.36	57.50	55.13	54.81	55.07	55.32	55.57	55.84	56.62	60.35	61.53
2034	62.85	62.53	58.60	56.18	55.85	56.12	56.37	56.63	56.90	57.70	61.50	62.71
2035	64.25	63.92	59.91	57.44	57.11	57.38	57.64	57.90	58.18	59.00	62.87	64.10
2036	65.80	65.47	61.38	58.86	58.52	58.80	59.06	59.33	59.61	60.44	64.40	65.65
2037	67.39	67.04	62.87	60.31	59.96	60.24	60.51	60.79	61.07	61.92	65.95	67.23
2038	69.02	68.67	64.42	61.80	61.44	61.73	62.01	62.29	62.58	63.45	67.56	68.86
2039	70.51	70.15	65.82	63.14	62.78	63.08	63.36	63.64	63.94	64.83	69.02	70.35
2040	72.31	71.95	67.53	64.81	64.44	64.74	65.02	65.32	65.62	66.52	70.79	72.15

Effective for service on and after September 23, 2015

SCHEDULE 201 (Continued)

PRICING OPTIONS FOR STANDARD PPA (Continued)

2) Renewable Fixed Price Option

The Renewable Fixed Price Option is based on Renewable Avoided Costs. It is available only to Renewable QFs that generate electricity from a renewable energy source that may be used by the Company to comply with the Oregon Renewable Portfolio Standard as set forth in ORS 469A.005 to 469A.210.

This option is available for a maximum term of 15 years. Prices will be established at the time the Standard PPA is executed and will be equal to the Renewable Avoided Costs in Tables 4a and 4b, 5a and 5b, or 6a and 6b, depending on the type of QF, effective at execution. QFs using any resource type other than wind and solar are assumed to be Base Load QFs.

Sellers will retain all Environmental Attributes generated by the facility during the Renewable Resource Sufficiency Period. A Renewable QF choosing the Renewable Fixed Price Option must cede all RPS Attributes generated by the facility to the Company during the Renewable Resource Deficiency Period.

Prices paid to the Seller under the Renewable Fixed Price Option include adjustments for the capacity contribution of the QF resource type relative to that of the avoided proxy resource. Both Wind QF resources (Tables 5a and 5b) and the avoided proxy resource, the basis used to determine Renewable Avoided Costs for the Renewable Fixed Price Option, are assumed to have a capacity contribution to peak of 5%. The capacity contribution for Solar QF resources (Tables 6a and 6b) is assumed to be 5%. The capacity contribution for Base Load QF resources (Tables 4a and 4b) is assumed to be 100%.

The Renewable Avoided Costs during the Renewable Resource Deficiency Period reflect an increase for avoided wind integration costs, shown in Table 7.

Prices paid to the Seller under the Renewable Fixed Price Option for Wind QFs (Tables 5a and 5b) include a reduction for the wind integration costs in Table 7, which cancels out wind integration costs included in the Renewable Avoided Costs during the Renewable Resource Deficiency Period. However, if the Wind QF is outside of PGE's Balancing Authority Area as contemplated in the Commission's Order No. 14-058, the Seller is paid the wind integration charges in Table 7, in addition to the prices listed in Tables 5a and 5b.

Sellers with PPAs exceeding 15 years will receive pricing equal to the Mid-C Index Price and will retain all Environmental Attributes generated by the facility for all years up to five in excess of the initial 15.

Effective for service on and after September 23, 2015

SCHEDULE 201 (Continued)

PRICING OPTIONS FOR STANDARD PPA (Continued)
Renewable Fixed Price Option (Continued)

TABLE 4a												
Renewable Avoided Costs												
Renewable Fixed Price Option for Base Load QF												
On-Peak Forecast (\$/MWH)												
Year	Jan	Feb	Mar	Apr	May	Jun	Jul	Aug	Sep	Oct	Nov	Dec
2015	31.13	25.13	26.13	21.88	22.88	25.13	33.13	34.73	29.63	27.38	28.88	33.13
2016	31.58	30.16	27.08	25.66	24.96	23.21	32.05	36.41	32.37	31.12	32.12	34.58
2017	34.27	32.71	29.35	28.28	27.50	25.55	34.66	39.41	35.01	33.98	35.07	37.78
2018	36.61	34.95	31.34	29.68	28.86	26.82	37.16	42.26	37.53	36.07	37.24	40.12
2019	38.30	36.56	32.79	31.05	30.19	28.05	38.88	44.22	39.27	37.74	38.96	41.97
2020	130.42	130.40	129.50	130.04	133.82	132.76	132.39	132.24	130.72	129.58	130.57	129.37
2021	133.36	133.64	131.86	133.13	136.49	135.59	134.91	135.52	133.73	132.54	134.08	132.51
2022	136.24	136.10	133.85	135.90	139.41	138.20	137.67	137.62	136.32	135.14	136.83	135.12
2023	139.39	138.88	136.54	138.99	141.88	141.01	140.60	140.17	139.18	137.81	139.83	138.53
2024	141.20	141.38	139.07	141.45	144.67	143.47	143.33	143.02	142.81	139.99	141.17	141.32
2025	144.44	144.83	142.24	145.02	149.08	147.69	146.57	146.72	145.76	143.11	144.48	144.07
2026	148.08	147.69	145.97	148.54	153.80	149.69	149.69	150.17	149.84	146.23	148.39	147.27
2027	150.98	150.46	148.51	151.01	158.07	152.64	152.20	153.90	152.54	149.20	150.73	150.17
2028	153.78	152.55	150.16	154.12	160.66	154.93	155.77	155.78	154.75	152.38	153.65	152.73
2029	157.02	156.74	153.60	157.59	169.40	159.30	159.39	159.39	159.45	155.48	156.44	156.31
2030	160.28	159.94	157.24	160.66	173.85	164.43	161.89	161.75	163.38	158.51	159.18	159.23
2031	163.23	162.64	160.72	164.67	177.15	169.11	164.90	166.01	166.26	161.75	163.06	162.54
2032	165.75	165.16	163.21	167.22	179.91	171.73	167.46	168.59	168.84	164.26	165.59	165.06
2033	169.59	168.98	166.98	171.09	184.06	175.70	171.33	172.48	172.74	168.06	169.41	168.88
2034	173.01	172.39	170.36	174.55	187.76	179.24	174.79	175.97	176.23	171.46	172.84	172.29
2035	176.35	175.72	173.65	177.91	191.39	182.70	178.16	179.36	179.63	174.76	176.17	175.62
2036	179.40	178.76	176.65	180.99	194.69	185.85	181.24	182.46	182.74	177.79	179.22	178.65
2037	183.23	182.57	180.41	184.85	198.85	189.82	185.10	186.35	186.63	181.58	183.04	182.46
2038	186.76	186.09	183.90	188.42	202.69	193.48	188.68	189.95	190.23	185.08	186.57	185.98
2039	190.37	189.68	187.44	192.05	206.60	197.22	192.32	193.61	193.91	188.65	190.17	189.57
2040	193.66	192.96	190.69	195.37	210.16	200.62	195.64	196.96	197.26	191.92	193.46	192.85

Effective for service
on and after September 23, 2015

SCHEDULE 201 (Continued)

PRICING OPTIONS FOR STANDARD PPA (Continued)
Renewable Fixed Price Option (Continued)

TABLE 4b												
Renewable Avoided Costs												
Renewable Fixed Price Option for Base Load QF												
Off-Peak Forecast (\$/MWH)												
Year	Jan	Feb	Mar	Apr	May	Jun	Jul	Aug	Sep	Oct	Nov	Dec
2015	26.88	20.38	20.88	15.88	17.88	19.13	23.88	26.13	25.63	23.13	25.38	28.38
2016	27.21	26.14	23.47	18.69	16.80	13.58	23.28	27.89	25.66	27.45	28.12	30.26
2017	30.42	29.21	26.19	21.62	19.38	15.58	25.52	30.64	28.17	30.08	30.82	33.18
2018	32.75	31.44	28.18	22.35	20.04	16.11	27.95	33.56	30.86	33.04	33.86	36.47
2019	34.58	33.20	29.75	23.58	21.14	16.98	29.51	35.46	32.58	34.89	35.76	38.52
2020	74.05	74.35	76.18	74.70	70.70	70.98	71.32	72.70	73.76	75.21	74.98	75.50
2021	76.61	75.69	77.70	76.08	72.65	72.71	73.48	73.88	75.25	77.66	74.78	76.80
2022	77.70	77.31	79.96	77.27	73.65	74.12	75.90	74.74	76.69	79.10	76.00	78.21
2023	78.70	78.76	81.53	79.38	74.14	75.53	77.17	76.51	78.04	80.71	77.14	79.80
2024	79.35	79.42	83.14	79.16	74.55	77.78	76.40	76.83	78.61	81.03	79.55	80.29
2025	80.96	80.94	84.88	80.33	74.54	78.20	78.02	79.19	79.32	82.81	82.21	81.48
2026	81.35	82.42	85.28	80.89	75.34	79.31	79.11	79.94	79.12	83.91	82.41	82.47
2027	84.14	84.11	86.28	82.99	75.15	80.77	81.16	80.43	80.90	86.39	83.38	83.99
2028	85.29	86.01	88.97	85.07	74.43	82.57	82.76	81.19	82.83	87.06	84.33	86.62
2029	85.87	86.84	90.61	86.72	68.73	82.93	84.21	82.59	84.39	88.00	86.85	88.12
2030	87.21	88.28	92.46	86.89	68.43	83.64	84.98	85.17	84.95	89.66	88.91	89.94
2031	89.10	90.50	93.69	87.32	69.81	83.38	86.78	86.97	85.14	91.14	90.93	90.04
2032	90.57	92.00	95.23	88.76	70.97	84.75	88.21	88.41	86.54	92.64	92.44	91.53
2033	92.57	94.03	97.34	90.72	72.53	86.63	90.16	90.36	88.46	94.69	94.48	93.55
2034	94.36	95.84	99.22	92.47	73.93	88.30	91.90	92.10	90.16	96.52	96.30	95.36
2035	96.18	97.69	101.13	94.25	75.36	90.00	93.68	93.88	91.90	98.38	98.16	97.20
2036	97.77	99.31	102.80	95.81	76.61	91.49	95.22	95.43	93.42	100.00	99.78	98.80
2037	99.93	101.50	105.07	97.93	78.30	93.51	97.33	97.54	95.49	102.21	101.99	100.99
2038	101.86	103.46	107.10	99.82	79.81	95.31	99.20	99.42	97.33	104.19	103.95	102.93
2039	103.82	105.46	109.17	101.74	81.35	97.15	101.12	101.34	99.21	106.20	105.96	104.92
2040	105.54	107.20	110.97	103.42	82.69	98.76	102.79	103.02	100.85	107.95	107.71	106.65

Effective for service
on and after September 23, 2015

SCHEDULE 201 (Continued)

PRICING OPTIONS FOR STANDARD PPA (Continued)
Renewable Fixed Price Option (Continued)

TABLE 5a												
Renewable Avoided Costs												
Renewable Fixed Price Option for Wind QF												
On-Peak Forecast (\$/MWH)												
Year	Jan	Feb	Mar	Apr	May	Jun	Jul	Aug	Sep	Oct	Nov	Dec
2015	27.36	21.36	22.36	18.11	19.11	21.36	29.36	30.96	25.86	23.61	25.11	29.36
2016	27.74	26.32	23.24	21.82	21.12	19.37	28.21	32.57	28.53	27.28	28.28	30.74
2017	30.36	28.80	25.44	24.37	23.59	21.64	30.75	35.50	31.10	30.07	31.16	33.87
2018	32.62	30.96	27.35	25.69	24.87	22.83	33.17	38.27	33.54	32.08	33.25	36.13
2019	34.23	32.49	28.72	26.98	26.12	23.98	34.81	40.15	35.20	33.67	34.89	37.90
2020	89.69	89.67	88.77	89.31	93.09	92.03	91.66	91.52	90.00	88.85	89.84	88.64
2021	91.73	92.00	90.23	91.50	94.85	93.96	93.28	93.88	92.10	90.91	92.44	90.88
2022	93.81	93.66	91.42	93.47	96.98	95.77	95.23	95.19	93.89	92.71	94.39	92.68
2023	96.01	95.50	93.17	95.61	98.50	97.64	97.23	96.79	95.80	94.43	96.45	95.15
2024	97.25	97.43	95.12	97.50	100.71	99.51	99.38	99.07	98.85	96.03	97.21	97.37
2025	99.51	99.89	97.31	100.08	104.15	102.76	101.63	101.79	100.82	98.17	99.55	99.13
2026	102.27	101.88	100.16	102.74	108.00	103.89	103.89	104.37	104.03	100.42	102.58	101.47
2027	104.29	103.77	101.82	104.32	111.38	105.95	105.51	107.22	105.85	102.51	104.04	103.48
2028	106.19	104.95	102.57	105.53	113.07	107.34	108.18	108.19	107.16	104.79	106.06	105.14
2029	108.51	108.23	105.09	109.08	120.90	110.80	110.89	110.89	110.94	106.98	107.94	107.81
2030	110.84	110.49	107.80	111.21	124.40	114.99	112.45	112.31	113.94	109.07	109.73	109.79
2031	112.82	112.24	110.32	114.27	126.75	118.70	114.90	115.61	115.86	111.35	112.66	112.14
2032	114.68	114.08	112.13	116.15	128.84	120.66	116.38	117.51	117.77	113.18	114.51	113.99
2033	117.23	116.62	114.62	118.73	131.70	123.34	118.97	120.13	120.39	115.70	117.06	116.52
2034	119.48	118.86	116.83	121.02	134.24	125.71	121.26	122.44	122.70	117.93	119.31	118.76
2035	121.80	121.16	119.09	123.36	136.83	128.14	123.60	124.80	125.07	120.21	121.62	121.06
2036	123.79	123.14	121.04	125.37	139.07	130.24	125.63	126.85	127.12	122.17	123.61	123.04
2037	126.54	125.88	123.72	128.16	142.16	133.13	128.42	129.66	129.94	124.89	126.35	125.77
2038	128.98	128.31	126.11	130.63	144.90	135.70	130.89	132.17	132.45	127.30	128.79	128.20
2039	131.47	130.79	128.55	133.16	147.70	138.32	133.42	134.72	135.01	129.76	131.28	130.68
2040	133.62	132.93	130.65	133.33	150.12	140.59	135.61	136.92	137.22	131.88	133.43	132.81

Effective for service
on and after September 23, 2015

SCHEDULE 201 (Continued)

PRICING OPTIONS FOR STANDARD PPA (Continued)
Renewable Fixed Price Option (Continued)

TABLE 5b												
Renewable Avoided Costs												
Renewable Fixed Price Option for Wind QF												
Off-Peak Forecast (\$/MWH)												
Year	Jan	Feb	Mar	Apr	May	Jun	Jul	Aug	Sep	Oct	Nov	Dec
2015	23.11	16.61	17.11	12.11	14.11	15.36	20.11	22.36	21.86	19.36	21.61	24.61
2016	23.37	22.30	19.63	14.85	12.96	9.74	19.44	24.05	21.82	23.61	24.28	26.42
2017	26.51	25.30	22.28	17.71	15.47	11.67	21.61	26.73	24.26	26.17	26.91	29.27
2018	28.76	27.45	24.19	18.36	16.05	12.12	23.96	29.59	26.87	29.05	29.87	32.48
2019	30.51	29.13	25.68	19.51	17.07	12.91	25.44	31.39	28.51	30.82	31.69	34.45
2020	69.90	70.20	72.03	70.55	66.55	66.83	67.17	68.55	69.61	71.06	70.83	71.35
2021	72.38	71.46	73.47	71.85	68.42	68.48	69.25	69.55	71.02	73.43	70.55	72.57
2022	73.39	73.00	75.85	72.96	69.37	69.81	71.59	70.43	72.38	74.79	71.69	73.90
2023	74.31	74.37	77.14	74.99	69.75	71.14	72.78	72.12	73.65	76.32	72.75	75.41
2024	74.88	74.95	78.67	74.69	70.08	73.31	71.93	72.36	74.14	76.56	75.08	75.82
2025	76.40	76.38	80.32	75.77	69.98	73.64	73.46	74.63	74.76	78.25	77.65	76.92
2026	76.70	77.77	80.63	76.24	70.69	74.66	74.46	75.29	74.47	79.26	77.76	77.82
2027	79.40	79.37	81.54	78.25	70.41	76.03	76.42	75.69	76.16	81.65	78.64	79.25
2028	80.46	81.18	84.14	80.24	69.60	77.74	77.93	76.36	78.00	82.23	79.50	81.79
2029	80.95	81.92	85.69	81.80	63.81	78.01	79.29	77.67	79.47	83.08	81.93	83.20
2030	82.19	83.26	87.44	81.87	63.41	78.62	79.96	80.15	79.93	84.64	83.89	84.92
2031	83.98	85.38	88.57	82.20	64.69	78.26	81.66	81.85	80.02	86.02	85.81	84.92
2032	85.36	86.79	90.02	83.55	65.76	79.54	83.00	83.20	81.33	87.43	87.23	86.32
2033	87.26	88.72	92.03	85.41	67.22	81.32	84.85	85.05	83.15	89.38	89.17	88.24
2034	88.94	90.42	93.80	87.05	68.51	82.88	86.48	86.68	84.74	91.10	90.88	89.94
2035	90.66	92.17	95.61	88.73	69.84	84.48	88.16	88.36	86.38	92.86	92.64	91.68
2036	92.14	93.68	97.17	90.18	70.98	85.86	89.59	89.80	87.79	94.37	94.15	93.17
2037	94.19	95.76	99.33	92.19	72.56	87.77	91.59	91.80	89.75	96.47	96.25	95.25
2038	96.01	97.61	101.25	93.97	73.96	89.46	93.35	93.57	91.48	98.34	98.10	97.08
2039	97.86	99.50	103.21	95.78	75.39	91.19	95.16	95.38	93.25	100.24	100.00	98.96
2040	99.46	101.12	104.89	97.34	76.61	92.68	96.71	96.94	94.77	101.87	101.63	100.57

Effective for service
on and after September 23, 2015

SCHEDULE 201 (Continued)

PRICING OPTIONS FOR STANDARD PPA (Continued)
Renewable Fixed Price Option (Continued)

TABLE 6a												
Renewable Avoided Costs												
Renewable Fixed Price Option for Solar QF												
On-Peak Forecast (\$/MWH)												
Year	Jan	Feb	Mar	Apr	May	Jun	Jul	Aug	Sep	Oct	Nov	Dec
2015	31.13	25.13	26.13	21.88	22.88	25.13	33.13	34.73	29.63	27.38	28.88	33.13
2016	31.58	30.16	27.08	25.66	24.96	23.21	32.05	36.41	32.37	31.12	32.12	34.58
2017	34.27	32.71	29.35	28.28	27.50	25.55	34.66	39.41	35.01	33.98	35.07	37.78
2018	36.61	34.95	31.34	29.68	28.86	26.82	37.16	42.26	37.53	36.07	37.24	40.12
2019	38.30	36.56	32.79	31.05	30.19	28.05	36.88	44.22	39.27	37.74	38.96	41.97
2020	93.84	93.82	92.92	93.46	97.24	96.16	95.81	95.67	94.15	93.00	93.99	92.79
2021	95.96	96.23	94.46	95.73	99.08	98.19	97.51	98.11	96.33	95.14	96.67	95.11
2022	98.12	97.97	95.73	97.78	101.29	100.08	99.54	99.50	98.20	97.02	98.70	96.99
2023	100.40	99.89	97.56	100.00	102.89	102.03	101.62	101.18	100.19	98.82	100.84	99.54
2024	101.72	101.90	99.59	101.97	105.18	103.98	103.85	103.54	103.32	100.50	101.68	101.84
2025	104.07	104.45	101.87	104.64	108.71	107.32	106.19	106.35	105.38	102.73	104.11	103.69
2026	106.92	106.53	104.81	107.39	112.65	108.54	108.54	109.02	108.68	105.07	107.23	106.12
2027	109.03	108.51	106.56	109.06	116.12	110.69	110.25	111.96	110.59	107.25	108.78	108.22
2028	111.02	109.79	107.40	111.36	117.90	112.17	113.01	113.02	111.99	109.82	110.89	109.97
2029	113.43	113.15	110.01	114.00	125.82	115.72	115.81	115.81	115.86	111.90	112.86	112.73
2030	115.86	115.51	112.82	116.23	129.42	120.01	117.47	117.33	118.96	114.09	114.75	114.81
2031	117.94	117.36	115.44	119.39	131.87	123.82	119.62	120.73	120.98	116.47	117.78	117.26
2032	119.89	119.29	117.34	121.36	134.05	125.87	121.59	122.72	122.98	118.39	119.72	119.20
2033	122.54	121.93	119.93	124.04	137.01	128.65	124.26	125.44	125.70	121.01	122.37	121.83
2034	124.90	124.28	122.25	126.44	139.66	131.13	126.68	127.86	128.12	123.35	124.73	124.16
2035	127.32	126.68	124.61	128.88	142.35	133.66	129.12	130.32	130.59	125.73	127.14	126.58
2036	129.42	128.77	126.67	131.00	144.70	135.87	131.26	132.48	132.75	127.80	129.24	128.67
2037	132.28	131.62	129.46	133.90	147.90	138.87	134.16	135.40	135.68	130.63	132.09	131.51
2038	134.83	134.16	131.96	136.48	150.75	141.55	136.74	138.02	138.30	133.15	134.64	134.05
2039	137.43	136.75	134.51	139.12	153.66	144.28	139.38	140.68	140.97	135.72	137.24	136.64
2040	139.70	139.01	136.73	141.41	156.20	146.67	141.69	143.00	143.30	137.96	139.51	138.89

Effective for service on and after September 23, 2015

SCHEDULE 201 (Continued)

PRICING OPTIONS FOR STANDARD PPA (Continued)
Renewable Fixed Price Option (Continued)

TABLE 6b												
Renewable Avoided Costs												
Renewable Fixed Price Option for Solar QF												
Off-Peak Forecast (\$/MWH)												
Year	Jan	Feb	Mar	Apr	May	Jun	Jul	Aug	Sep	Oct	Nov	Dec
2015	26.88	20.38	20.88	15.88	17.88	19.13	23.88	26.13	25.63	23.13	25.38	28.38
2016	27.21	26.14	23.47	18.69	16.80	13.58	23.28	27.89	25.66	27.45	28.12	30.26
2017	30.42	29.21	26.19	21.62	19.38	15.58	25.52	30.64	28.17	30.08	30.82	33.18
2018	32.75	31.44	28.18	22.35	20.04	16.11	27.95	33.58	30.86	33.04	33.86	36.47
2019	34.58	33.20	29.75	23.58	21.14	16.98	29.51	35.46	32.58	34.89	35.76	38.52
2020	74.05	74.35	76.18	74.70	70.70	70.98	71.32	72.70	73.76	75.21	74.98	75.50
2021	76.61	75.69	77.70	76.08	72.65	72.71	73.48	73.88	75.25	77.66	74.78	76.80
2022	77.70	77.31	79.96	77.27	73.68	74.12	75.90	74.74	76.69	79.10	76.00	78.21
2023	78.70	78.76	81.63	79.38	74.14	75.53	77.17	76.51	78.04	80.71	77.14	79.80
2024	79.35	79.42	83.14	79.16	74.55	77.78	76.40	76.83	78.61	81.03	79.55	80.29
2025	80.96	80.94	84.88	80.33	74.54	78.20	78.02	79.19	79.32	82.81	82.21	81.48
2026	81.35	82.42	85.28	80.89	75.34	79.31	79.11	79.94	79.12	83.91	82.41	82.47
2027	84.14	84.11	86.28	82.99	75.15	80.77	81.16	80.43	80.90	86.39	83.38	83.99
2028	85.29	86.01	88.97	85.07	74.43	82.57	82.76	81.19	82.83	87.06	84.33	86.62
2029	85.87	86.84	90.61	86.72	68.73	82.93	84.21	82.59	84.39	88.00	86.85	88.12
2030	87.21	88.28	92.46	86.89	68.43	83.64	84.98	85.17	84.95	89.66	88.91	89.94
2031	89.10	90.50	93.69	87.32	69.81	83.38	86.78	86.97	85.14	91.14	90.93	90.04
2032	90.57	92.00	95.23	88.76	70.97	84.75	88.21	88.41	86.54	92.64	92.44	91.53
2033	92.57	94.03	97.34	90.72	72.53	86.63	90.16	90.36	88.46	94.69	94.48	93.55
2034	94.36	95.84	99.22	92.47	73.93	88.30	91.90	92.10	90.16	96.52	96.30	95.36
2035	96.18	97.69	101.13	94.25	75.36	90.00	93.68	93.88	91.90	98.38	98.16	97.20
2036	97.77	99.31	102.80	95.81	76.61	91.49	95.22	95.43	93.42	100.00	99.78	98.80
2037	99.93	101.50	105.07	97.93	78.30	93.51	97.33	97.54	95.49	102.21	101.99	100.99
2038	101.86	103.46	107.10	99.82	79.81	95.31	99.20	99.42	97.33	104.19	103.95	102.93
2039	103.82	105.46	109.17	101.74	81.35	97.15	101.12	101.34	99.21	106.20	105.96	104.82
2040	105.54	107.20	110.97	103.42	82.69	98.76	102.79	103.02	100.85	107.95	107.71	106.65

Effective for service on and after September 23, 2015

SCHEDULE 201 (Continued)

WIND INTEGRATION

TABLE 7	
Wind Integration	
Year	Cost
2015	3.77
2016	3.84
2017	3.91
2018	3.99
2019	4.07
2020	4.15
2021	4.23
2022	4.31
2023	4.39
2024	4.47
2025	4.56
2026	4.65
2027	4.74
2028	4.83
2029	4.92
2030	5.02
2031	5.12
2032	5.21
2033	5.31
2034	5.42
2035	5.52
2036	5.63
2037	5.74
2038	5.85
2039	5.96
2040	6.08

Effective for service
on and after September 23, 2015

SCHEDULE 201 (Continued)

MONTHLY SERVICE CHARGE

Each separately metered QF not associated with a retail Customer account will be charged \$10.00 per month.

INSURANCE REQUIREMENTS

The following insurance requirements are applicable to Sellers with a Standard PPA:

- 1) QFs with nameplate capacity ratings greater than 200 kW are required to secure and maintain a prudent amount of general liability insurance. The Seller must certify to the Company that it is maintaining general liability insurance coverage for each QF at prudent amounts. A prudent amount will be deemed to mean liability insurance coverage for both bodily injury and property damage liability in the amount of not less than \$1,000,000 each occurrence combined single limit, which limits may be required to be increased or decreased by the Company as the Company determines in its reasonable judgment, that economic conditions or claims experience may warrant.
- 2) Such insurance will include an endorsement naming the Company as an additional insured insofar as liability arising out of operations under this schedule and a provision that such liability policies will not be canceled or their limits reduced without 30 days' written notice to the Company. The Seller will furnish the Company with certificates of insurance together with the endorsements required herein. The Company will have the right to inspect the original policies of such insurance.
- 3) QFs with a design capacity of 200 kW or less are encouraged to pursue liability insurance on their own. The Oregon Public Utility Commission in Order No. 05-584 determined that it is inappropriate to require QFs that have a design capacity of 200 kW or less to obtain general liability insurance.

TRANSMISSION AGREEMENTS

If the QF is located outside the Company's service territory, the Seller is responsible for the transmission of power at its cost to the Company's service territory.

INTERCONNECTION REQUIREMENTS

Except as otherwise provided in a generation Interconnection Agreement between the Company and Seller, if the QF is located within the Company's service territory, switching equipment capable of isolating the QF from the Company's system will be accessible to the Company at all times. At the Company's option, the Company may operate the switching equipment described above if, in the sole opinion of the Company, continued operation of the QF in connection with the utility's system may create or contribute to a system emergency.

Effective for service
on and after September 23, 2015

SCHEDULE 201 (Continued)

INTERCONNECTION REQUIREMENTS (Continued)

The QF owner interconnecting with the Company's distribution system must comply with all requirements for interconnection as established pursuant to Commission rule, in the Company's Rules and Regulations (Rule C) or the Company's Interconnection Procedures contained in its FERC Open Access Transmission Tariff (OATT), as applicable. The Seller will bear full responsibility for the installation and safe operation of the interconnection facilities.

DEFINITION OF A SMALL COGENERATION FACILITY OR SMALL POWER PRODUCTION FACILITY ELIGIBLE TO RECEIVE PRICING UNDER THE STANDARD PPA

A QF will be eligible to receive pricing under the Standard PPA if the nameplate capacity of the QF, together with any other electric generating facility using the same motive force, owned or controlled by the Same Person(s) or Affiliated Person(s), and located at the Same Site, does not exceed 10 MW. A Community-Based or Family-Owned QF is exempt from these restrictions.

Definition of Community-Based

- a. A community project (or a community sponsored project) must have a recognized and established organization located within the county of the project or within 50 miles of the project that has a genuine role in helping the project be developed and must have some not insignificant continuing role with or interest in the project after it is completed and placed in service.
- b. After excluding the passive investor whose ownership interests are primarily related to green tag values and tax benefits as the primary ownership benefit, the equity (ownership) interests in a community sponsored project must be owned in substantial percentage (80 percent or more) by the following persons (individuals and entities): (i) the sponsoring organization, or its controlled affiliates; (ii) members of the sponsoring organization (if it is a membership organization) or owners of the sponsorship organization (if it is privately owned); (iii) persons who live in the county in which the project is located or who live a county adjoining the county in which the project is located; or (iv) units of local government, charities, or other established nonprofit organizations active either in the county in which the project is located or active in a county adjoining the county in which the project is located.

Definition of Family-Owned

After excluding the ownership interest of the passive investor whose ownership interests are primarily related to green tag values and tax benefits as the primary ownership benefit, five or fewer individuals own 50 percent or more of the equity of the project entity, or fifteen or fewer individuals own 90 percent or more of the project entity. A "look through" rule applies to closely held entities that hold the equity of the project entity, so that equity held by LLCs, trusts, estates, corporations, partnerships or other similar entities is considered held by the equity owners of the look through entity. An individual is a natural person. In counting to five or fifteen, spouses or children of an equity owner of the project owner who also have an equity interest are aggregated and counted as a single individual.

Effective for service
on and after September 23, 2015

SCHEDULE 201 (Concluded)

DEFINITION OF A SMALL COGENERATION FACILITY OR SMALL POWER PRODUCTION FACILITY ELIGIBLE TO RECEIVE PRICING UNDER THE STANDARD PPA (Continued)

Definition of Person(s) or Affiliated Person(s)

As used above, the term "Same Person(s)" or "Affiliated Person(s)" means a natural person or persons or any legal entity or entities sharing common ownership, management or acting jointly or in concert with or exercising influence over the policies or actions of another person or entity. However, two facilities will not be held to be owned or controlled by the Same Person(s) or Affiliated Person(s) solely because they are developed by a single entity.

Furthermore, two facilities will not be held to be owned or controlled by the Same Person(s) or Affiliated Person(s) if such common person or persons is a "passive investor" whose ownership interest in the QF is primarily related to utilizing production tax credits, green tag values and MACRS depreciation as the primary ownership benefit and the facilities at issue are independent family-owned or community-based projects. A unit of Oregon local government may also be a "passive investor" in a community-based project if the local governmental unit demonstrates that it will not have an equity ownership interest in or exercise any control over the management of the QF and that its only interest is a share of the cash flow from the QF, which share will not exceed 20%. The 20% cash flow share limit may only be exceeded for good cause shown and only with the prior approval of the Commission.

Definition of Same Site

For purposes of the foregoing, generating facilities are considered to be located at the same site as the QF for which qualification for pricing under the Standard PPA is sought if they are located within a five-mile radius of any generating facilities or equipment providing fuel or motive force associated with the QF for which qualification for pricing under the Standard PPA is sought.

Definition of Shared Interconnection and Infrastructure

QFs otherwise meeting the above-described separate ownership test and thereby qualified for entitlement to pricing under the Standard PPA will not be disqualified by utilizing an interconnection or other infrastructure not providing motive force or fuel that is shared with other QFs qualifying for pricing under the Standard PPA so long as the use of the shared interconnection complies with the interconnecting utility's safety and reliability standards, interconnection agreement requirements and Prudent Electrical Practices as that term is defined in the interconnecting utility's approved Standard PPA.

OTHER DEFINITIONS

Mid-C Index Price

As used in this schedule, the daily Mid-C Index Price shall be the Day Ahead Intercontinental Exchange ("ICE") for the bilateral OTC market for energy at the Mid-C Physical for Average

Effective for service
on and after September 23, 2015

SCHEDULE 201 (Continued)

OTHER DEFINITIONS (Continued)

On-Peak Power and Average Off-Peak Power found on the following website: <https://www.theice.com/products/OTC/Physical-Energy/Electricity>. In the event ICE no longer publishes this index, PGE and the Seller agree to select an alternative successor index representative of the Mid-C trading hub.

Definition of RPS Attributes

As used in this schedule, RPS Attributes means all attributes related to the Net Output generated by the Facility that are required in order to provide PGE with "qualifying electricity," as that term is defined in Oregon's Renewable Portfolio Standard Act, Ore. Rev. Stat. 469A.010, in effect at the time of execution of this Agreement. RPS Attributes do not include Environmental Attributes that are greenhouse gas offsets from methane capture not associated with the generation of electricity and not needed to ensure that there are zero net emissions associated with the generation of electricity.

Definition of Environmental Attributes

As used in this schedule, Environmental Attributes shall mean any and all claims, credits, benefits, emissions reductions, offsets, and allowances, howsoever entitled, resulting from the avoidance of the emission of any gas, chemical, or other substance to the air, soil or water. Environmental Attributes include but are not limited to: (1) any avoided emissions of pollutants to the air, soil, or water such as (subject to the foregoing) sulfur oxides (SOx), nitrogen oxides (NOx), carbon monoxide (CO), and other pollutants; and (2) any avoided emissions of carbon dioxide (CO2), methane (CH4), and other greenhouse gases (GHGs) that have been determined by the United Nations Intergovernmental Panel on Climate Change to contribute to the actual or potential threat of altering the Earth's climate by trapping heat in the atmosphere.

Definition of Resource Sufficiency Period

This is the period from the current year through 2020.

Definition of Resource Deficiency Period

This is the period from 2021 through 2034.

Definition of Renewable Resource Sufficiency Period

This is the period from the current year through 2019.

Definition of Renewable Resource Deficiency Period

This is the period from 2020 through 2034.

Effective for service
on and after September 23, 2015

SCHEDULE 201 (Continued)

DISPUTE RESOLUTION

Upon request, the QF will provide the purchasing utility with documentation verifying the ownership, management and financial structure of the QF in reasonably sufficient detail to allow the utility to make an initial determination of whether or not the QF meets the above-described criteria for entitlement to pricing under the Standard PPA.

The QF may present disputes to the Commission for resolution using the following process:

The QF may file a complaint asking the Commission to adjudicate disputes regarding the formation of the standard contract. The QF may not file such a complaint during any 15-day period in which the utility has the obligation to respond, but must wait until the 15-day period has passed.

The utility may respond to the complaint within ten days of service.

The Commission will limit its review to the issues identified in the complaint and response, and utilize a process similar to the arbitration process adopted to facilitate the execution of interconnection agreements among telecommunications carriers. See OAR 860, Division 016. The administrative law judge will not act as an arbitrator.

SPECIAL CONDITIONS

1. Delivery of energy by Seller will be at a voltage, phase, frequency, and power factor as specified by the Company.
2. If the Seller also receives retail Electricity Service from the Company at the same location, any payments under this schedule will be credited to the Seller's retail Electricity Service bill. At the option of the Customer, any net credit over \$10.00 will be paid by check to the Customer.
3. Unless required by state or federal law, if the 1978 Public Utility Regulatory Policies Act (PURPA) is repealed, PPAs entered into pursuant to this schedule will not terminate prior to the Standard or Negotiated PPA's termination date.

TERM OF AGREEMENT

Not less than one year and not to exceed 20 years.

Effective for service
on and after September 23, 2015