



e-FILING REPORT COVER SHEET

Send completed Cover Sheet and the Report in an email addressed to: [PUC.FilingCenter@state.or.us](mailto:PUC.FilingCenter@state.or.us)

REPORT NAME: 2017 Smart Grid Report

COMPANY NAME: Idaho Power Company

DOES REPORT CONTAIN CONFIDENTIAL INFORMATION? No Yes

If yes, please submit only the cover letter electronically. Submit confidential information as directed in OAR 860-001-0070 or the terms of an applicable protective order.

If known, please select designation: RE (Electric) RG (Gas) RW (Water) RO (Other)

Report is required by: OAR  
Statute  
Order 12-158 and 17-076  
Other

Is this report associated with a specific docket/case? No Yes

If yes, enter docket number: UM 1460 and UM 1675

List applicable Key Words for this report to facilitate electronic search:

**DO NOT electronically file with the PUC Filing Center:**

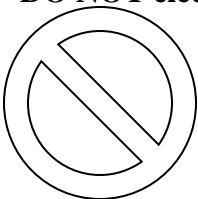

- Annual Fee Statement form and payment remittance or
- OUS or RSPF Surcharge form or surcharge remittance or
- Any other Telecommunications Reporting or
- Any daily safety or safety incident reports or
- Accident reports required by ORS 654.715

**Please file the above reports according to their individual instructions.**

Lisa D. Nordstrom  
Lead Counsel  
[lnordstrom@idahopower.com](mailto:lnordstrom@idahopower.com)

September 29, 2017

Public Utility Commission of Oregon  
Filing Center  
201 High Street SE, Suite 100  
P.O. Box 1088  
Salem, Oregon 97301

RE: UM 1675 - Idaho Power Company's 2017 Smart Grid Report

Attention Filing Center:

Idaho Power Company submits for filing its *2017 Smart Grid Report* in compliance with Order No. 12-158 in Docket No. UM 1460 and Order No. 17-076 in UM 1675. Per the Filing Center's request last year, 10 copies of the bound report will be sent via U.S. Mail. The Smart Grid Report includes the following documents:

- Appendix A Stakeholder Input
- Appendix B Peak Reliability Project Plan
- Appendix C Smart Grid Metrics
- Appendix D Final Observability Report
- Appendix E Quarterly Peak Reliability Synchrophasor Program Project Status Reports

Please address all data requests and other communication to:

Electronic: [lnordstrom@idahopower.com](mailto:lnordstrom@idahopower.com)  
[dockets@idahopower.com](mailto:dockets@idahopower.com)

Regular Mail: Lisa Nordstrom  
Idaho Power Company  
1221 W. Idaho Street  
Boise, Idaho 83702

Informal substantive questions concerning this filing may be directed to Regulatory Analyst Kristy Patteson at 208-388-2982 or [kpatteson@idahopower.com](mailto:kpatteson@idahopower.com).

Sincerely,



Lisa D. Nordstrom

LDN:kkt

Enclosures

cc: Service List – UM 1675  
Service List – UM 1460  
Service List – LC 68  
Service List – UE 233

# SMARTgrid Report

September 29, 2017





## TABLE OF CONTENTS

Table of Contents .....	i
List of Tables .....	iii
List of Figures .....	iv
List of Appendices .....	iv
List of Acronyms .....	v
Executive Summary .....	1
Solicitation of Stakeholder Input .....	2
I. Smart Grid Goals, Objectives, Strategy, and Process.....	3
A. Goals and Objectives .....	3
The Smart Grid is Customer Centered.....	3
Smart Grid is Data Rich.....	3
Edge of Network.....	3
B. Strategy .....	4
Operations.....	4
Customer Systems.....	5
C. Process .....	5
II. Status of Smart Grid Investments.....	5
A. Transmission Network and Operations Enhancements .....	5
Transmission Situational Awareness—Grid Operator’s Voltage Stability Monitoring and Control Assistant.....	5
Dynamic Line Rating Pilot .....	7
Power System Engineering Research Center.....	7
B. Substation and Distribution Network and Operations Enhancements .....	12
Solar End-of-Feeder Project .....	12
Volt/VAr InterTechnology Control Pilot.....	14
Electric Vehicle Activities .....	17
Replace the Existing Outage Management System .....	18

Automated Connect/Disconnect Capability.....18

Implement Additional AMI Outage Scoping and Restoration Confirmation  
Functionality .....18

C. Customer Information and Demand-Side Management Enhancements.....19

    myAccount.....19

    Customer Relationship Management .....20

    Direct Load Control .....21

D. Distributed Resource and Renewable Resource Enhancements .....21

    Renewable Integration Tool—Current Project Developments .....21

E. General Business Enhancements .....22

    The Mobile Workforce Management System Upgrade .....22

III. Future Smart Grid Investments .....22

    A. Transmission Network and Operations Enhancements .....22

    B. Substation and Distribution Network and Operations Enhancements .....22

        700-MHz Field Area Network .....22

        Integrated Volt-VAr Control (IVVC) System Phase 1 Project (formerly known as  
Automated Volt/VAr Management) .....23

        Jordan Valley Energy Storage Project .....25

        Substation Fiber-Based Protection and Control Pilot .....26

    C. Customer Information and Demand-Side Management Enhancements .....26

        Ice-Based Thermal Energy Storage .....26

IV. Smart Grid Opportunities and Constraints .....27

    A. Transmission, Substation, Operations, and Customer Information Enhancements.....27

        Personalized Customer Interaction .....27

    B. Evaluations and Assessments of Smart Grid Technologies.....28

        Solar Forecasting Tool Development .....28

        Phased Implementation of Distribution Circuit Fault Locating.....28

    C. Smart Grid Pilots and Programs .....29

    D. State of Key Technologies .....29

V. Targeted Evaluations.....	30
Recommendation No. 1 .....	30
Recommendation No. 2 .....	30
Recommendation No. 3 .....	30
Recommendation No. 4 .....	31
Recommendation No. 5 .....	31
Recommendation No. 6 .....	32
VI. Related Activities.....	33
A. Cyber and Physical Security .....	33
Timing Intrusion Management Ensuring Resiliency Project.....	33
B. Privacy .....	34
C. General Customer Outreach and Education.....	35
Communications .....	36
VII. Conclusion.....	36

## LIST OF TABLES

### Table 1

Low-voltage statistics from April 23, 2016, to August 12, 2017. Low-voltage count includes how many 1-minute voltage reads were recorded less than 114 V. Percent low voltage is the percentage of total voltage reads that were less than 114 V. Data: 1-minute average voltage measurements from smart grid monitor during summer 2016 and 2017.....12

### Table 2

Circuit summary.....15

### Table 3

Preliminary results .....

### Table 4

Preliminary change in losses.....16

### Table 5

Preliminary results of analysis .....

## LIST OF FIGURES

<b>Figure 1</b>	
Solar installation as part of the Solar End-of-Feeder Project.....	12
<b>Figure 2</b>	
Voltage duration curve for summer 2016 and 2017. Data: 1-minute average voltage measurements from smart grid monitor during summer 2016 and 2017 (322,562 voltage measurements). .....	13
<b>Figure 3</b>	
Low-voltage occurrences plotted by time of day. Data: 1-minute average voltage measurements from smart grid monitor during summer 2016 and 2017.....	13
<b>Figure 4</b>	
Idaho Power updated website and myAccount .....	20

## LIST OF APPENDICES

Appendix A. Stakeholder input.....	37
Appendix B. Peak Reliability Project Plan .....	43
Appendix C. Smart Grid Metrics .....	57
Appendix D. Final Observability Report .....	83
Appendix E. Quarterly Peak Reliability Synchrophasor Program (PRSP) Project Status Reports .....	153



## LIST OF ACRONYMS

A/C—Air Conditioning  
ACC—Automated Capacitor Control  
AMI—Advanced Metering Infrastructure  
ANSI—American National Standards Institute  
CR&B—Customer Relationship and Billing  
CRM—Customer Relationship Management  
DC—Direct Current  
DOE—U.S. Department of Energy  
DSM—Demand-Side Management  
EIM—Energy Imbalance Market  
ESS—Energy Storage System  
EV—Electric Vehicle  
FAN—Field Area Network  
FIDVR—Fault-Induced Delayed Voltage Recovery  
GWh—Gigawatt-Hours  
IED—Intelligent Electronic Devices  
IEEE—Institute of Electrical and Electronics Engineers  
INL—Idaho National Lab  
IRP—Integrated Resource Plan  
IT—Information Technology  
IVVC— Integrated Volt-VAr Control  
kV—Kilovolt  
kW—Kilowatt  
kWh—Kilowatt-hour  
LSE—Linear State Estimator  
LTC—Load Tap Changer  
MHz—Megahertz  
MWh—Megawatt-Hour  
MVA—Megavolt Ampere  
O&M—Operation & Maintenance  
OAR—Oregon Administrative Rule  
OLTC—On-Load Tap Changers  
OMS—Outage Management System  
OPF-LI—Optimal Power Flow-Loading Limit  
OPUC—Public Utility Commission of Oregon  
ORS—Oregon Revised Statute  
PDC—Phasor Data Concentrator  
PMU—Phasor Measurement Unit  
PNNL—Pacific Northwest National Laboratories

PPA—PMU Performance Analyzer  
PRSP—Peak Reliability Synchrophasor Program  
PV—Photovoltaic  
QoS—Quality of Service  
RAS—Remedial Action Scheme  
RIT—Renewable Integration Tool  
ROSE—Region of Stability Existence  
SCADA—Supervisory Control and Data Acquisition  
SE—State Estimator  
SGIG—Smart Grid Investment Grant  
SGM—Smart Grid Monitoring  
SVIR—Sun Valley Institute for Resiliency  
TE—Transportation Electrification  
TES—Thermal Energy Storage  
TOD—Time of Day  
TSS—Test Suite Specification  
VAr—Volt Ampere Reactive  
VSAI—Voltage Stability Assessment Index  
VVMS—Automated Volt/VAr Management System

## EXECUTIVE SUMMARY

Idaho Power Company (Idaho Power or the company) is pleased to present its *2017 Smart Grid Report* in compliance with Order No. 12-158 issued by the Public Utility Commission of Oregon (OPUC) in Docket UM 1460. The OPUC's smart grid goal and objectives as set forth in this order are as follows:

*The Commission's goal is to benefit ratepayers of Oregon investor-owned utilities by fostering utility investments in real-time sensing, communication, control, and other smart-grid measures that are cost-effective to consumers and that achieve the following:*

- *Enhance the reliability, safety, security, quality, and efficiency of the transmission and distribution network*
- *Enhance the ability to save energy and reduce peak demand*
- *Enhance customer service and lower cost of utility operations*
- *Enhance the ability to develop renewable resources and distributed generation.*

This document presents Idaho Power's fifth annual smart grid report and describes the company's efforts toward accomplishing the OPUC's goals. This report explains the company's overall strategies, goals, and objectives as they pertain to its smart grid efforts. It provides a review of current smart grid projects, initiatives, and activities being performed by the company and describes additional projects the company plans to undertake in the next five years. Opportunities the company has identified, as well as potential constraints, are also discussed.

Idaho Power evaluates new smart grid technologies and opportunities in a process to determine if they solve an existing problem, improve efficiency, increase reliability, improve safety or security, or enhance customer satisfaction. Opportunities for funding smart grid projects are evaluated using common criteria alongside other capital projects being considered by the company.

The OPUC's specific recommendations for this report included in Order No. 17-076, Docket UM 1675, are presented in Section V. Targeted Evaluations.

## SOLICITATION OF STAKEHOLDER INPUT

In preparation for filing this report, Idaho Power provides the public and other parties an opportunity to contribute information and ideas on smart grid investments and applications.

To solicit input from the general public, Idaho Power completed a draft report and made it available for review by the public and other stakeholders for a specific period. The company placed an advertisement—Share Your Ideas About Smart Grid—in the two newspapers with the best coverage in Idaho Power’s Oregon service area, the *Argus Observer* (Ontario) and the *Hells Canyon Journal* (Halfway). Idaho Power included a web link in the newspaper ads that directed readers to a copy of the draft smart grid report.

Idaho Power also sent an email soliciting comments to all parties on the service lists of the initial smart grid docket, UM 1460; Idaho Power’s last Oregon general rate case docket, UE 233; Idaho Power’s last integrated resource planning docket, LC 68; and Idaho Power’s 2016 smart grid report docket, UM 1675. Idaho Power requested comments be submitted by August 25, 2017.

Copies of the newspaper advertisements and the email solicitation are provided in Appendix A. Also included is a screenshot of the smart grid landing page from Idaho Power’s website. Idaho Power did not receive informal comments from any parties on the 2017 draft report; therefore, no informal comments are included in the appendix.

# I. SMART GRID GOALS, OBJECTIVES, STRATEGY, AND PROCESS

The smart grid is a concept whereby utilities deploy new technologies to reduce costs and improve the operation of the electrical power system. Idaho Power continues to evaluate new technological advancements and adopt these technologies as appropriate.

This document represents a vision of technology Idaho Power may deploy in the near to mid-term future. It presents various projects and programs Idaho Power is undertaking or may undertake. Some of the projects are already underway, while others are for future consideration. The *2017 Smart Grid Report* is a vision paper supported with concrete studies and analyses created by a working group of Idaho Power senior managers and their staff. The vision represented herein is forward looking and may be adjusted as years progress.

## A. Goals and Objectives

### ***The Smart Grid is Customer Centered***

The smart grid concept provides customers easier access to their energy-use information and empowers them to act on that information. It provides information to customers and allows them to be more involved and proactive in managing their energy use. Idaho Power believes customers expect utilities to provide a different experience than the traditional paradigm of service. In part, this paradigm change is driven by the increasing use of technology in our everyday lives. Customers are likely to seek an interactive experience that enables them to make choices in their energy use.

### ***Smart Grid is Data Rich***

The smart grid is a data-rich environment with embedded sensing devices located throughout the electric system. These devices automate control and processes while providing information needed to more efficiently operate the system. It provides two-way flows of information between devices and Idaho Power and its customers. It gives the utility the ability to more efficiently integrate distributed resources. It provides resiliency in utility response to outages, speeding up restoration efforts.

### ***Edge of Network***

The smart grid is moving to the edge of the network—an area where utilities have traditionally not gone. This edge goes all the way to the secondary side of the service transformer and even down to the meters of the homes and businesses served by Idaho Power. The ability to control power quality at the customer level enables the system to become more efficient and responsive to customer needs while maintaining customer privacy.

The smart grid represents an opportunity to enhance the value customers receive from the electric system. Idaho Power is committed to helping customers realize this value through good planning and wise investments, considering both costs and benefits associated with any smart grid project. Idaho Power must maintain the safety and reliability expected of it by both

customers and employees while implementing this vision. By optimizing and modernizing the power system, Idaho Power can enhance customer service, improve power reliability, promote energy efficiency, and more efficiently integrate renewable resources.

At Idaho Power, the smart grid vision consists of seven major characteristics:

1. Enhance customer participation and satisfaction
2. Accommodate generation/energy storage
3. Enable new products/services/markets
4. Improve power quality
5. Optimize asset efficiency
6. Anticipate and respond to disturbances
7. Provide resilient operation/robustness

## **B. Strategy**

The company's strategy for realizing the smart grid vision focuses investments in the following areas:

### ***Operations***

Idaho Power plans to invest in real-time sensing, diagnostic, communications, and control equipment to increase the efficiency and reliability of the system. Simultaneous with these investments, Idaho Power must meld together planning activities, field work, and operations to integrate new operations tools with existing tools that are familiar to system operators.

The company has determined a strategy for communicating with the many devices already installed on the electrical system and new devices to be installed in the future. While Idaho Power has operated several communication systems for many years, many of the systems are becoming outdated or have reached capacity. With the purchase of a band of 700-megahertz (MHz) communication spectrum, Idaho Power is in the process of deploying a field area network (FAN) that can provide high-speed communications with considerable bandwidth for communicating with devices in the field.

Idaho Power plans to undertake specific operational projects described more fully later in this report, including the following:

- Install a transmission line situational awareness tool.
- Pilot a new integrated volt-VAr control (IVVC) system.
- Install a 700-MHz FAN.

- Install an energy storage system at a substation.
- Plan for the phased implementation of distribution circuit fault locating.

### ***Customer Systems***

Idaho Power believes customers' expectations are changing, and they want more timely information about their energy use. To provide customers easier access to information about their energy use and enable them to take actions based on that information, many activities must occur.

One specific customer systems project planned for implementation and described later in this report is the development of the Customer Relationship Management (CRM) system.

## **C. Process**

The Transmission and Distribution Strategies department is the primary department responsible for assessing new grid technologies, including smart grid opportunities. This department is responsible for tracking and evaluating industry technologies, guiding technology pilots, and assessing pilot-project outcomes.

Plans for utility-wide deployment of successful technologies are submitted for capital funding and evaluated with all other capital-funding requests.

## **II. STATUS OF SMART GRID INVESTMENTS**

The following sections describe the smart grid projects, initiatives, and activities underway and the results to date.

### **A. Transmission Network and Operations Enhancements**

#### ***Transmission Situational Awareness—Grid Operator's Voltage Stability Monitoring and Control Assistant***

Idaho Power system operators rely on a day-ahead power flow analysis and real-time analysis tools to manage the grid.

The goal of this project is to develop an application that enhances grid reliability by improving the quality and use of the synchrophasor data received from nearly 600 western interconnection phasor measurement units (PMU).

Idaho Power, Southern California Edison, Peak Reliability, California Independent System Operator, Bonneville Power Administration, San Diego Gas and Electric, and V&R Energy have received a U.S. Department of Energy (DOE) research and demonstration grant for a new synchrophasor-based software application named the Grid Operator's Monitoring & Control Assistant. The funding matches dollars committed by the seven participants to extend and deploy synchrophasor technologies. Peak Reliability will use the grant to improve the quality and use of

the synchrophasor data it receives from the PMUs referenced above. See Appendix B for Peak Reliability's project plan.

The proposed software application consists of the following major components:

1. Use of a linear state estimator (LSE) for the following purposes:
  - Estimating the state of the observable system using a direct, non-iterative solution based on PMU measurements of voltage and current.
  - Validating the results of a conventional model-based state estimator (SE) for the observable system.
  - Potentially replacing the conventional SE solution if it becomes temporarily unavailable. This will only be achievable when enough PMUs are installed across the system to make it fully observable.
  - Using cases created by the LSE for voltage stability analysis, once the system is fully observable.
2. Voltage stability analysis software ROSE (Region of Stability Existence)—A real-time analysis tool that increases situational awareness of the operators, allowing for the accurate and timely prediction of steady-state voltage instability.
3. An off-line version of ROSE—This allows Idaho Power system planners to troubleshoot and develop scenarios to be used in the real-time version that may change based on seasonal conditions.
4. Computation of phase-angle difference limits in real time—Provide easy-to-understand visualization of synchrophasor data and voltage stability analysis results. V&R Energy will perform a demonstration of the software tool. Idaho Power will prepare and provide data to V&R Energy, respond to the data-related questions, review and provide feedback on the functionalities of the tool, test the software tool, and receive training on the software application.

The Grid Operator's Monitoring & Control Assistant software will validate the SE and provide operator visualization of synchrophasor data. The software provides visibility between snapshots of the SE and reduced visibility (at least until enough PMU installations are in place), as well as during critical times when the SE solution is unavailable. The overall goal of the project is to improve grid reliability.

The beta version of the Grid Operator's Monitoring & Control Assistant has been installed on Idaho Power's System Planning computers for evaluation. This beta version does not include the LSE but does include a near real-time analysis program (ROSE), as well as an event analysis program (ROSE off-line) to allow planners to review past events. The near real-time beta version acquires an SE solution from the peak reliability coordinator every five minutes and computes selected path limits to voltage collapse for pre-determined stressing scenarios.



## ***Dynamic Line Rating Pilot***

As originally described in the *2014 Smart Grid Report*, Idaho Power and the Idaho National Laboratory (INL) continue to collaborate on a system that predicts wind speed and direction along a transmission line from an area-specific wind model using real-time weather station information located along the same transmission line. The software program being developed by the INL calculates the actual line limits based on the measured ambient conditions and wind model results. A pilot system with 15 weather stations was installed in a test area monitoring a portion of the 230-kilovolt (kV) and 138-kV transmission lines between Hagerman, Bliss, and Glens Ferry, Idaho. The original pilot system was expanded to include 46 weather stations covering the entire line corridor from the Midpoint Substation north of Twin Falls to the Boise Bench Substation in Boise, Idaho. The original pilot system weather stations have been upgraded, and the additional weather stations were installed during 2016.

The INL is continuing to update the software to calculate operating line limits, with the final product expected to be available to Idaho Power's Grid Operations group later in 2017. The company will have real-time line-limit capacity calculations for the lines in this project available via Idaho Power's enterprise infrastructure management and monitoring system database, with historical values for review and demonstration by Idaho Power's Planning and Engineering and Operations departments. Idaho Power and the INL continue to gather data to assess the potential to dynamically rate transmission line operating limits in the Hells Canyon area along the Oregon–Idaho border, with six weather stations currently installed. Idaho Power is working to install a seventh weather station at the Hells Canyon Power Plant. Data gathering is expected to continue through the first half of 2017 and will be assessed later this year. Due to the extreme topology of the Hells Canyon area, the installation and data gathering is proving to be a challenging endeavor. Idaho Power and the INL continue to work closely together to further this technology and approach.

## ***Power System Engineering Research Center***

Idaho Power currently participates in the Power System Engineering Research Center (PSERC)—an Industry-University cooperative, drawing on university capabilities to creatively address challenges facing the electric power industry. It conducts research for innovative solutions to these challenges using multidisciplinary research expertise in a multi-campus work environment and facilitates the interchange of ideas and collaboration among academia, industry, and government, which also helps educate the next generation of power system engineers.

Idaho Power is tracking the following projects and will evaluate Idaho Power specific initiatives based on these projects' findings.

### **(T-57HI) Life-Cycle Management of Mission-Critical Systems through Certification, Commissioning, In-Service Maintenance, Remote Testing, and Risk Assessment**

This project addresses the criteria for robust and reliable operation and offers solutions in terms of both the methodology and practical tools to perform required testing and evaluation. The outcome of the project will be delivery of several testing and evaluation tools: testing and certification lab, testing and certification equipment and protocols, calibration and field-testing equipment for in-service maintenance, software tools to enable remote testing and detection of

failures, and visualization tools that are able to track the quality of service (QoS) state of critical systems and inform operators about deterioration modes. This is the third and final year of the project. Industry participants will host field implementation and demonstration of the tools. This will include the following:

1. Setting up a PMU testing lab to ensure compliance with Institute of Electrical and Electronics Engineers (IEEE) Test Suite Specification (TSS).
2. Testing local PMUs using PMU Performance Analyzer (PPA) for pre-specified scenarios.
3. Setting up middleware, Erkios, for remote end-to-end testing of mission critical systems.
4. Integrating remote testing of PMUs using PPA with the ERKIOS platform.
5. Integrating ERKIOS into remote testing of single or multiple substation Remedial Action Schemes (RAS).
6. Testing PMU devices and intelligent electronic devices (IED) with synchrophasor capabilities in the calibration laboratory to check their compliance with the latest IEEE C37.118.1a-2014 standard, and issuing the IEEE Conformity Assessment Program (ICAP) certificate if complied with the IEEE standards.
7. Troubleshooting testing of the end-to-end synchrophasor system in the field. This includes a field calibrator device used to interact with the synchrophasor system devices, execute the set of tests, and create a report after analyzing the acquired data sets. The calibrator should be able to 1) generate two main types of signals for two types of tests (namely, the type tests and application tests); 2) receive the stream of data from any PMU or phasor data concentrator (PDC) and parse the information; and 3) perform various analytics to troubleshoot the performance of the synchrophasor system elements (timing source, PMU, communication gear, PDC).
8. Conducting periodic maintenance testing of PMU accuracy using Gold PMU. A Gold PMU is designed as a high-accuracy PMU device used in a field environment (e.g., a field end-to-end calibrator). In this configuration, Gold PMU serves as the synchrophasor reference, whose output values are compared with PMU measurements to evaluate PMU performance. Because the input signal may or may not be known, Gold PMU measurements are used as a reference irrespective of what the input signal might be.
9. Application testing of synchrophasor system using a fault locator. Once the lab and field tests are performed, to deploy life-cycle management tool in end-to end testing of the system, application testing is required. Fault location as an application testing use case allows the operator to verify the application testing procedure with the available report of the actual incidence.
10. Visualizing and analyzing PMU information with error detection: An overall goal of PMUs is improved situational awareness. This needs achieved even in situations in

which the PMUs may have errors. The purpose of this use case is to show how PMU data can be used to improve situational awareness in operations and how a variety of errors can be detected.

### **(S-70) Leveraging Conservation Voltage Reduction for Energy Efficiency, Demand-Side Control, and Voltage Stability Enhancement in Integrated Transmission and Distribution Systems**

A new algorithm based on load modeling is developed to assess real-time real/reactive load-reduction effects of conservation voltage reduction (CVR). A co-simulation framework for transmission and distribution systems is proposed to investigate the impacts of CVR on voltage stability margins of transmission systems. The coordination between energy-oriented and stability-oriented CVR will be studied. The mutual impacts between voltage reduction and voltage control of distributed generation will also be investigated.

This project is to develop a comprehensive framework that assesses the energy-saving, demand-reduction, and stability-enhancement potential of CVR. The current work progress is summarized as follows:

- Development of integrated transmission and distribution co-simulation framework by means of providing an interface between transmission and distribution simulators that will be capable of handling co-simulation effectively. Efforts are in progress to build the co-simulation framework with PSS@E and GridLAB-D for validation of the findings on the transmission network with aggregated distribution system. The distribution system power flow with CVR was extended to be included in the transmission network to study the impact of CVR on the transmission system voltage stability margin (VSM). Preliminary results are available with aggregated distribution system modeled as ZIP load. ZIP are the coefficients of a load model comprised of constant impedance, constant current, and constant power loads. “Z” stands for constant impedance load, “I” stands for constant current load, and “P” stands for constant power load. A ZIP coefficient load model is used to represent power consumed by a load as a function of voltage.
- Development of a framework in which CVR is applied to improve voltage stability. In this framework, a two-stage optimization is used to determine the set point of voltage controllers.
- Assessment of performance and control of inverters as one the fast-response voltage control actuators. In this area, researches have been focused on two topics: 1) investigating the effects of system transients on the design of smart inverter control for distribution system voltage regulation, and 2) studying the fundamental performance limits of inverter-based voltage control depending on the communication network topology. Numerical studies have been performed on the first topic, studying the choice of droop control slope based on how fast the input dynamics evolves. As well, some theoretical results to characterize the best solutions for given communication topology have been obtained.

### **(S-64) Monitoring and Maintaining Limits of Area Transfers with PMUs**

This project will develop practical methods based on PMUs to detect and act on conditions in which the transfer of power through areas of the power system should be curtailed to satisfy thermal line limits and small-signal stability limits. Closed-loop controls for robust stability will also be developed. The larger objective is to combine measurements with physical network models to turn PMU data into actionable advice for operators to improve the management of bulk power transfers and control instabilities. Implementation of this project is subject to additional funding to support this work.

Work continues toward making the area angle measured by PMUs around the border of the area more practical:

1. How detailed should the underlying direct current (DC) load flow model of the area being monitored be to get good results?
2. How do the results (setting alarm thresholds for operation actions) depend on the pattern of stress the area is experiencing?
3. Can we set up area angle monitoring for areas with more complicated patterns of flow?
4. Determine best locations for placing synchrophasors so voltage instability is determined.
5. Continue to test models of three power system areas for area angle monitoring. These include Washington and Oregon states with N-S transfers, the Idaho Power system with E-W transfers, and the Southern California Edison system with transfer into load bus in the center of the area.

### **(S-65) Real-Time Synchrophasor Measurements-Based Voltage Stability Monitoring and Control**

This project will attempt to improve the situational awareness of the power grid by assessing the short-term and long-term voltage stability in real time using synchrophasor measurements. These methods have been validated on standard IEEE test cases, and their performance on a real system (~10,000 buses) will be studied. The analysis will provide insights on the effective locations for short-term monitoring and efficient control strategies. The long-term voltage stability assessment using a reduced local network for a given, limited number of PMUs will be developed. These algorithms will be integrated and implemented in a real-time test environment for validation and to anticipate issues in actual implementation.

This project is finished, and a final report has been issued. This information will be used in evaluating whether to pursue an implementation in our system of some of the control strategies discussed in the report. The final report will not be available to the public until 2018, and it will be posted at [pserc.wisc.edu/research/public\\_reports.aspx](http://pserc.wisc.edu/research/public_reports.aspx). A short description of the results are as follows.

### ***Part I: Real-Time Synchrophasor Measurements Based on Short-Term Voltage Stability Monitoring and Control***

An important type of voltage instability is the short-term, large-disturbance voltage instability caused by increasing penetration of the induction motor and electronic loads.

- The problem of monitoring and mitigating fault-induced delayed voltage recovery (FIDVR) is addressed by utilizing the high sampling rate of PMUs and understanding the physics underlying the FIDVR problem to issue control signals to smart thermostats and shunt devices in real time.
- The only control schemes that can mitigate FIDVR are shown to be the tripping of air conditioners or the injection of reactive power via shunt devices.
- Using PMU measurements and a few off-line simulations will enable the utilities to detect FIDVR phenomenon and estimate the time to recover from FIDVR in less than three seconds. This capability, combined with air conditioner control via smart thermostats, can ensure the FIDVR recovery meets the transient voltage criteria set by reliability coordinators.

### ***Part II: Real-Time Synchrophasor Measurements Based on Long-Term Voltage Stability Monitoring and Control***

With the increasing scale and complexity, power systems are being operated closer to voltage stability limits. The main objective of the work in Part II is to develop a methodology for long-term voltage stability assessment using a reduced network given a limited number of phasor measurements.

- The Voltage Stability Assessment Index (VSAI) has been proposed in previous Washington State University work to calculate voltage stability indices at a load bus. Based on the work of VSAI, this project proposes an extension, called VSAI-II, that incorporates voltage dynamic mechanisms. The model improves the accuracy of the voltage stability index.
- The results show VSAI-II can not only provide the indices for the overall system but also the critical locations for voltage stability.
- A major load center is usually supplied by multiple generation and transmission facilities through several boundary buses. To investigate the voltage stability of a load center, a new method, optimal power flow-loading limit (OPF-LI), is developed to extend the voltage stability index based on an enhanced model of the generation and transmission systems. The results of OPF-LI are good approximations of the loading margin.
- Based on the dynamic mechanisms of on-load tap changers (OLTC), an OLTC blocking control is proposed. The OLTC blocking control can prevent the critical buses from entering unstable operating states.

## B. Substation and Distribution Network and Operations Enhancements

### *Solar End-of-Feeder Project*



**Figure 1**  
Solar installation as part of the Solar End-of-Feeder Project

The Solar End-of-Feeder Project is installed and is in operation. So far, the project has operated as expected, with the voltages maintained within American National Standards Institute (ANSI) C84.1 standards.

Through the first year of operation, the project shows that in this instance, solar installed at the end of a distribution circuit may cost-effectively mitigate low voltage occurring during daylight hours. The photovoltaic (PV) pilot project will continue to be monitored to ensure safe operation, and voltage will be monitored to ensure it maintains (ANSI) C84.1 standards.

**Table 1**

Low-voltage statistics from April 23, 2016, to August 12, 2017. Low-voltage count includes how many 1-minute voltage reads were recorded less than 114 V. Percent low voltage is the percentage of total voltage reads that were less than 114 V. Data: 1-minute average voltage measurements from smart grid monitor during summer 2016 and 2017.

	<b>2016</b>	<b>2017</b>
Low-Voltage Count	436	33
Percent Low Voltage	0.270%	0.020%
Minimum Voltage	111.80	112.68
Average Voltage	118.71	119.67

### 1-minute Average Voltage (23 April–12 August)

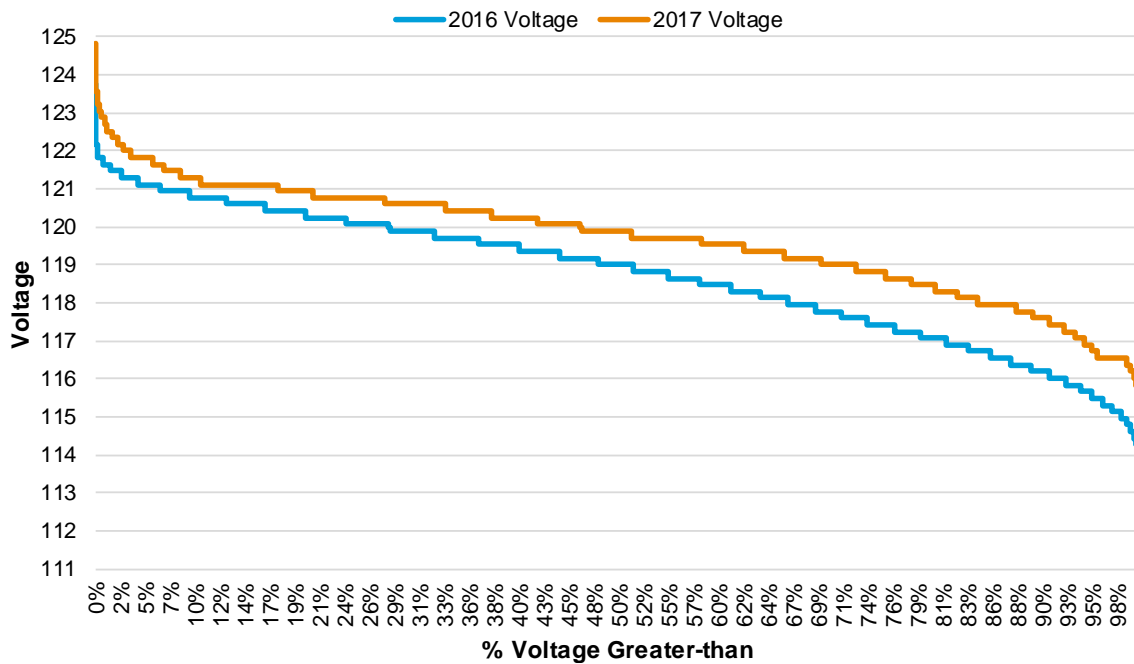

**Figure 2**  
Voltage duration curve for summer 2016 and 2017. Data:1-minute average voltage measurements from smart grid monitor during summer 2016 and 2017 (322,562 voltage measurements).

### Low-Voltage Measurements by Time of Day

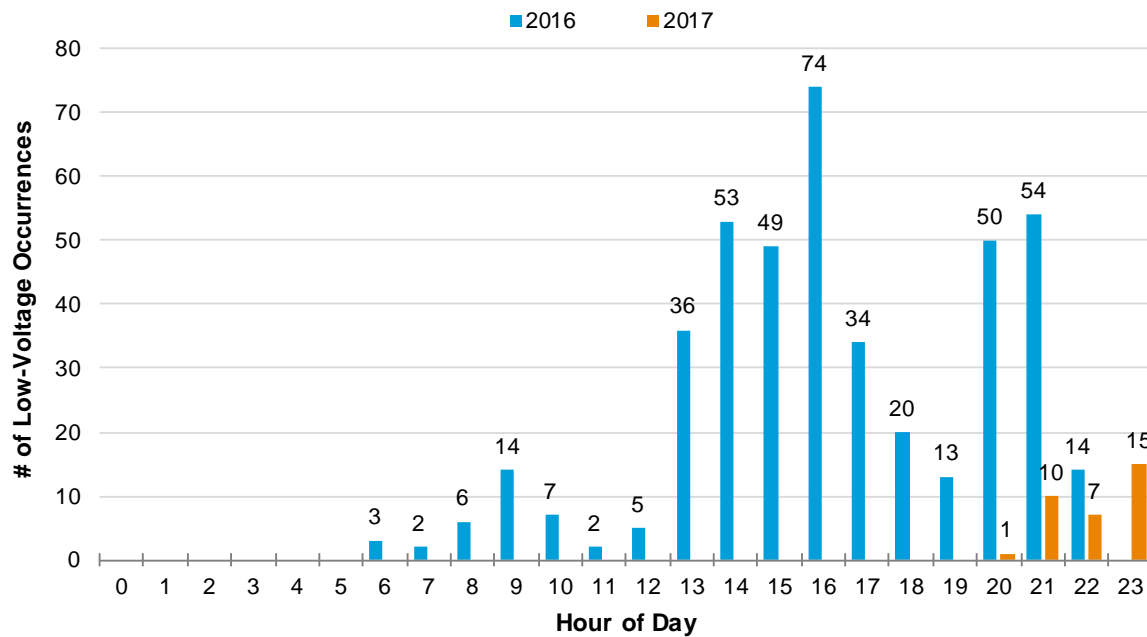

**Figure 3**  
Low-voltage occurrences plotted by time of day. Data:1-minute average voltage measurements from smart grid monitor during summer 2016 and 2017.

The final project size is 18 kilowatts (kW) instead of the planned 15 kW in the 2016 report. This is because the most competitive contractor for the project included three 6-kW inverters and commensurate-sized PV panels in their bid. While this is slightly larger than specified, the added size allows for greater flexibility.

### ***Volt/VAr InterTechnology Control Pilot***

Idaho Power initiated a 2016 project titled the InterTechnology Control Pilot as a lead up to the IVVC system (formerly the Volt/VAr Optimization) project. Through the InterTechnology Control Pilot, Idaho Power hopes to enhance its experience in controlling feeder voltages using substation transformer load tap changers (LTC), line voltage regulators, and line capacitors in a coordinated fashion and assist in determining the scope of the IVVC project, as well as the strategy and requirements associated with an IVVC system. This project can validate or invalidate the feasibility of applying various control strategies.

The scope of the Volt/VAr InterTechnology Control Pilot is to accomplish the following:

1. Determine a strategy or set of strategies that can be used for optimizing the Volt/VAr characteristics on a distribution circuit (i.e., flatten circuit voltage profile, improve VAr support for the transmission system, or other strategies).
2. Determine a strategy for coordinating the actions of LTCs, voltage regulators, and capacitors on a distribution circuit or set of circuits fed from one distribution transformer.
3. Install a small pilot project to test the identified strategies.
4. Make recommendations concerning individual devices to be used in a Volt/VAr optimization system.

The outcome of this project is a coordinated Volt/VAr management strategy involving two circuits. Intelligent line devices were installed on two circuits served out of Aiken Substation near Blackfoot, Idaho. The new capacitor bank controllers and voltage regulator controllers with two-way communications installed can be used for monitoring various line quantities, as well as send out signals to the line devices to change control set points. The new line capacitor banks will more evenly distribute the circuit's VAr support. Additionally, the substation LTC controller has been connected to the supervisory control and data acquisition system (SCADA) so control can be remotely performed.

An analysis was performed comparing pre-pilot values from the winter of 2015/2016 (December 15, 2015, to February 16, 2016) to post-pilot values from the winter of 2016/2017 (December 16, 2016, to February 17, 2017). Because Aiken is a summer-peaking substation, further analysis will be performed comparing 2016 summer data to 2017 results after the summer operating season is over.

A summary of the circuits where the pilot project was implemented is presented in Table 2.



**Table 2**  
Circuit summary

Circuit	Total Customers	Peak Load, Winter 2015–2016	Peak Load, Winter 2016–2017
AIKN-011	1,167	4.0 MW	4.4 MW
AIKN-013	205	5.1 MW	5.2 MW

Collected data includes the following:

- One-hour load data for each advanced metering infrastructure (AMI) customer connected at the AIKN substation
- One-hour load data for each MV90 (large industrial) customer connected to the AIKN substation
- One-hour average load data measured at the substation breaker for each circuit

### Loss Calculation

The losses of each circuit were determined by the following equation:

$$E_{loss} = E_{breaker} - E_{load}$$

Where:

$E_{loss}$  = Energy losses on the circuit at each hour

$E_{breaker}$  = Energy leaving the substation measured at the circuit breaker

$E_{load}$  = Total energy serving the load measured at the meter

The total energy loss during the three-month period was calculated by the following equation:

$$E_{loss-total} = \sum_{n=1}^n E_{loss}$$

### Preliminary Results

Table 3 shows the total energy and calculated losses for both circuits associated with the InterTechnology Control Pilot.

**Table 3**  
Preliminary results

Circuit		Total Energy (megawatt-hour [MWh])	Total Losses (MWh)	Percent Losses
AIKN-011	Pre-Pilot	5,252	318	6.1%
	Post-Pilot	5,752	323	5.6%
AIKN-013	Pre-Pilot	8,504	158	1.9%
	Post-Pilot	8,797	162	1.8%

The change in losses in each of the circuits is shown in Table 4.

**Table 4**  
Preliminary change in losses

Circuit	Pre-Project	Post-Project	Change
AIKN-011	6.056%	5.622%	- 7.166%
AIKN-013	1.905%	1.803%	- 5.350%

The preliminary data indicates a small reduction in technical losses for the circuits involved in the pilot, and it is surmised this reduction is due to circuit voltage flattening and more refined reactive power flow control. These are preliminary results and will be further refined after summer-season operating data is analyzed.

### LTC Operations

It was important the pilot's control regime not significantly increase the operation of the substation transformer LTC. Increased tapping operation can lead to additional wear on the LTC's electrical contacts, which can lead to premature LTC failure. Because LTCs are high value and difficult to replace, Idaho Power attempts to minimize LTC operations beyond those necessary to maintain adequate circuit voltages.

Idaho Power keeps monthly records of the total number of LTC operations for the transformer associated with the pilot. The number of LTC operations for the three-month period during the winter of 2015/2016 was compared with the same three-month period for the winter of 2016/2017. Table 5 shows the results of the preliminary analysis.

**Table 5**  
Preliminary results of analysis

	Pre-Project (Winter 2015–2016)	Post-Project (Winter 2016–2017)
Number of operations	625	464
% difference	–	-25.8%

The preliminary data indicates a significant reduction in LTC tap operations, which can be attributed to the flatter voltage profile on the circuits connected to the transformer. Because more voltage control was performed further out on the circuit, the LTC did not have to operate as often for voltage control.

Results to date show the InterTechnology Control Pilot provides improvement in circuit voltage and reactive power operating characteristics. Further analysis after the summer 2017 operating season will refine the results.

## ***Electric Vehicle Activities***

### **Home Electric Vehicle Charging Incentive Pilot**

The Sun Valley Institute for Resiliency (SVIR), located in Blaine County, Idaho, launched a bulk electric vehicle (EV) buy-down program named RevUp Blaine. SVIR negotiated significant vehicle discounts (up to \$7,000) from Nissan, BMW, and Chevrolet. Their goal is to recruit residents and businesses in Blaine County to purchase an EV.

In partnership with RevUp Blaine, Idaho Power is offering an additional customer incentive of \$300 toward the purchase and installation of a home Level 2 charging station. By offering this incentive, Idaho Power hopes to collect data on home charging infrastructure installation, costs and customer experience plus evaluate opportunities for program expansion. The incentive is limited to the first 30 participants, with an installation cutoff date of November 17, 2017.

### **EV Workplace Charging Station Incentive Program**

Idaho Power extended its 2016 EV Workplace Charging Station Incentive program into 2017. Business customers may apply for an incentive to offset the costs of installing EV charging stations for employees, fleet vehicles, or customers. Eligible customers may apply for an incentive for up to 50 percent of the project costs (equipment and labor) for installing one or more EV charging stations, up to a maximum of \$7,500 per company or municipality, per site. Charging stations must be installed by November 17, 2017, to be eligible for the incentive.

### **Oregon EV Awareness and Education Program**

As directed by Senate Bill 1547, the OPUC opened Docket AR 599 to establish a rulemaking regarding transportation electrification (TE) program applications. The goals of Senate Bill 1547 and Docket AR 599 are to accelerate TE to reduce petroleum use, achieve optimum levels of energy efficiency and carbon reduction, meet federal and state air-quality standards, meet Oregon's greenhouse gas emissions reduction goals described in Oregon Revised Statute (ORS) 468A.205, and improve public health and safety. As detailed in the AR 599 Rulemaking, Idaho Power was required to file an Application for a TE Program by December 31, 2016.

On December 30, 2016, Idaho Power filed an application, in Docket UM 1815, to implement an EV Awareness & Education Program in its Oregon service area. The program is intended to increase the awareness of EVs and educate customers on the potential benefits of EVs, including lower fuel costs, lower maintenance costs, little to no emissions, vehicle performance benefits, energy independence, and local economic benefits. The program will also help customers understand vehicle and charging technology and the available options. By providing awareness and education, Idaho Power will address key barriers to EV adoption within its Oregon service area, including driving range, price, charging, and other technical concerns. On July 27, 2017, the OPUC issued Order No. 17-286 approving the company's EV Awareness & Education Program and ordering Idaho Power to implement the program beginning in 2018 and ending in 2020.

Order No. 16-447 in Docket AR 599 directed the OPUC staff to open a separate docket to develop the requirements for electric utilities' long-term TE plans. An initial workshop regarding the requirements for utilities' TE plans was held on January 30, 2017. This matter is ongoing.

## ***Replace the Existing Outage Management System***

On January 14, 2017, Idaho Power commissioned a new Outage Management System (OMS). Idaho Power's previous OMS was aging and no longer supported by the original vendor. In 2010, Idaho Power began the effort to select a vendor and implement a new OMS. The project was progressing until early 2012, when critical Idaho Power resources assigned to the OMS project were needed to support the Customer Relationship and Billing (CR&B) project. In fall 2012, Idaho Power suspended the OMS project but reinitiated it in late 2014. The focus in 2015 was to select and contract with a vendor to provide the desired OMS capability. Idaho Power selected CGI's PragmaLine OMS and initiated the design phase of the project in August 2015; the design phase was completed in December 2015. Development and implementation phases began in January 2016 and were completed in January 2017.

The new OMS platform will aid in customer service restoration after power system interruption events. The OMS models the distribution, substations, and vital transmission elements used to provide energy to customers. The system also ties the local transformers, providing service to the customers being served. When a customer calls to report a power interruption, the OMS analyzes the circuit, referencing other customer calls when available, to predict the most probable device causing the interruption. Crews are then dispatched to the predicted device to investigate the cause of the outage and restore service. In addition, by integrating the OMS with Idaho Power's SCADA system, the OMS will show customer interruptions automatically when a SCADA device is opened. These devices are typically inside substations, such as circuit breakers or power circuit breakers. The new OMS will allow more efficient use of restoration crews, thereby increasing customer satisfaction and decreasing costs.

## ***Automated Connect/Disconnect Capability***

Idaho Power began remotely connecting services in eastern Oregon on August 16, 2016. The project to deploy automated connect/disconnect meters at sites with multiple historical connect/disconnect visits was concluded in 2016. Going forward, Idaho Power plans to install automated connect/disconnect meters to address access and safety issues, or to replace in-service meter failures. There are no plans at this time to deploy additional meters based on the number of connect/disconnect transactions.

Because it is currently unable to meet the requirements of Oregon Administrative Rule (OAR) 860-021-045(9)(b) due to system limitations, Idaho Power is using the remote connect functionality of the meters and only uses the remote disconnect functionality for customer requested disconnects.

## ***Implement Additional AMI Outage Scoping and Restoration Confirmation Functionality***

In 2013, Idaho Power tested AMI integration with the Smart Grid Monitoring (SGM) system, formerly known as the Sentry System, and found the systems can exchange sufficient data to provide Idaho Power's OMS with outage information related to event origination and tracking of outage restoration activity.

As part of Idaho Power's OMS replacement project, the company integrated the OMS and AMI systems, allowing the OMS operators to manually query AMI meters in the area of a sustained SGM outage event. The SGM system, used in conjunction with the OMS and AMI systems, will assist OMS operators in quickly and accurately locating outages on the distribution system and initiating outage restoration efforts without depending on customer calls.

The project integrates the OMS and AMI systems. Previously, "pinging" meters (call to the meter to verify it is energized) was performed through a separate tool, requiring the operator to compare separate systems while evaluating the meter's response. Enabling the operators to view the SGM call and initiate the AMI meter ping process, all from the OMS system, reduces operator intervention and data interpretation.

This work was included within the scope, cost, and schedule of the OMS replacement project and was functional when the OMS system was commissioned on January 14, 2017. The main benefit will be the initiation of outage restoration without depending on customer calls.

## **C. Customer Information and Demand-Side Management Enhancements**

### ***myAccount***

Idaho Power's website ([idahopower.com](http://idahopower.com)) had approximately 3.5 million visits in 2016. The myAccount customer portal within Idaho Power's website had approximately 2 million logins in 2016. The myAccount landing page is the gateway for customers to access their specific account and energy usage information. Once logged in, customers can view their bill, make payments, and initiate online account transactions and inquiries. Additionally, customers can access very detailed account and energy usage information, including their hourly energy usage data. The myAccount portal enables customers to make informed choices about their energy use and provides information on how to use energy wisely.

In March 2017, Idaho Power updated its main website landing page and main sections of myAccount to an adaptive/responsive web design. For customers, this new design has a consistent look and feel across any device used to access the website. Additionally, the new design improves navigation. Idaho Power's new web design is illustrated in Figure 4.

A central component of the myAccount landing page is the next-estimated-bill feature. A bar chart is displayed so customers can quickly compare their previous month's energy usage and billed amount to their current month's estimated bill, and compare the same month from the prior year. This graph gives customers a visual and insightful look at their current and historical energy use. The new landing page includes icon-driven navigation, helping customers access the account information that is most important to them, including detailed energy use.

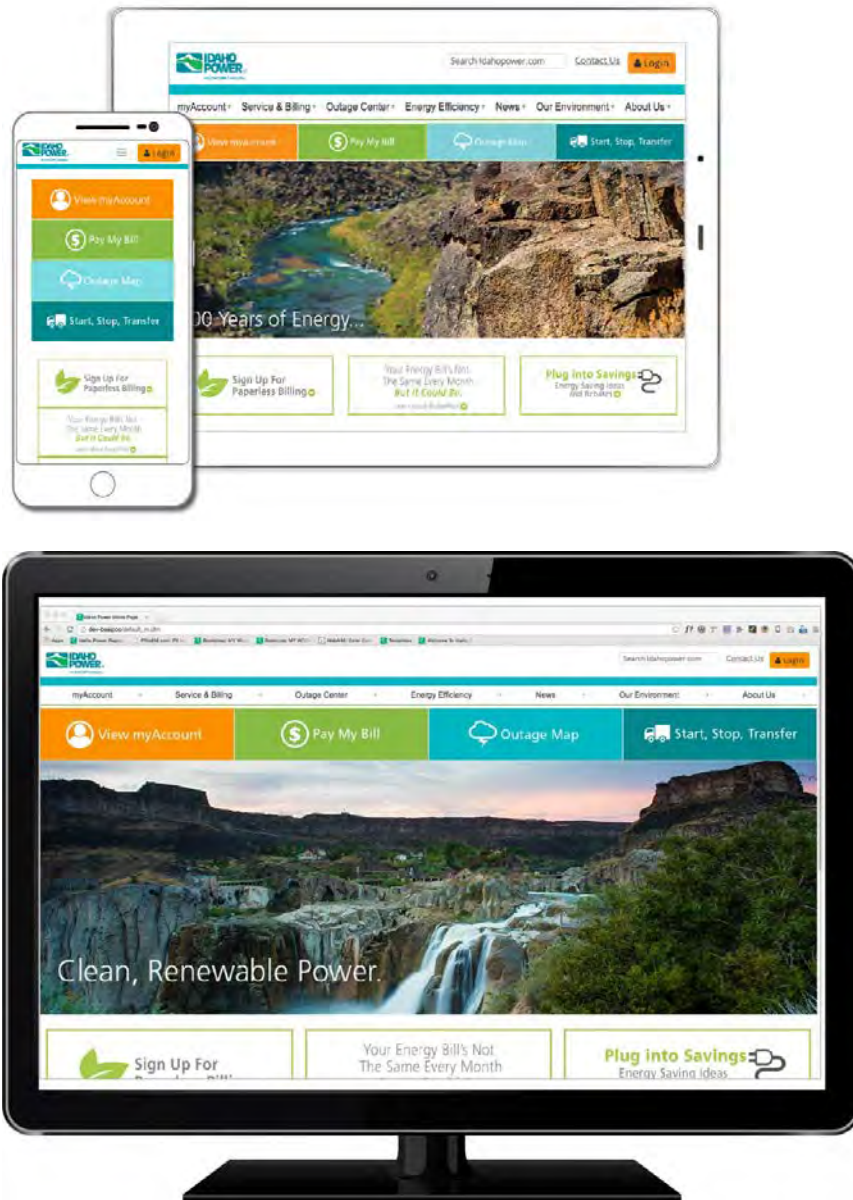

**Figure 4**  
Idaho Power updated website and myAccount

### ***Customer Relationship Management***

Idaho Power is seeking to enhance marketing applications; provide customers the ability to choose customer contact preferences; and expand customer communication methods, customer segmentation, and campaign management. Idaho Power is beginning to integrate the CRM system and expects full implementation by the first quarter of 2018.

The objective of incorporating a single CRM system, integrated with the CR&B system, is to allow Idaho Power to manage and track customer interactions related to energy efficiency and other customer relations activities with the ultimate goal of increasing the effectiveness of Idaho Power's program and service offerings.

Using the CRM capabilities of the CR&B system, the CRM application will retrieve data from a variety of data sources (meter usage data, customer data, demographics, program data, etc.). The software will provide the ability to query and report both formally and on an ad-hoc basis. Customer preference management (opt-out, marketing frequency, topic choice, etc.) will also be a component of the system.

The information can allow Idaho Power to better market its customer programs and service offerings. Systematically using various sources of data to reach customers should result in reduced printing and postage costs through more effective customer segmentation and targeted marketing. The information can aid the company in reaching customers more efficiently through the gradual shift to digital channels, such as email and text messages. Idaho Power anticipates these efforts will expand customer choice and satisfaction.

### ***Direct Load Control***

Idaho Power continues to operate the direct load control programs available to all its customer segments. There were no enhancement projects for the direct load control program during 2016 to 2017, and the company has no plans for future enhancements at this time.

## **D. Distributed Resource and Renewable Resource Enhancements**

### ***Renewable Integration Tool—Current Project Developments***

The Idaho Power Smart Grid Investment Grant (SGIG) helped fund the Renewable Integration Tool (RIT) project. The RIT project was intended to develop tools to allow grid operators to more efficiently and reliably integrate variable renewable resources with baseload generation resources.

In 2014, the RIT was split into two tools: the Wind Forecast Tool and the Load Forecast Tool. Both these tools are now operational and are benefitting grid operators by allowing the system operators to more closely match supply and demand. A more balanced system in preschedule and in real time helps ensure there is sufficient supply to meet demand, and less energy may need purchased in the real-time market.

The Wind Forecast Tool was recently updated to include 50 MW of new wind generation capacity. Further refinements to facilitate Idaho Power's participation in the Western Energy Imbalance Market (EIM) are in the development stage.

A second-generation Solar Forecast Tool was recently implemented. It incorporates improvements to the power forecast algorithm based on an analysis of operational solar park data and significantly improves the accuracy during morning and evening hours. A third-generation tool with further refinements, as well as support for Idaho Power's participation in the Western EIM, is in the planning stage.

A fully functional suite of RITs will allow grid operators to more efficiently and reliably integrate variable renewable resources with baseload generation resources. This will be further enhanced by Idaho Power's participation in the Western EIM.

## E. General Business Enhancements

### *The Mobile Workforce Management System Upgrade*

The mobile workforce management system upgrade went into production on January 14, 2017. Idaho Power has been using CGI's PragmaCad mobile workforce management system since 2007. This system is integrated with several other major systems necessary to provide automation and support for field service personnel. One of the major integrations is with the OMS system, which, as stated previously, was also replaced in 2017. The installation of the new OMS system and the PragmaCad upgrade were combined because both PragmaCad and PragmaLine (OMS) systems share common infrastructure. The latest release of PragmaCad has increased functionality that will improve the efficiency of field personnel and allow the company to maintain vendor support.

## III. FUTURE SMART GRID INVESTMENTS

This section describes smart grid investments Idaho Power is planning to undertake over the next five years (including pilots and testing). This section serves as a high-level strategic document for Idaho Power to plan its future smart grid projects. As such, the format of this section is different from the other sections in this report. The description for each of the following projects is laid out in the following format:

1. **Present:** What Idaho Power's present system looks like regarding the project described.
2. **Objective:** What the objective is of the individual project.
3. **Description:** A description of the proposed or existing pilot or project.
4. **Benefit:** How the investment will reduce costs, improve customer service, improve reliability, facilitate demand-side and renewable resources, or provide other system benefits.

### A. Transmission Network and Operations Enhancements

There are no transmission network or operations enhancement projects to report.

### B. Substation and Distribution Network and Operations Enhancements

#### *700-MHz Field Area Network*

##### **Present**

Idaho Power's current communications to field devices are limited to commercial cellular systems, which are difficult to secure, have high operation and maintenance (O&M) costs, and are subject to technology changes (e.g., constant evolution from 2G to 3G to 4G mobile telecommunications or cellular technology).



## Objective

A foundational element of the intelligent, flexible distribution grid is a secure, reliable, and affordable communication system. Idaho Power recently purchased 700-MHz radio spectrum to build a system-wide FAN. The FAN will be the foundational network to provide secure, reliable, and sustainable communications to distribution field devices.

The FAN will be Idaho Power's preferred station-to-field device communication network. It will enable advanced applications, such as IVVC, automated fault location, and voltage and current monitoring. The FAN provides visibility into the distribution system and field device control, creating a flexible system to meet, monitor, and adapt to changing conditions in the future.

## Description

A channel plan has been developed with the aid of an outside contractor, and installation will begin in 2018. Master radio stations will be installed at a couple of locations in the Boise area in 2018, and first use will be to provide communications to field devices associated with the IVVC system project described in the following section. Following the first installation, a phased approach will be taken to build out the 700-MHz FAN throughout Idaho Power's service area.

## Benefit

The benefits associated with deploying a FAN include the following:

- **Reliable**—Exclusive ownership and use.
- **Secure**—Protected from interference; strong Idaho Power-controlled cyber security.
- **Flexible**—Deployable in large or small areas; superior propagation characteristics.
- **Affordable**—Control/reduce O&M costs by reducing dependency on commercial cellular.

## ***Integrated Volt-VAr Control (IVVC) System Phase 1 Project (formerly known as Automated Volt/VAr Management)***

### **Present**

Idaho Power currently operates an automated capacitor control (ACC) system that controls reactive power flow at substation transformers by controlling distribution circuit capacitor banks. In place since the late 1990s, the ACC system is installed at 78 Idaho Power distribution substations. It uses one-way radio communications to command capacitor banks on and off with the goal to be near unity power factor at the substation transformer with a slightly leading power factor at heavy load and a slightly lagging power factor at light load. Control is performed via computers at each substation; the system is not currently centrally controlled.

The aging ACC system components are beginning to fail, leading to a system that is progressively less reliable. Direct replacement of the components is difficult because many are obsolete and no longer supported by vendors. Additionally, the current software system will soon become unsupportable in Idaho Power's cyber secure information technology (IT) environment.

The ACC system is not designed to operate with two-way power flow, nor does it provide visibility or control of the distribution system to optimize the voltage profile and minimize distribution system losses.

### **Objective**

Installation of an IVVC system will begin in 2018, with the intention to replace the obsolete ACC system and provide integrated control of capacitors, voltage regulators, and station LTCs. In previous smart grid reports, this was referred to as Automated Volt/VAr Management System (VVMS).

### **Description**

The IVVC Phase 1 project is currently in design, and a vendor-supported IVVC software system should soon be under contract, with purchase expected by the end of 2017. It is expected this project will occur in 2018 at a substation near Boise. Control and communications to the field devices will be established through the new Idaho Power 700-MHz FAN discussed previously. New intelligent line devices will be installed with the capability to communicate over the FAN and act autonomously if communications are lost. Once all integrated devices have been tested and the system has been validated, full replacement of the ACC system at the remaining 77 substations will follow using a multi-year, phased approach.

### **Benefit**

Benefits expected from the IVVC are as follows:

- Prioritize control and operation of capacitors, line voltage regulators, and LTCs.
- Provide higher level of visibility into the distribution system with additional voltage and current monitoring points communicated to operators.
- Optimize switching operations on devices, reducing wear and tear on equipment.
- Provide direct feedback on the status of devices through two-way communications. Reduce the need for seasonal inspections of distribution line devices; focus inspections on alarmed devices.
- Provide prompt alarms when devices fail. Reduce power-quality problems, such as voltage imbalances that occur from capacitor blown fuses and stuck regulators.
- Flatten the circuit voltage profile to defer or eliminate the need for system upgrades due to low voltage (optimize existing system).
- Aid distributed resource integration by adjusting line device actions under reverse power flow conditions.

## ***Jordan Valley Energy Storage Project***

### **Present**

A transformer located in the Jordan Valley Substation (Jordan Valley, Oregon) is currently operating around nameplate capacity during summer peak load. The transformer serves the city of Jordan Valley, serving both residential and commercial customers. The highest observed peak load was in the summer of 2016 when phase B of the transformer was overloaded by over 12 percent for a short duration. A project was approved to replace the transformer with a 4-megavolt ampere (MVA) transformer bank with an in-service date of October 2018. Idaho Power currently maintains a spare transformer and has mobile transformers that can be used in case of transformer failure. The project also includes upgrading the voltage regulator.

### **Objective**

Prices of battery energy storage technology have declined in recent years. As the price for this technology decreases, it becomes more feasible to use it to solve problems in certain instances that previously would have been solved through infrastructure upgrades and replacement. The company's analysis shows the Jordan Valley transformer replacement may be able to be deferred by balancing the transformer load and installing a battery energy storage system. The battery would be charged during light load conditions and discharged during peak load periods, relieving any potential transformer overload.

### **Description**

This project involves rebalancing the load on the transformer, installing an estimated 200-kW/150-kilowatt-hour (kWh) energy storage system (ESS), and partially replacing the transformer bank. For this project, one of the three single-phase transformer units could be replaced with a new unit of the same size every five years or as necessary. After 15 years, all three transformer phases will have been replaced. After this, circuit loading could be reassessed, and the battery could be replaced to continue to relieve any overload if necessary. The cost of the battery replacement in year 15 has been included in this analysis to represent a worst-case scenario. Final battery capacity is still being refined and may be larger or smaller than described.

Most batteries are warranted for approximately 10 years. Lithium-ion batteries can typically be cycled 3,000 to 5,000 times during their life if the cycling is within the batteries' designed depth of discharge limits. At the end of 10 years in this application, the battery will most likely have significant capacity left, as it is only anticipated to be cycled less than 50 times per year. It is expected that with properly managed operation and temperature controls, the battery will have sufficient life and capacity to last at least 15 years.

The present value cost of this project is estimated to be less than the present value cost of the originally planned transformer replacement project, including the single-phase transformer replacements every five years and a battery replacement in 15 years.

## **Benefit**

This proposed ESS project is a cost-effective alternative to replacing the Jordan Valley transformer. The design, installation, and operation of this system will give Idaho Power valuable experience with ESS technology and implementation.

## ***Substation Fiber-Based Protection and Control Pilot***

As reported in the *2016 Smart Grid Report*, Idaho Power, Schweitzer Engineering Laboratories, and Nokia were working to develop the digital equipment needed to implement a highly reliable substation fiber-optic network. The intent of the pilot project was to install a system that would parallel an existing substation protection and control system to demonstrate the reliability and viability of using fiber optics in lieu of copper wires to connect pieces of substation yard equipment to the control building for protection and control. However, Idaho Power was unable to come to contractual terms with Nokia. As a result, the Substation Fiber-Based Protection and Control Pilot program is not active at this time.

## **C. Customer Information and Demand-Side Management Enhancements**

### ***Ice-Based Thermal Energy Storage***

#### **Present**

In its *2015 Integrated Resource Plan (IRP)*, Idaho Power proposed a pilot project to investigate using ice-based thermal energy storage (TES).

#### **Objective**

The objective of this pilot is to investigate the costs and benefits of using TES.

#### **Description**

Ice-based TES systems can shift peak-hour air conditioning (A/C) load to off-peak periods. The load shifting occurs because the ice-based TES systems create ice during overnight off-peak hours, then use the stored ice in place of energy-intensive compressor units to provide cooling for A/C systems during peak-demand hours. Because the company has no previous experience with this technology, the company determined it would select a company-owned site to experiment with the technology. Based on deployments elsewhere, the typical customer for an ice-based TES system is from the commercial sector, into which many Idaho Power facilities fall.

#### **Conclusion**

Idaho Power worked on finding a company-owned facility for the installation of an ice-based TES system to pilot. Idaho Power selected a mid-sized office and storage facility that would be acceptable to modify the A/C units on part of the facility and compare to other units on that same facility. Idaho Power received proposals, then worked with one of the companies for a detailed cost estimate. The company determined the detailed cost estimate was substantially more

expensive than other demand response or generation technologies. Idaho Power has determined not to move forward with the pilot based on costs exceeding the benefits.

## **IV. SMART GRID OPPORTUNITIES AND CONSTRAINTS**

This section describes other smart grid opportunities Idaho Power is considering for investment over the next five to 10 years and any constraints that affect the company's investment considerations.

### **A. Transmission, Substation, Operations, and Customer Information Enhancements**

#### ***Personalized Customer Interaction***

Today, Idaho Power's customers using a desktop computer, tablet, or mobile phone can register and log in to myAccount to use the Energy Use Advising Tool to receive information regarding their energy use. Customers also have access to an outage map that displays current outages that affect more than 20 customers. The map provides information on the location of the outage, the number of customers impacted, crew status, and the estimated time of restoration, if known.

Through one new feature of the outage map, customers viewing an outage on the map can subscribe to receive text updates about the outage. Text updates include changes to the estimated time of restoration and confirmations of power restoration.

Idaho Power is preparing for continued growth in the multiple communication channels customers are using, and will use, to conduct business. Customers expect Idaho Power to proactively send them the information that is most important to them via the channel of their choice. These channels include the following: email, text messaging, phone applications, and social media platforms. Upon receiving this information, the customer will be empowered to adjust energy-using devices in their home or business to manage their energy use or respond to outages. Examples of topics where Idaho Power believes customers want more interactive engagement include the following:

- Outage information
- Billing and account alerts
- Energy-consumption alerts

Idaho Power will continue to explore opportunities to leverage existing systems to more actively engage its customers using the technologies preferred by customers.

## **B. Evaluations and Assessments of Smart Grid Technologies**

### ***Solar Forecasting Tool Development***

Idaho Power has joined a proposal team to offer advisory support to StormGeo, the Idaho National Laboratory (INL), South Dakota State University, and University of Texas at El-Paso on a research and development project titled *Hybrid Approach to Improved Solar Irradiance: Leveraging Remote Sensing and Adaptive Bayesian Forecasting*. With this work, StormGeo and team are addressing important issues in improving solar irradiance forecasting, which is of great interest for the subsequent improvement of system operations for Idaho Power and many electric utilities that have significant levels of solar power generation on their systems.

Improving solar irradiance forecasting is of key importance to provide accurate PV power forecasting that can benefit electric utilities in multiple ways. This proposal, if funded, will provide solutions to challenging grid issues (e.g., power balancing, reserve allocation) that power systems are facing due to increased penetration of variable renewable generation. Further, the solutions from this project will have broader applicability for improved system knowledge, forecasts, planning, and operations.

Idaho Power hopes to engage in the project and looks forward to the results and potential for use. Idaho Power is interested in improving its solar irradiance forecasts by leveraging the work done in this StormGeo-led project. The improvements in solar irradiance forecasts can help Idaho Power better allocate reserve resources for ensuring balancing and can also help distribution system operators improve operations and system planning.

The proposal has recently completed the answer cycle, which provides answers to reviewer comments and questions, and is currently in the final award decision process.

### ***Phased Implementation of Distribution Circuit Fault Locating***

Idaho Power strives to balance reliability and costs for customers. This balance is quantified and measured by maintaining reliability performance at the average of northwest peer-utility reliability performance.

Successful reliability programs focus on reinforcing under-performing distribution circuits and targeting upgrades to reduce outages for relatively large groups of customers. The current analysis shows the number of future projects with relatively low costs and high reliability impact are limited.

Future reliability performance goals will be achieved by continuing cost-effective distribution circuit reinforcing and phased implementation of targeted distribution automation. Distribution automation capabilities could be designed to directly reduce the duration of outages while supporting Idaho Power's core value of safety.

Included in the phased implementation of distribution circuit fault locating are the following:

- Add additional reclosers with communications via the 700-MHz radio system.

- Install communicating line sensor/fault indicators for fault locating and provide real-time data to SCADA.
- Add communications (700 MHz) to reclosers with a tie to SCADA for data acquisition and remote control.

The following benefits are expected from implementing fault-locating technologies:

- Improved customer satisfaction by reducing the duration of outages (SAIDI) through automation without compromising safety.
- Operational benefits, including real-time fault locating, remote indication, and control to isolate faults, which result in shorter response times.
- Greater situational awareness of the distribution system to operators and engineers.
- Fault location could enable real-time outage information to customers.

## **C. Smart Grid Pilots and Programs**

Although not organized or managed as a specific project, Idaho Power actively monitors smart grid-related technology advancements, articles, research, reports, demonstration projects, and demonstration results as applicable. As energy generation, consumption, and management technologies continue to improve, additional opportunities for the deployment of smart grid-enabled devices/appliances will become available. As these technologies continue to improve, it may be possible to create new products and services to help Idaho Power manage and optimize its system and help its customers manage their energy use, consumption, and distributed generation preferences. The areas currently being monitored include the management and integration of EVs, distributed resources, and microgrids.

## **D. State of Key Technologies**

Idaho Power's customers are increasing their use of electrical technologies while at the same time some customers desire to generate their own power. They also want to know more about the energy they use and be able to more finely control their usage. The enabling technologies that allow Idaho Power's customers to do this are available today and limited only by cost and maturity. As costs decrease, the company expects the technologies will be used and may change interactions and relationships from what they are today.

Key technologies Idaho Power is tracking include the following:

- Cost and technical maturity of PV generating resources
- Cost, technical maturity, and availability of EVs
- Smart inverters used for PV integration

- Technical maturity of tablet computing devices and available applications for energy tracking
- Energy storage technologies

## V. TARGETED EVALUATIONS

This section responds to the six smart grid-related recommendations adopted in OPUC Order No. 17-076, Docket UM 1675.

### Recommendation No. 1

*Continue to include Staff and stakeholder informal comments and corresponding Company responses in the 2017 Smart Grid Report.*

Idaho Power continues to include stakeholder informal comments and the company's respective responses as an appendix. This information is provided in Appendix A.

### Recommendation No. 2

*Host additional workshops with Staff and other stakeholders for their input in finalizing the program design of the TOD pilot.*

On February 14, 2017, Idaho Power held a webinar with OPUC staff to share the draft proposal for a time-of-day (TOD) pilot to be offered to Oregon residential customers. Idaho Power presented two cost-based options for TOD rate designs to the OPUC staff. The first option included an \$8 service charge with differentials between on-peak and off-peak periods based on differences in variable net power supply expenses during those TOD periods. The second option included a \$12 service charge, which resulted in larger differentials between the on-peak and off-peak rates as compared to the first option with the \$8 charge. The TOD energy rate differentials under the second option were also based on differences in variable net power supply expenses.

Idaho Power had a follow-up call with OPUC staff on August 30, 2017, to discuss opportunities for workshops in the near term with OPUC staff and other stakeholders. The company will continue to work with OPUC staff to determine the feasibility of a TOD pilot program, with an eye toward motivating behavioral change while implementing a rate design that reflects the cost to serve; the company plans to complete the evaluation of feasibility of such a pilot by January 1, 2018. If it is determined a TOD pilot is feasible, Idaho Power will conduct a workshop(s) with staff and other interested stakeholders to finalize the rate design.

### Recommendation No. 3

*Provide updated information on quantifiable benefits by populating the TBD fields in its Appendix H as applicable and continue to include any updates to the appendix in next year's report.*



Idaho Power continues to include the quantifiable benefits expected from all smart grid projects as an appendix. This information is provided in Appendix C.

## Recommendation No. 4

*Provide the final Observability study and explain the final implications of the study as it applies to PMU installations, the cost of the PMU installations, and how those PMU installations will benefit the Idaho Power system.*

An observability analysis identifies portions of the system observable using PMU measurements. A power system network is considered observable if the voltage vector at each node can be calculated based on PMU measurements. The observability analysis allows for the selection of the minimum set of PMU locations in the Idaho system necessary to implement an SE solution (system voltage magnitudes and angles) that serves as a foundational basis for performing measurement-based analysis. This SE solution based on PMU inputs is referred to as an LSE, which generates an almost real-time power flow solution of the observable system. Some of these applications can include the following:

- Contingency analysis
- Voltage stability analysis
- Automatic corrective actions
- Phase angle limit computation
- Analysis of cascading outages

The final Observability study prepared by V&R Energy Systems Research Inc. identified 78 PMU locations for an Idaho Power model that consisted of 361 buses to ensure complete observability of the Idaho bulk electric system (BES) (Appendix D). Because of a limited number of PMUs in place (~44), only partial observability of the Idaho Power BES system was achieved, and consequently its use in applications based on an SE solution is limited. For the additional 34 PMUs identified in the observability study, Idaho Power estimates it will cost approximately \$1.5 million based on the average cost of PMU installations in three existing locations.

## Recommendation No. 5

*In addition to providing updates on the LSE and the RT-VSMAC via an appendix similar to that in the 2016 report, provide a narrative explaining the elements of the appendix and explain how its updates related to the PRSP are benefiting the Idaho Power system.*

The three most recent quarterly Peak Reliability Synchrophasor Program (PRSP) Project Status reports are provided in Appendix E. The 2017 Quarter 1 report is the last status report requested by the DOE for this project. The DOE did not require a final report for this project, and the project is considered finished.

The Real Time-Voltage Stability Monitoring and Control Assistant project (RT-VSMAC) refers to the functionality of the ROSE tool and the implementation and validation of the LSE. The LSE has been addressed in the response to Recommendation No. 4.

ROSE, a real-time analysis tool, addresses the problem of using the PMU data to increase the situational awareness of the operator and improve stability and reliability of the electric grid. At this time, the current version of ROSE utilizes the Peak RC West Side Model, which is an SE solution based on SCADA measurements and made available to PRSP participants at regular intervals of approximately five minutes.

ROSE increases situational awareness of the operators by allowing them to accurately and timely predict steady-state instability in real-time environments and avoid blackouts by using phasor quantities collected by PMUs.

ROSE continuously monitors power system conditions by incorporating high-rate PMU data into the calculation of stability margins and visualizations and alarms the operator of the changes in the power system conditions (e.g., whether the system is “moving” closer to the boundary) before the next SE case arrives. This will allow the operator to take timely remedial actions to prevent system instability.

## Recommendation No. 6

*Track the progress of the CRM application and the CR&B upgrade and provide a robust narrative, complete with costs and benefits, describing how it intends to utilize CRM for personalized DSM purposes beyond what is already available to customers. The Company should also provide a robust narrative describing how its Savings Center will or won't help achieve new DSM offerings or energy management abilities, if any.*

Idaho Power completed the upgrade of its CR&B system in January 2017. This CR&B project was a technical upgrade to a current operating version to maintain vendor support. Completing the technical upgrade allows Idaho Power to move forward with integrating the CRM module within CR&B.

Idaho Power's objective for incorporating CRM functionality within CR&B is to allow Idaho Power to manage and track customer interactions related to energy efficiency and other customer relations activities with the goal of increasing the effectiveness of Idaho Power's program and service offerings. The benefit the CRM functionally provides Idaho Power is specific to improved communication and marketing tools and tactics. Benefits will include the following:

- Customer preference management—Expand communication channels like email and text.
- Customer segmentation—The ability to retrieve data from a variety of data sources for more effective and targeted marketing campaigns.
- Campaign management tools—Provide insight into the effectiveness of marketing campaigns.

Idaho Power is expecting the CRM functionality described above to be implemented in quarter 1 of 2018. Following the implementation of the CRM functionality, subsequent updates on this project will be included in the 2019 Smart Grid Report.

The myAccount customer portal within Idaho Power's website continues to be an effective tool for customers to manage their Idaho Power account. Most customers access myAccount to view and pay their monthly Idaho Power bill. myAccount provides access to detailed account and energy usage information, including a graphical display of current-month bill-to-date estimates compared to the same month of the prior year. This graphical display is a quick way for customers to gauge their current energy consumption compared to previous months.

The Savings Center, a subsection of myAccount, is a platform that provides customers information about their energy usage and how they can save energy. The Savings Center prompts the customer to provide information about their appliances and suggests common ways the customer can save energy and, ultimately, money. The Savings Center also provides the customer with an energy-use comparison tool to inform the customer of how their energy use compares to other similar homes. The Savings Center is a useful tool for customers to learn how they can save energy; however, it is not a driver to achieve new demand-side management (DSM) offerings or energy management abilities.

## VI. RELATED ACTIVITIES

### A. Cyber and Physical Security

All smart grid-related projects or plans conform to Idaho Power's Information Security standards, which are in place to secure its cyber assets. Idaho Power's aim is to strengthen its long-standing tradition of electric reliability while fostering a culture of compliance and satisfying a broad set of reliability standards.

Smart grid projects also conform to the requirements of Idaho Power's Physical Security program, preventing unauthorized access to personnel, equipment, material, and documents while safeguarding against espionage, sabotage, acts of terrorism, damage, and theft. Physical security is an integral part of all critical infrastructure protection and safety, fire, and crime prevention programs.

#### ***Timing Intrusion Management Ensuring Resiliency Project***

This DOE funded project involves Texas A&M University, Pacific Northwest National Laboratories (PNNL), and Idaho Power in the research, development, and demonstration of detection modules for timing intrusion management (both cyber and physical) in synchrophasor systems and other similar energy management systems to ensure resiliency of the systems.

Idaho Power will prepare its synchrophasor system to allow test access to a portion of the synchrophasor system as defined during the research phase of the project. Points of interest will include where the data processing and/or timing management is performed. Included in the research will be communication media and the protocols used to connect the equipment. While the Timing Intrusion Management Ensuring Resiliency Project team will undertake

coordinated parallel efforts on the research, development, implementation, and testing of the timing intrusion modules, Idaho Power will participate in specifying the application requirements, field evaluation requirements, and field evaluation of the developed timing intrusion modules.

The ultimate goal of this project is to evaluate the solution developed by the Texas A&M Engineering Experimental Station team in the field environment at Idaho Power under attack scenarios to be defined by the PNNL team.

Project negotiations and contract work started in 2016, with the first in-person meeting of the project partners occurring in February 2017 at Texas A&M University. This project is expected to reach the field testing stage in January 2018, with final reports to be completed in December 2019.

## **B. Privacy**

Idaho Power is committed to protecting the privacy of its customers and the data contained within company systems as stated in its *Corporate Security Policy* and evidenced by the company's Corporate Security program. For confidential data, such as customer information and energy usage data, Idaho Power limits access using a need-to-know approach enforced by role-based access controls for employees and contractors and supported by periodic required training. The policies and controls undergo periodic reviews to ensure they support applicable mandates and guidance.

Idaho Power recognizes new risks are emerging from smart grid technologies, both from the increase in data and the increasing interconnectivity of systems. To stay current on these, Idaho Power has joined collaborative public/private partnerships, such as the National Institute of Standards and Technology Smart Grid Interoperability Panel Cyber Security Working Group.

Idaho Power customers can access their energy usage data electronically via a registered and password-protected login (myAccount) on Idaho Power's website. Customers can also request that Idaho Power provide hard-copy usage information via fax, email, or mail.

Idaho Power provides protected customer information to entities other than the customer only under one of the following conditions:

- Receipt by Idaho Power of a court-ordered subpoena
- Presentation by a third-party of legal documentation substantiating the power of attorney for the customer of record
- Receipt by Idaho Power of written authorization from the customer of record identifying the third-party to whom information is to be released and specifying the information to be released
- Notification by a public utility commission that the customer of record has filed a complaint, at which point information will be provided to PUC staff

In addition to the above conditions under which information for an individual customer may be provided, Idaho Power has several contractual business relationships with third parties for the procurement of services essential to the operation of the business (e.g., bill print services) that are subject to non-disclosure agreements and data security requirements.

## C. General Customer Outreach and Education

Idaho Power recognizes the value of general energy efficiency awareness and education in creating behavioral change and customer demand for, and satisfaction with, its programs. The company achieves this by creating and delivering educational materials and programs that result in wise and informed choices regarding energy use and increase Idaho Power's energy efficiency program participation.

In 2016, Idaho Power continued to produce semiannual energy efficiency guides. Idaho Power distributed these guides primarily via insertion in local newspapers and at events across Idaho Power's service area. In 2016, the company distributed over 6,000 guides, including issues from past years, at energy efficiency presentations and events, which continued to reinforce the overall value of these guides. On its website, Idaho Power provides a link to the most current seasonal guide and to a list of historical guides.

Idaho Power distributed energy efficiency messages through a variety of other communication methods during 2016. Idaho Power increased customer awareness of energy-saving ideas via continued distribution of the third printing of the 96-page booklet *30 Simple Things You Can Do to Save Energy*, a joint publishing project between Idaho Power and The Earthworks Group. In 2016, the program distributed 2,595 English and 480 Spanish copies directly to customers.

In 2016, Idaho Power further enhanced its energy efficiency presence in the community by providing information through 92 outreach activities, including events, presentations, trainings, and other activities. In addition, Idaho Power customer representatives delivered 189 presentations to local organizations addressing energy efficiency programs and wise energy use. In 2016, Idaho Power's Community Education team provided 91 presentations on *The Power to Make a Difference* to 2,350 students and 53 presentations on *Saving a World Full of Energy* to 1,411 students. The community education representatives and other staff also completed 14 senior-citizen presentations on energy efficiency programs and shared information about saving energy to 592 senior citizens in the company's service area. Additionally, Idaho Power's energy efficiency program managers responded with detailed answers to 364 customer questions about energy efficiency and related topics received via Idaho Power's website.

At the outreach events, Idaho Power employees cover a wide range of information, answer customer questions, and assist customers in registering for the company's online self-help services. The company also promotes [idahopower.com](http://idahopower.com), using myAccount to help customers learn more about using energy, tips and ideas to save energy, energy efficiency program information, AMI meter information, payment options, and general company information.

As part of National Energy Awareness Month in October 2016, Idaho Power held its sixth annual student art contest in Idaho Power's service area, bringing energy education into the classroom and inspiring students and families to think more about energy. In 2016, the contest set a new record, with more than 2,239 entries representing all regions. Regional and overall winning students and their teachers were recognized.

## **Communications**

Idaho Power communicates frequently with customers through a variety of channels, including, but not limited to, billing statements, bill messages, bill inserts, *Connections* articles, customer letters, door hangers, postcards, brochures, web content at [idahopower.com](http://idahopower.com), hold messaging on the company's 1-800-488-6151 phone line, social media, public events, and customer visits.

Idaho Power has successfully leveraged the functionality of AMI and especially the hourly meter data to enable most of its customers to learn more about their energy use and how to use energy wisely. The company has used events and other channels to provide customers with relevant information on a frequent basis about energy efficiency, company and program information, and updates about AMI metering. Idaho Power also sends a new-customer welcome letter inviting them to visit [idahopower.com](http://idahopower.com) to learn more about their energy usage and to register on myAccount.

## **VII. CONCLUSION**

Idaho Power continues to refine its vision and strategy to anticipate what the future energy delivery system will look like and how it will meet customer needs and preferences, as well as improve company operations. The company is developing, testing, and deploying the technologies needed to facilitate the transition to a smart grid future and integrate renewable generation into the power system.

The company strives to enable more proactive customer interaction, as with the use of the updated myAccount landing page, the mobile website, and the outage map, which inform and enable participation by customers.

Idaho Power is dedicated to continuing efforts toward a smart grid system to provide its customers with an efficient, reliable, and safe power system that fits with customer expectations of a more interactive experience.

**Appendix A.  
Stakeholder input**

This page left blank intentionally.



HYDRO



# Share Your Ideas About **Smart Grid**

Idaho Power is preparing its annual smart grid investment report to the Public Utilities Commission of Oregon (OPUC). As part of this annual report, from August 8–25 we are seeking input, information and ideas from the public on smart-grid investments and applications.

Please go to [idahopower.com/smartgrid](http://idahopower.com/smartgrid) to review a draft version of the report. You'll also find more information about what the smart grid is, and how a smarter electrical grid can move the energy industry into a new era of reliability, availability and efficiency.

To share your input, please email [smartgrid@idahopower.com](mailto:smartgrid@idahopower.com) or call Idaho Power Regulatory Analyst Kristy Patteson at 208-388-2982.

A summary of customer comments will be provided to the OPUC with Idaho Power's report.

The smart grid represents energy innovation, leveraging a combination of improvements that enhance customer service, power reliability, availability of renewable resources, and opportunities for time, energy and cost savings. The 2013, 2014, 2015 and 2016 reports can be found on our website.

## Patteson, Kristy

---

**From:** Towell, Kimberly  
**Sent:** Tuesday, August 08, 2017 11:25 AM  
**To:** 'dockets@oregoncub.org'; 'oregondockets@pacificorp.com'; 'diane.broad@state.or.us'; 'john@grid-net.com'; 'renee.m.france@doj.state.or.us'; 'ffrisbee@si-two.com'; 'richard.george@pgn.com'; 'royhemmingway@aol.com'; 'bob@oregoncub.org'; 'pkeisling@gmail.com'; 'keith@caporegon.org'; 'adam@mrg-law.com'; 'douglas.marx@pacificorp.com'; 'wendy@mcd-law.com'; 'pge.opuc.filings@pgn.com'; 'john.volkman@energytrust.org'; 'michael.weirich@state.or.us'; 'dockets@renewablenw.org'; 'greg@richardsonadams.com'; 'stephanie.andrus@state.or.us'; 'erik.colville@state.or.us'; 'pge.opuc.filings@pgn.com'; 'wendy@nwenergy.org'; 'jdj@racinelaw.net'; 'judy.johnson@state.or.us'; 'sarah.kamman@pacificorp.com'; 'etta.lockey@pacificorp.com'; 'elo@racinelaw.net'; 'dreading@mindspring.com'; 'peter@richardsonadams.com'; 'irion@sanger-law.com'; 'dws@r-c-s-inc.com'; 'stephens@eslerstephens.com'; 'ortez@eslerstephens.com'; 'doug.tingey@pgn.com'; 'tony@yankel.net'; 'esteb44@centurylink.net'; 'cmfink@blueplanetlaw.com'; 'ott.irene@frontier.com'; 'charlie@gillis-law.com'; 'liz@oregoncub.org'; 'rkahn@nippc.org'; 'fkreider@campblackdog.org'; 'jkreider@campblackdog.org'; 'jravenesanmarcos@yahoo.com'; 'dockets@mrg-law.com'; 'irion@sanger-law.com'; 'gloria.smith@sierraclub.org'; 'alexa.zimbalist@sierraclub.org'; Michael Breish; 'mike@oregoncub.org'; Nadine Hanhan; 'jesse.d.ratcliffe@doj.state.or.us'; 'wendy.simons@oregon.gov'; 'shagunboughen@gmail.com'  
**Cc:** Nordstrom, Lisa; White, Tami; Tatum, Tim; Larkin, Matt; Youngblood, Mike; Patteson, Kristy; Barry, Christa; Aschenbrenner, Connie  
**Subject:** Idaho Power Company's 2017 Oregon Smart Grid Report - Comments Solicited  
**Attachments:** 2017 DRAFT Smart Grid Report.pdf; IPC Smart Grid Report Ad - Argus Observer and Hells Canyon Journal.pdf

Parties to Docket Nos. UM 1460, UE 233, LC 68, and UM 1675:

Idaho Power Company will be submitting its fifth annual Smart Grid Report to the Public Utility Commission of Oregon on October 1, 2017. As part of the annual report, Idaho Power is seeking public input and contributions from **August 8 through August 25, 2017**, on the attached Draft Smart Grid Report. To share your comments and ideas please email [smartgrid@idahopower.com](mailto:smartgrid@idahopower.com) or call Kristy Patteson at (208) 388-2982.

Public input is being solicited through advertisements in the *Argus Observer* and *Hells Canyon Journal* newspapers. A copy of the advertisement is also attached.

For more information about smart grid, and Idaho Power smart grid reports and projects, go to [www.idahopower.com/smartgrid](http://www.idahopower.com/smartgrid).

Thank you,

--

**Kristy Patteson**

REGULATORY ANALYST

Idaho Power | Regulatory Affairs

208-388-2982

Email [kpatteson@idahopower.com](mailto:kpatteson@idahopower.com)

**IDAHO POWER COMPANY'S RESPONSE TO INFORMAL COMMENTS FROM  
OPUC STAFF ON IDAHO POWER'S DRAFT 2017 SMART GRID REPORT**

Idaho Power did not receive informal comments from any parties on the 2017 draft report; therefore, no informal comments are included in this appendix.

-3 B  
 J K  
 J K  
 - Z **Go**

bc de

I .5K -? **B**  
 FGB - h2 ( f ( h \* )g h \*  
 603 i ) ij ( \* i j )  
 f h j h ( ) ( f j )  
 i h ) \* f  
 52  
 0 - **BK**  
 h j k i h  
 ( h h ) i ii  
 98 j i  
 F  
 7-3 2 S 18  
 G: **EF**  
 N J  
 V  
 3  
 93 :  
 FNE  
 F  
 D

7-3 2 S 18 9, **B**



7-3 2 S 18  
 h j k i h  
 ( h ) h i  
 ( j h l ; ) i ii  
 h h ) i ii  
 98 j i  
 F  
 7-3 2 S 18  
 G: **EF**  
 N J  
 V  
 3  
 93 :  
 FNE  
 F  
 D

93 :

-3 12  
 u  
 g  
 i  
 v  
 k  
 -3 12  
 go  
 h  
 ) \*\* k i  
 \*  
 i g  
 h

**Appendix B.**  
**Peak Reliability Project Plan**

This page left blank intentionally.



## **Project Plan**

### **Part A: General**

As more fully described below, PRSP Subrecipient will provide to Peak a licensed Linear State Estimator prototype and enhance Peak's currently licensed version of the Physical and Operational Margins ("POM") Region of Stability Existence ("ROSE"). PRSP Subrecipient will provide all of the requisite licenses to Peak for both the Linear State Estimator and POM ROSE.

POM, ROSE, and POM-State Estimator (POM-SE) are PRSP Subrecipient intellectual property.

Peak-ROSE software is a customization of ROSE software for Peak. Peak-ROSE software delivered during the project consists of the following programs:

- Physical and Operational Margins (POM);
- Optimal Mitigation Measures (OPM);
- Boundary of Operating Region (BOR);
- Potential Cascading Modes (PCM).

Two copies (one Real-Time and one Off-Line) of Peak-ROSE software will be delivered to Idaho Power Company ("IPC"), Southern California Edison ("SCE"), and San Diego Gas & Electric ("SDG&E"). One copy of real-time Peak-ROSE covers development, testing, training, and production environments.

POM-SE configuration for the project is POM- Linear State Estimator ("LSE") program. LSE prototype will be delivered to California Independent System Operator ("CAISO"), IPC, Peak, SCE, and SDG&E.

PRSP Subrecipient will build and make available the situational awareness wall. Based on cases created by LSE, measurement-based voltage stability analysis and corrective actions (previously known as remedial actions) are in scope.

### **Location of Project**

The Services will be delivered primarily in the Peak offices at 7600 NE 41st Street, Suite 150 in Vancouver, Washington or 4850 Hahns Peak Drive, Suite 120 in Loveland, CO ("Facility"). Some work may be accomplished remotely if deemed appropriate by Peak.

### **PRSP Subrecipient Furnished Property or Services**

PRSP Subrecipient is required to provide all computers, software, cell phones, and other supplies, materials or equipment reasonably needed to perform the required services.

### **Peak Furnished Property or Services**

Peak will provide PRSP Subrecipient with limited access to desk space, meeting or conference room space at Peak's premises for PRSP Subrecipient to perform the services under this Contract at no charge to PRSP Subrecipient.

### **Part B: Technical Requirements and Work Activities**

The Scope of Work for the software and support to be provided by the PRSP Subrecipient to support the PRSP is shown below.

#### **PRSP Subrecipient shall provide to Peak an LSE that meets all of the following functional requirements:**

The LSE shall perform the following functions as it relates to input data:

1. LSE shall be able to read a C37.118 data stream from any data source.
2. LSE shall be able to read a capture file as recorded and produced by Grid Protection Alliance's OpenPDC program.
3. LSE shall be able to read a CSV file format of future definition as determined by Peak Reliability and PRSP Subrecipients.

LSE shall be able to identify bad data, and to deliver a more correct value given the other measured quantities within close proximity to the bad quantity. LSE shall meet the following functional requirements associated with bad data detection and correction:

1. LSE shall detect and report topology errors or measurement errors.
2. LSE shall flag and report bad data in a manner that supports situational awareness of the bad data point.
3. LSE shall be capable of estimating and replacing a synchrophasor measured quantity given the appropriate measurement redundancy in the area.



4. LSE shall report to the user through a user interface and through automated reporting on a user configured periodicity (for example, once a day or once a week) synchrophasor data flagged as bad by LSE and/or replaced by LSE.
5. LSE will be able to create a “corrected” C37.118 data stream that includes the data that has been identified as bad and corrected by the LSE.
6. Bad Data Detection shall be able to run at a minimum of 30 times per second which will include a report identifying:
  - a. Any topology issues identified.
  - b. All suspected bad data will be replaced, and must be identified as being bad.
  - c. Provide results that enable the user to identify potential problem PMUs to examine for trouble shooting.

LSE shall meet the following Linear State Estimation requirements:

1. LSE will only refer to Phasor Measurement Unit (“PMU”) measurement-observable portions (islands) of the bulk electric system where a State Estimation will be executed.
  - a. LSE shall solve for all measurement observable portions of the system, whose bounds will be determined by the observability (or as allowed by current visibility) resulting in individual “islands” that are able to be solved by LSE throughout the system.
  - b. Non-measurement-observable portions of the system shall be equivalized through a method that will be reported to Peak and PRSP Subrecipients.
2. For non-observable parts of the system, where an iterative algorithm is needed, LSE shall provide a solution as fast as possible but not to exceed the “nominal” Westwide System Model (“WSM”) traditional State Estimator (“SE”) solution time of 10 seconds.
3. LSE shall enable the user to start and stop cycling of the LSE configurable through a user interface.
4. LSE must detect observability and provide information on observable islands in both text (i.e. delimited or tabular) and visual formats including:

- a. Identifying changes in topology which may affect visible islands (increase or decrease).
- b. Information for each measurement observable island shall include:
  - i. Number of measurements.
  - ii. Number/names of buses in observable islands.
  - iii. Identification of critical measurements which will have major impacts on the observability boundary. (those which will make the system more or less observable by virtue of their own)
5. LSE shall enable the user to access input, output, and change settings to run LSE.
6. LSE shall enable the user to execute LSE on demand or by schedule mechanism.
7. LSE shall be able to export a solution for each identified observable island as well as for the combined observable/non-observable system to be used by current and future versions of ROSE.
8. LSE shall be able to run in a debug mode / study mode to get a re-run of a chosen measurement set as previously specified in the document for the LSE input data requirements.
9. LSE will display to the user, the following post run information and diagnostic capabilities:
  - a. Start time of LSE execution;
  - b. End time of LSE execution; and
  - c. Measurement set identifiable for a given run (i.e. voltages, angles, flows, etc.).
  - d. Comparison of input quantities with the estimated quantities.
  - e. Presenting user with the severity of the bad data which was detected.
  - f. Exporting the solution in a CSV file including the following items: measurement values, estimate values (voltage and phase angle) and

identification of the measurement / estimate with area/zone/company name, station name, and bus name.

- g. Number of observable network portions.
- h. Availability of solution

**PRSP Subrecipient shall provide Peak-ROSE that meets all of the following functional requirements:**

1. Peak-ROSE shall be able to read and implement a full topology model as provided in the WSM export including:
  - a. Allowing for changes in topology without having to go through Study Network Analysis (“STNET”) to export another case;
  - b. Enabling topology processing;
  - c. Visually navigating the one-line display of the substation;
  - d. Using this for Remedial Action Scheme (“RAS”) modeling if equipment status is used.
2. Peak-ROSE shall be able to calculate self-sensitivities at each solved operating point ( $dV/dQ$ ) with a positive sensitivity indicating a stable system, while a negative sensitivity would indicate an unstable system. (i.e. operating on the underside of the Power Voltage (“PV”) curve).
  - a. This would give another needed indication of the true voltage stability, and help deal with some of the numerical instabilities that exist.
    1. Peak has witnessed ROSE solving on a low voltage solution and then reporting that interface value as the limit.
  - b. Peak Subrecipient states that they can calculate the bus with the highest self-sensitivity at the point of collapse (nose). Please provide more detailed explanation of how Peak Subrecipient accomplishes this.
3. Peak-ROSE shall be able to enable multi-threading in order for each run of Peak-ROSE to be completed within the same time it takes Real Time Contingency Analysis (“RTCA”) to run (currently every 5 minutes).
4. Peak-ROSE will include the following Output File Enhancements:

- a. Energy Management System (“EMS”) alarm output file including:
  1. Worst Contingency;
  2. Violated Element;
  3. Name and kV level of the weakest bus (for voltage stability);
  4. Volts Amps Reactive (“VAR”) margin at the weakest bus (for voltage stability);
  5. Phase angle values of given buses corresponding to Basecase and Voltage Stability Limit for data mining and the ability to determine phase angle pairs at a later time.
5. Peak-ROSE shall perform PV-Curve analysis on the base-case (pre-contingency) and post-Contingency and stop the computation at an injection level (for both base-case and post-Contingency PV analysis) at which any one of the following occurs first:
  - a. Stability violation is encountered;
    1. If for a contingency, stop computations for that contingencies but continue on with the other remaining contingencies
  - b. Source has reached its maximum capacity; or
  - c. Maximum transfer level as defined by scenario input file has been reached.
6. Peak-ROSE shall be able to add to the generator exciter capabilities/information Line Drop Compensation (LDC) /Reactive Current Compensation (RCC) consisting of adding or subtracting a reactance at the terminal to determine what and where the Automatic Voltage Regulator (“AVR”) will regulate, and to enable the user to view Reactive Capability Curve.
7. Peak-ROSE shall allow users to rearrange/add/subtract/filter/search the columns in the “tables” section and include LABELS in all of the components for better visibility. The LABELS will follow the naming convention of long EMS ID (up to 32 char) proposed by Peak and Bonneville Power Administration (“BPA”) for GE/PSLF and PowerWorld tools consistent with the Peak document detailing long EMS ID.

Objective	Activities
<b>Agreement Execution</b>	PRSP (PRSP Subrecipient and Peak) executed agreement
<b>ROSE Software Integration at Idaho Power Company (IPC)</b>	<ol style="list-style-type: none"> <li>1. Deliver ROSE software</li> <li>2. Integrate ROSE software, including configuration for use with Peak's real-time provided WSM</li> <li>3. Successful end-to-end test that demonstrates full functionality.</li> <li>4. Address and fix critical software defects</li> </ol>
<b>LSE Prototype at IPC - Observability Study</b>	<ol style="list-style-type: none"> <li>1. Observability study of Power Systems. Delivery is a report identifying existing measurement observability boundaries and desired PMU locations to provide improved observability for the LSE.</li> </ol>
<b>ROSE Software Integration at SDG&amp;E</b>	<ol style="list-style-type: none"> <li>1. Deliver ROSE software</li> <li>2. Integrate ROSE software, including configuration for use with Peak's real-time provided WSM</li> <li>3. Successful end-to-end test that demonstrates full functionality.</li> <li>4. Address and fix critical software defects</li> </ol>
<b>Peak-ROSE Enhancement #1: Peak-ROSE needs to read and implement a full topology model</b>	<ol style="list-style-type: none"> <li>1. Peak-ROSE shall have the capability to read and implement a full topology model</li> <li>2. Peak Subrecipient to provide release notes and announce to all participants that enhancement is available on Peak Subrecipient provided SFTP site. (Exhibit E, Peak-ROSE #1)</li> </ol>
<b>LSE Prototype at IPC</b>	<ol style="list-style-type: none"> <li>1. LSE software will be installed and tested using IPC data, and critical variances addressed by</li> </ol>

	<p>the vendor.</p> <ol style="list-style-type: none"> <li>2. Peak Subrecipient will successfully demonstrate end-to-end testing of the LSE using streaming C37.118 data as an input.</li> <li>3. The LSE software installed will be tested and satisfactorily meet all functional requirements described in Exhibit E.</li> </ol>
<b>Peak-ROSE Enhancement #2: Calculate Self-sensitivities</b>	<ol style="list-style-type: none"> <li>1. Calculate self-sensitivities at each solved operating point</li> <li>2. Peak Subrecipient to provide release notes and announce to all participants that enhancement is available on Peak Subrecipient provided SFTP site. (Exhibit E, V&amp;R ROSE #2)</li> </ol>
<b>Peak-ROSE Enhancement #3: Enable multi-threading</b>	<ol style="list-style-type: none"> <li>1. Enable multi-threading for ROSE</li> <li>2. Peak Subrecipient to provide release notes and announce to all participants that enhancement is available on Peak Subrecipient provided SFTP site. (Exhibit E, Peak Subrecipient ROSE #3)</li> </ol>
<b>LSE at CAISO</b>	<ol style="list-style-type: none"> <li>1. LSE software will be installed and tested using CAISO data, and critical variances addressed by Peak Subrecipient.</li> <li>2. Peak Subrecipient will successfully demonstrate end-to-end testing of the LSE using streaming C37.118 data as an input.</li> <li>3. The LSE software installed will be tested and satisfactorily meet all functional requirements described in Exhibit E.</li> </ol>

<b>Peak-ROSE Enhancement #4: Output File Enhancements</b>	<ol style="list-style-type: none"> <li>1. Output file enhancements to improve alarming and overall situational awareness</li> <li>2. Peak Subrecipient to provide release notes and announce to all participants that enhancement is available on Peak Subrecipient provided SFTP site. (Exhibit E, Peak Subrecipient ROSE #4)</li> </ol>
<b>LSE at SDG&amp;E</b>	<ol style="list-style-type: none"> <li>1. Observability study of Power Systems. Delivery is a report identifying existing measurement observability boundaries and desired PMU locations to provide improved observability for the LSE.</li> <li>2. LSE software will be installed and tested using SDG&amp;E data, and critical variances addressed by Peak Subrecipient.</li> <li>3. Peak Subrecipient will successfully demonstrate end-to-end testing of the LSE using streaming C37.118 data as an input.</li> <li>4. The LSE software installed will be tested and satisfactorily meet all functional requirements described in Exhibit E.</li> </ol>
<b>Peak-ROSE Enhancement #5: Enhancements to PV-Curve Analysis</b>	<ol style="list-style-type: none"> <li>1. Stop PV analysis if either of the following occur: <ol style="list-style-type: none"> <li>a. Stability violation is encountered.</li> <li>b. Source has reached maximum capacity.</li> <li>c. Maximum transfer level as defined in scenario has been reached.</li> </ol> </li> <li>2. Peak Subrecipient to provide release notes and announce to all participants that enhancement is available on Peak Subrecipient provided SFTP site. (Exhibit E, Peak Subrecipient ROSE #5)</li> </ol>

<p><b>LSE at SCE</b></p>	<ol style="list-style-type: none"> <li>1. Observability study of Power Systems. Delivery is a report identifying existing measurement observability boundaries and desired PMU locations to provide improved observability for the LSE.</li> <li>2. LSE software will be installed and tested using SCE data and critical variances addressed by Peak Subrecipient.</li> <li>3. Peak Subrecipient will successfully demonstrate end-to-end testing of the LSE using streaming C37.118 data as an input.</li> <li>4. The LSE software installed will meet all functional requirements described in Exhibit E.</li> </ol>
<p><b>LSE at Peak</b></p>	<ol style="list-style-type: none"> <li>1. LSE software will be installed and tested using Peak data and critical variances addressed by Peak Subrecipient.</li> <li>2. Peak Subrecipient will successfully demonstrate end-to-end testing of the LSE using streaming C37.118 data as an input.</li> <li>3. The LSE software installed will be tested and satisfactorily meet all functional requirements described in Exhibit E.</li> </ol>
<p><b>Peak-ROSE Enhancement #6: Add to the generator exciter capabilities/information</b></p>	<ol style="list-style-type: none"> <li>1. Add line drop compensation and reactive current</li> <li>2. Peak Subrecipient to provide release notes and announce to all participants that enhancement is available on Peak Subrecipient provided SFTP site. (Exhibit E, Peak Subrecipient ROSE #6)</li> </ol>
<p><b>Peak-ROSE Enhancement #7: Allow users to rearrange/add/subtract/filter/search the columns in the</b></p>	<ol style="list-style-type: none"> <li>1. Verify that users are allowed to rearrange/add/subtract/filter/search the columns in Tables</li> <li>2. Peak Subrecipient to provide</li> </ol>



<b>Tables</b>	release notes and announce to all participants that enhancement is available on Peak Subrecipient provided SFTP site. (Exhibit E, Peak Subrecipient ROSE #7)
<b>Peak-ROSE Enhancement Completion</b>	<p>Upon successful completion of all stated ROSE enhancements stipulated by Peak within Exhibit E, (#1 - #7) the following will be performed for each enhancement and overall POM performance (not to exceed 6 weeks upon completion):</p> <ol style="list-style-type: none"> <li>1. Successful end-to-end test that demonstrates full functionality</li> <li>2. Address and fix critical software defects</li> </ol>
<b>ROSE Software Integration at SCE</b>	<ol style="list-style-type: none"> <li>1. Deliver ROSE software</li> <li>2. Integrate ROSE software, including configuration for use with Peak's real-time provided WSM</li> <li>3. Successful end-to-end test that demonstrates full functionality</li> <li>4. Address and fix critical software defects</li> </ol>
<b>Measurement-based voltage stability analysis</b>	<ol style="list-style-type: none"> <li>1. Demonstrate that ROSE successfully performs voltage stability using LSE provided measurement-based cases as input.</li> <li>2. Deliver measurement-based ROSE software to participants</li> <li>3. Perform end-to-end testing for each participant to demonstrate that the measurement-based voltage stability works as expected.</li> <li>4. Address and fix critical software defects as identified by CAISO, IPC, SDG&amp;E, SCE and Peak.</li> </ol>

<p><b>Measurement-based corrective actions functionality in ROSE</b></p>	<ol style="list-style-type: none"> <li>1. ROSE shall identify corrective actions to mitigate the following conditions:             <ol style="list-style-type: none"> <li>a. Low voltage</li> <li>b. Voltage collapse</li> <li>c. Line and transformer thermal overload</li> </ol> </li> <li>2. Deliver correction action software to all participants</li> <li>3. Address and fix critical software defects identified by CAISO, IPC, SDG&amp;E, SCE and Peak</li> </ol>
<p><b>Building situational awareness wall</b></p>	<ol style="list-style-type: none"> <li>1. Provide display mockup of visualization wall</li> <li>2. Review participant comments and update display mockup as necessary to meet participant needs</li> <li>3. Develop visualization wall for implementation at participant sites.</li> </ol>
<p><b>Transferring the technology to project participants and training at Peak and TOs.</b></p>	

**Appendix C.  
Smart Grid Metrics**

This page left blank intentionally.

# Smart Grid Metrics

---

## II. STATUS OF CURRENT SMART GRID INVESTMENTS

---

### A. Transmission Network and Operations Enhancements

#### Transmission Situational Awareness Grid Operator's Monitoring and Control Assistant

- Description:** This project relates to the Linear State Estimator (LSE) and Region of Stability Existence (ROSE) tools. The LSE is a quasi-real-time state estimator solution based on PMU data. This provides for a non-iterative power flow solution of the (reduced) system. The ROSE tool will be fed by either the Peak RC state estimator or the LSE and will calculate real time a margin to voltage stability or to a Path SOL violation.
- Status:** Ongoing
- Benefits:** Avoid drifting into voltage instability during unforeseen operating conditions
- Cost:** \$272,000 as of March 31, 2017.
- Metric:** Increased awareness of voltage stability to avoid the risk of operating in an unsafe operating mode. Also act as backup to state estimator operated by Peak Reliability.

#### Dynamic Line Capacity Pilot

- Description:** Transmission line ratings are static and are based on conservative and often worst-case environmental factors. A dynamic transmission line rating system is based on real time or near real time measured environmental conditions, such as ambient temperature, wind speed and wind direction. This allows the line rating to be more accurate as it is based on actual conditions. An increase of at least 20% of the static line rating is often possible.
- Status:** Ongoing
- Benefits:** Transmission System increased operational flexibility and increased operating limits by replacing conservative assumptions with known measurements
- Cost:** \$466,000 total cost of project as of year end 2016
- Metric:** Identify the times when we make use of the additional capacity. (Note project is still in the pilot construction phase. Testing indicates that we will see capacity gains, but none to claim yet.)

---

## II. STATUS OF CURRENT SMART GRID INVESTMENTS (*continued*)

---

### A. Transmission Network and Operations Enhancements (*continued*)

#### Power System Engineering Research Center (PSERC)

**Description:** This is a PSERC High Impact Project: Life-cycle management of critical systems through certification, commissioning, in-service maintenance, remote testing, and risk assessment. The life-cycle management of critical systems is particularly complex since it requires tools and methodologies that are not readily available, so some custom approaches are typically taken, which may be costly. Typical examples are the deployment of synchrophasor based Wide Area Protection, Monitoring and Control (WAMPAC) and Special Protection System (SPS) where no standard tools for certification, commissioning, in-service maintenance and risk assessment are available. This project will deliver such tools and make some of them readily available for the industry to use at the host universities.

**Status:** Ongoing

**Benefits:** Awareness and/or implementation of new projects, methods and technologies that can increase the operational and planning efficiencies.

**Cost:** \$50,000 total cost of project

**Metric:** # of projects, methods and technologies that become adopted by the company.

# of Projects Adopted
0

## II. STATUS OF CURRENT SMART GRID INVESTMENTS (*continued*)

### B. Substation and Distribution Network and Operations Enhancements (*continued*)

#### Solar End-of-Feeder Project

**Description:** Explore and install a pilot project to determine the possible benefits of using energy storage, “smart” inverter technology and/or PV solar panels at the end of the feeder to improve distribution voltage.

**Status:** Complete

**Benefits:** Multiple customer voltage improvement

**Cost:** \$133,000 as of year end 2016

**Metric:** Deviations outside of ANSI C84.1

	2017
Deviations outside of ANSI C84.1	33

#### Electric Vehicle Activities

**Description:** Offer incentives for the installation of home charging stations and workplace charging stations .

**Status:** Ongoing

**Benefits:** Collect information on the barriers and opportunities related to home charging and charging behavior

**Cost:** This project was funded by shareholder dollars. No project costs were charged to customers.

**Metric:** Number of stations installed.

Electric Vehicle Program	# of Customers*	# of Sites*	# of Stations*
Home Electric Vehicle Charging Incentive Pilot	0	0	0
EV workplace Charging Station Incentive Program	9	15	31

\*2016 results only, 2017 results are pending

---

## II. STATUS OF CURRENT SMART GRID INVESTMENTS (*continued*)

---

### B. Substation and Distribution Network and Operations Enhancements (*continued*)

#### Replace the Existing Outage Management System

**Description:** Replace the existing Outage Management System (OMS). The new OMS will integrate into existing control and operating software platforms, including: the Geographic Information System (GIS), Supervisory Control and Data Acquisition (SCADA), Advance Meter Information (AMI), Mobile Workforce Management (MWM), and Customer Relationship and Billing (CR&B) systems.

**Status:** Complete

**Benefits:** Vendor Support of the application to accomplish faster identification of outage, more accurate count of customers impacted by the outage, enhanced outage communication with customers

**Cost:** \$3,060,332

**Metric:** Faster identification of, and a more accurate scope of, customer outages. (Metric results are pending – as Idaho Power gains experience operating the new OMS system, metrics will be developed and will be reported in a future Smart Grid Report.)



## II. STATUS OF CURRENT SMART GRID INVESTMENTS *(continued)*

### B. Substation and Distribution Network and Operations Enhancements *(continued)*

#### Automated Connect/Disconnect Capability

**Description:** Approximately 19,477 meters with remote controlled disconnect and reconnect capability have been installed at customer locations that historically required multiple visits annually. Remote connect/disconnect was implemented in Idaho on September 15, 2015 and in Oregon on August 16, 2016. In Oregon, Idaho Power only uses the remote disconnect functionality for customer requested disconnects.

**Status:** Complete

**Benefits:** Reduced connect/reconnect labor and expenses, collection labor and expenses, reduced reconnect fee in Idaho, reduced reconnect response time, improved employee safety.

**Cost:** \$1.0 million total cost of project

**Metric:** Change in head count, # of remote meters installed, # of remote disconnects, # of remote reconnects, change in reconnect fee, and reconnect response time\*\*.

Jurisdiction	Year	Positions Reduced	# of Remote Meters Installed	# of Remote Disconnects	# of Remote Reconnects	Change in Reconnect Fee
Idaho	2015	5	13,728	3,178	3,201	-\$7
	2016	0	15,145	10,211	10,144	\$0
	2017*	0	18,543	6,406	6,234	\$0
Oregon	2015	0	772	0	0	\$0
	2016	0	811	41	129	\$0
	2017*	0	934	64	179	\$0

\*January 1 through June 30, 2017

\*\*Remote reconnects occur every hour, at the top of the hour.

---

## II. STATUS OF CURRENT SMART GRID INVESTMENTS (*continued*)

---

### B. Substation and Distribution Network and Operations Enhancements (*continued*)

#### Implement Additional AMI Outage Scoping and Restoration Confirmation Functionality

**Description:** Integrate the AMI system with the Smart Grid Monitoring System (formerly known as the Sentry System).

**Status:** Complete

**Benefits:** See "Replace the Existing Outage Management System"

**Cost:** This work was included within the scope, cost, and schedule of the OMS replacement project.

**Metric:** See "Replace the Existing Outage Management System"

---

## II. STATUS OF CURRENT SMART GRID INVESTMENTS (*continued*)

---

### C. Customer Information and Demand-Side Management Enhancements (*continued*)

#### my Account (Energy Use Advising Tool)

**Description:** myAccount gives customers on-line access to Bill and Payment History, Usage History, Daily And Hourly Energy Use, Energy Use vs Degree Days, Pay My Bill, Ways To Pay My Bill, Add An Account, Electric Service Requests, myAccount Profile, Understanding My Bill, FAQs, How My Usage Compares, How I Use Energy, and When I Use Energy.

**Status:** Ongoing

**Benefits:** Provides customers with direct access to their account information including energy consumption patterns. Enhances customers' ability to be engaged and educated on ways to use energy more effectively and efficiently. Facilitated by the AMI system.

**Cost:** \$207,000 total cost of project

**Metric:** # of Monthly log-ins, # of myAccount customers that logged in

Month	# of Log-ins	# of Customers that logged in	Avg Log-ins/Day
July 2016	123,482	63,145	3,983
August 2016	132,986	66,805	4,290
September 2016	127,711	65,577	4,257
October 2016	125,894	66,627	4,061
November 2016	123,095	64,820	4,103
December 2016	130,954	65,414	4,224
January 2017	211,666	93,371	6,828
February 2017	201,953	92,445	7,213
March 2017	213,080	95,871	6,874
April 2017	191,679	93,555	6,389
May 2017	194,293	93,422	6,268
June 2017	193,903	93,686	6,463

---

## II. STATUS OF CURRENT SMART GRID INVESTMENTS (*continued*)

---

### C. Customer Information and Demand-Side Management Enhancements (*continued*)

#### Customer Relationship Management (CRM)

**Description:** Using the CRM capabilities of the CR&B system, the CRM application will retrieve data from a variety of data sources (meter usage data, customer data, demographics, program data, etc.). The software will provide the ability to query and report both formally and on an ad hoc basis. Customer preference management (opt-out, marketing frequency, topic choice, etc.) will also be a component of the system.

**Status:** Ongoing

**Benefits:** Manage and track customer interactions related to energy efficiency and other customer relations activities.

**Cost:** CR&B upgrade completed January 2017: \$1,732,413; CRM Project: TBD

**Metric:** Increased effectiveness of Idaho Power's energy efficiency program and service offerings

---

## II. STATUS OF CURRENT SMART GRID INVESTMENTS (*continued*)

---

### C. Customer Information and Demand-Side Management Enhancements (*continued*)

#### Direct Load Control

**Description:** Idaho Power has offered optional direct load control, or DR, programs since 2004 and to all of its customer segments since 2009. The company has offered an air conditioning (A/C) cycling program, A/C Cool Credit; an irrigation direct load control program, Irrigation Peak Rewards; and a commercial/industrial DR program, FlexPeak Management. The A/C Cool Credit and Irrigation Peak Rewards programs use smart grid technology, more specifically the power line carrier (PLC) technology to activate load control devices installed on customer equipment. All three programs use the hourly load data made possible by AMI to help determine the load reduction.

**Status:** Ongoing

**Benefits:** Demand response programs serve as a peaking resource during times of peak load on the Idaho Power system. Minimize or delay the needs to build supply-side peaking resources. Facilitated by the AMI system.

**Cost:** \$9,471,367 total 2016 annual expenses for demand response

**Metric:** Results from all three DR programs (MW and # of participants per program) and event reporting

Demand Response Program	# of Participants	Demand Reduction (MW)
2016 A/C Cool Credit	28,315	34
2016 Flex Peak Program	137	42
2016 Irrigation Peak Rewards	2,286	303

---

## II. STATUS OF CURRENT SMART GRID INVESTMENTS (*continued*)

---

### D. Distributed Resource and Renewable Resource Enhancements

#### Renewable Integration Tool

**Description:** The Renewable Integration Tool (RIT) was developed to provide the Load Serving Operators a more accurate wind generation forecast to utilize when balancing supply and demand. A wind generation forecast is generated for both day ahead and real time balancing purposes and displays the trends for both actual generation and the forecast generation for determining forecast accuracy. The day ahead and real time operators utilize this forecast to determine what resources are available and needed to serve firm system demand for the next day(s) and hour(s). The RIT is being expanded to forecast the solar generation that is scheduled to come on-line over the next few years.

**Status:** Ongoing

**Benefits:** Improved optimization of dispatchable resources

**Cost:** \$470,000 wind forecast project, \$60,000 solar forecast project

**Metric:** # of curtailments of renewable generation, amount of energy curtailed, amount of generation acquired during the hour as a result of renewable generation deficit.

# of Curtailments	Amount of Energy Curtailed	Amount of Generation Acquired as a result of renewable generation deficit
0	0	0

---

## II. STATUS OF CURRENT SMART GRID INVESTMENTS *(continued)*

---

### E. General Business Enhancements

#### The Mobile Workforce Management System Upgrade

- Description:** Upgrade the existing version of PragmaCAD to the latest version to maintain vendor support and realize improvements in the functionality of the latest version.
- Status:** Complete
- Benefits:** Vendor Support of application to optimize scheduling of customer appointments by location, employee skill, levelizing work load
- Cost:** \$1,246,468
- Metric:** Improved usability and a reduced number of software customizations which are now standard functionality.

	Before Upgrade	After Upgrade
Number of Software Customizations	8	2

---

### III. FUTURE SMART GRID INVESTMENTS

---

#### B. Substation and Distribution Network and Operations Enhancements

##### 700 MHz Field Area Network

**Description:** Install a 700 MHz licensed spectrum field area network to provide secure, reliable, and sustainable communications to distribution field devices.

**Status:** Future

**Benefits:** Reliable, secure, flexible and affordable communications

##### Integrated Volt-Var Control (IVVC) System Phase 1 Project

**Description:** The Installation of an IVVC system is intended to replace the obsolete automated capacitor control (ACC) system and provide integrated control of capacitors, voltage regulators, and station load tap changers (LTC).

**Status:** Future – In design

**Benefits:** Reduced feeder losses, decreased LTC operations, flatter feeder voltage profile

##### Jordan Valley Energy Storage Project

**Description:** Install an energy storage system as a non-wire alternative to a transformer replacement in Jordan Valley, Oregon.

**Status:** Future – In design

**Benefits:** Potential replacement cost reduction, gain experience with new technologies.



---

## IV. Smart Grid Opportunities and Constraints

---

### A. Transmission, Substation, Operations, and Customer Information Enhancements

#### Personalized Customer Interaction

**Description:** Proactively provide information to customers that is most important to them using email, text messaging, phone applications, and social media platforms.

**Status:** Future

**Benefits:** Improved customer satisfaction and reduces customer calls.

### B. Evaluations and Assessments of Smart Grid Technologies

#### Solar Forecasting Tool Development

**Description:** Improve solar irradiance forecasting.

**Status:** Evaluating/Assessing

**Benefits:** Better allocate reserve resources, improve operations and system planning.

#### Phased Implementation of Distribution Circuit Fault Locating

**Description:** Reduce the duration of outages while supporting Idaho Power's core value of safety.

**Status:** Evaluating/Assessing

**Benefits:** Improved customer satisfaction, shorter response times, greater situational awareness

---

## COMPLETED PROJECTS

---

### II. A. Transmission Network and Operations Enhancements

#### Transmission Situational Awareness Peak Reliability Hosted Advanced Application

**Description:** This provides remote access to Peak Reliability Coordinator (RC) state estimator as well as a set of displays used by Peak RC to monitor the interconnection. Peak Reliability's Hosted Advanced Applications (HAA) provides enhanced situational awareness of pre- and post-contingency system conditions that help Transmission Operators (TOPs) to reliably monitor their systems. The Hosted Advanced Applications File Management tool provides a means for HAA users to manage their files in the HAA environment including file transfer (state estimator solutions) between a local machine and the HAA environment.

**Status:** Complete

**Benefits:** The ability for the operators to determine whether a planned outage and/or forced outage (e.g. line out of service) would result in a system operating limit exceedance.

**Cost:** \$75,000 Annually

**Metric:** # of potential System Operating Limit (SOL) exceedances avoided

# of Potential SOL Exceedances Avoided
4

**COMPLETED PROJECTS (continued)**

**II. B. Substation and Distribution Network and Operations Enhancements**

**Conservation Voltage Reduction Enhancements**

**Description:** Minimize voltages on transformers while maintaining customers’ voltage levels to meet the National Service Voltage Standard (ANSI C84.1). CVR would also be able to reduce demand on transformers during peak load periods in response to capacity requirements. The scope of the project includes the following: validate energy savings associated with CVR using measured instead of modeled values; quantify the costs and benefits associated with implementing CVR; determine methods for expanding the CVR program to additional feeders; pilot methods for making Idaho Power’s CVR program more dynamic; and determine methods for ongoing measurement and validation of CVR effectiveness.

**Status:** Complete

**Benefits:** Validation of customer and utility energy and demand savings from CVR

**Cost:** \$263,000 total cost of project

**Metric:** kWh and kW reduction between typical and CVR operated feeders.

	Boise		Pocatello		Twin Falls		Ketchum		McCall		Ontario		Irrigation
	Commercial	Residential	Commercial	Residential	Commercial	Residential	Commercial	Residential	Commercial	Residential	Commercial	Residential	Irrigation
Energy	-2.16%	-2.39%	-1.75%	-1.28%	-0.89%	-0.57%	-2.47%	-2.58%	-0.61%	-1.21%	-0.31%	-1.50%	-0.52%
Demand	-3.12%		-4.95%		0.40%*		-1.58%		-3.39%		-1.85%		-2.98%

\*Red numbers indicate data points where energy use increased under CVR. Examining this data may prove useful for making CVR more dynamic and informing Idaho Power which seasons, days of the week, times of the day and temperatures CVR works best in a particular weather zone.

**COMPLETED PROJECTS (continued)**

**II. B. Substation and Distribution Network and Operations Enhancements (continued)**

**ENGO use for improving performance of CVR**

**Description:** Evaluate ENGO unit ability to mitigate voltage problems in place of more expensive solutions such as reconductoring or installing small voltage regulators.

**Status:** Complete

**Benefits:** Improve ability to apply CVR to feeders that currently have voltages too low to qualify for CVR.

**Cost:** \$59,410 total cost of project

**Metric:** Customer voltage improvement

Customer voltage improvement	
Substation Phase Balance Improvement-Maximum Average Phase Difference Reduction	0.1939 V
Flatten Feeder Voltage - Maxium Decrease in Standard Deviation*	0.797 V
Voltage Increase End of feeder (max)	2.219 V
Low Voltage Mitigation when CVR ON - % Fewer Low Voltage Readings at monitored locations	80.83%
Technical Loss Reduction due to ENGO units while in CVR Mode	3.33%
Average CVR Factor for Energy**	1.5
Reduction of Energy Consumption due to CVR**	3.75%

\* Decrease in standard deviation represents the difference between substation voltage and end of feeder voltage.

\*\* Calculation of CVR factor performed using day on/day off testing and calculating the difference in energy used from metering at substation end of feeder. This CVR factor is a combined number for all customer types connected to this feeder and represents only 4 weeks testing. No separation between customer classes performed. This CVR factor cannot be directly compared to CVR factors calculated in CVR Enhancements project and is only indicative of the positive potential for CVR.

---

**COMPLETED PROJECTS (continued)**

---

**II. C. Customer Information and Demand-Side Management Enhancements****Advanced Metering Infrastructure**

**Description:** Idaho Power has deployed the Aclara Two-way Automated Communications System (TWACS) on 99% of the retail customers served, 99% in Idaho and 93% in Oregon. The TWACS technology is installed in the distribution substation and communicates with meters through the distribution power line.

**Status:** Complete

**Benefits:** Reduced cycle billing and customer movement meter reading, reduced bill estimates, reduced cancel re-bills, reduced trouble call mileage (pinging), enhanced failure and voltage monitoring. Daily and hourly energy use information for 99% of customers.

**Cost:** \$71,281,847 total cost of project

**Metric:** Operation and Maintenance Cost Reduction (Docket No. UE 233, DR No. 343)

<b>Operation and Maintenance Cost Reduction (Idaho &amp; Oregon)</b>	
O&M Costs Reductions Related to Metering Activity	\$3,353,192
O&M Costs Reductions Related to Connect/Disconnects	\$4,045,913
<b>Total O&amp;M Benefits</b>	<b>\$7,399,104</b>

---

**COMPLETED PROJECTS (continued)**

---

**II. C. Customer Information and Demand-Side Management Enhancements (continued)****Customer Outage Map**

**Description:** Idaho Power's Outage Map application provides customers with near-real-time information about outages that impact their home or business. Idaho Power launched the online Outage Map application on April 28, 2015. The Outage Map is located on the Idaho Power website in the Outage Center. Customers can view either the full version if using a desktop computer or they can use the mobile version if using a mobile device. The map is tied to the Outage Management System and will be automatically updated every five minutes.

**Status:** Ongoing

**Benefits:** Improved customer service during electricity outages. The Outage Map enables Idaho Power to improve customer communication and better meet customer expectations. The following information will be available for known outages, both planned and unplanned: time the outage started, number of customers affected, the status of the restoration crew (in-route or on site), and the estimated time of restoration (ETR).

**Cost:** No additional costs were incurred by Idaho Power for this activity. The work was performed as regular work duties.

**Metric:** # of visits to the Outage Map on the Idaho Power website

# of visits to Outage Map*	
<b>Total Map Visits</b>	<b>477,483</b>

\*July 1, 2016 through June 30, 2017.

---

**COMPLETED PROJECTS (continued)**

---

**II. E. General Business Enhancements****Idaho Power Enterprise Data Warehouse**

- Description:** The Enterprise Data Warehouse (EDW) is a database for storing customer and meter data.
- Status:** Complete
- Benefits:** The EDW supports the Company's analytical and reporting, customer data viewing and analytics (see myAccount), ensures that reporting activities do not adversely impact performance of the source systems.
- Cost:** \$1,591,000 total cost of project
- Metric:** # of types of data (meter data, customer data), # of fields within each type of data

Meter Data (# of fields)	Customer Data (# of fields)
217	2403

---

**COMPLETED PROJECTS (continued)**

---

**II. E. General Business Enhancements (continued)****Meter Data Management System Upgrade**

- Description:** Upgrade the existing version of Itron Enterprise Edition (IEE) to the latest version.
- Status:** Complete
- Benefits:** Provided additional functionality - support of complex rate and billing options, enabled net metering rate option (validate and scale hourly data for net metered customers with negative #s). Moved IEE from the no longer supported Windows XP operating system to Windows 7 thereby eliminating certain security concerns. The upgrade also allowed Idaho Power to eliminate some customizations that are now part of the base product supported by Itron.
- Cost:** \$351,738 total cost of project
- Metric:** # of net metered customers in both Idaho and Oregon

<b>Jurisdiction</b>	<b>Customer Group</b>	<b># of Customers*</b>
Idaho	Residential	1,092
Idaho	Commercial	117
Idaho	Industrial	3
Idaho	Irrigation	4
Oregon	Residential	15
Oregon	Commercial	8
Oregon	Industrial	0
Oregon	Irrigation	9

\* Customer count as of June 30, 2017



---

**COMPLETED PROJECTS (continued)**

---

**IV. B. Evaluations and Assessments of Smart Grid Technologies****Electric Vehicle Charging Impacts Study**

**Description:** Evaluate the impact of residential EV charging on Idaho Power's distribution system.

**Status:** Complete in 2016

**Benefits:** Gain an understanding the likely impact to utility facilities of electric vehicle charging

**Cost:** \$51,000 total cost of project

**Metric:** Increase in household demand at peak

<b>Average Demand Increase (per participant)</b>	
Peak Hours (13:00 – 21:00)	After Peak (22:00 – 24:00)
13.3%	21.9%

<b>Maximum Demand Increase (per participant)</b>	
Peak Hours (13:00 – 21:00)	After Peak (22:00 – 24:00)*
125%	800%

\* Small home, energy efficient, likely only vampire (standby) loads

---

**COMPLETED PROJECTS (continued)**

---

**IV. B. Evaluations and Assessments of Smart Grid Technologies****Photovoltaic and Feeder Peak Demand Alignment Pilot**

**Description:** Conduct a study of a residential/small commercial feeder to determine the number of weather stations, including solar intensity monitors that need to be installed along the feeder to gather and characterize the solar/weather patterns. Gather feeder load data and correlate the feeder load to the solar generation potential along the feeder. Includes purchase and installation of (probably) permanent solar intensity monitors, PV panels, and power metering and recording equipment.

**Status:** Complete in 2016

**Benefits:** Gain an understanding of the potential for solar PV generation to contribute to feeder peak load demand reduction.

**Cost:** \$25,000 total cost of project

**Metric:** The cross correlation and time offset of the feeder load data in MW and the solar irradiance in Watt/m<sup>2</sup>.

	<b>Solar Peak Leads Load Peak (# of hours)</b>
Southerly	3.96 to 4.13
Global	4.00 to 4.02
Westerly	1.76 to 1.94

**COMPLETED PROJECTS (continued)**

**IV. B. Evaluations and Assessments of Smart Grid Technologies**

**Solar-Powered Parking Lot Lighting**

**Description:** High-pressure sodium lighting was replaced with high-efficiency LEDs in an employee parking lot. Solar panels were mounted on each light pole so that energy can be fed back onto Idaho Power’s distribution system when the solar panels produce more energy than the LED lights consume.

**Status:** Complete

**Benefits:** Lighting for parking lot on a net-zero annual energy basis

**Cost:** This project was funded by shareholder dollars. No project costs were charged to customers.

**Metric:** Annual Net consumption/generation in kWh

Year 1		Net kWh	Running
Month	Year	Consumption	Total
September	2013	8	8
October	2013	(5)	3
November	2013	244	247
December	2013	383	630
January	2014	417	1047
February	2014	277	1324
March	2014	(0)	1323
April	2014	(157)	1167
May	2014	(359)	808
June	2014	(382)	426
July	2014	(359)	66
August	2014	(262)	(196)
Running Total		(196)	
Negative = net generation Positive = net load			

Year 2		Net kWh	Running
Month	Year	Consumption	Total
September	2014	(144)	(144)
October	2014	2	(142)
November	2014	217	75
December	2014	412	487
January	2015	307	794
February	2015	28	822
March	2015	(188)	634
April	2015	(344)	290
May	2015	(339)	(48)
June	2015	(438)	(487)
July	2015	(403)	(890)
August	2015	(329)	(1219)
Running Total		(1,219)	
Negative = net generation Positive = net load			

Year 3		Net kWh	Running
Month	Year	Consumption	Total
September	2015	(214)	(214)
October	2015	(9)	(222)
November	2015	189	(34)
December	2015	405	371
January	2016	291	662
February	2016	22	684
March	2016	(22)	662
April	2016	(304)	358
May	2016	(347)	11
June	2016	(391)	(381)
July	2016		
August	2016		
Running Total		(381)	
Negative = net generation Positive = net load			

This page left blank intentionally.

**Appendix D.  
Final Observability Report**

This page left blank intentionally.

# **Grid Operator Monitoring and Control Assistant (GOMCA)**

## **Peak Reliability Synchrophasor Program**

April 2017

Report Prepared by:

V&R Energy Systems Research, Inc.  
11824 Darlington Avenue, Suite 101  
Los Angeles, CA 90049





# CONTENTS

---

<b>1. GRID OPERATOR MONITOR AND CONTROL ASSISTANT (GOMCA) UNDER PEAK RELIABILITY SYNCHROPHASOR PROGRAM (PRSP)</b> .....	<b>9</b>
<b>2. OPTIMAL PMU PLACEMENT FOR POWER SYSTEM OBSERVABILITY</b> .....	<b>11</b>
2.1 APPROACHES TO ANALYSIS OF POWER SYSTEM OBSERVABILITY.....	11
2.1.1 Numerical Approaches to Power System Observability Analysis .....	11
2.1.2 Topological Approaches to Power System Observability Analysis .....	12
2.1.3 Use of Linear Programming for Optimal PMU Placement .....	14
2.2 PURPOSE OF THE OBSERVABILITY STUDY FOR IPC .....	14
2.3 INITIAL GRAPH OF THE IPC SYSTEM.....	15
2.3.1 HasPmu Property .....	15
2.3.2 Zero Injection Property .....	15
2.3.3 Initial Graph for IPC .....	16
2.4 EQUIVALENT GRAPH REDUCTION.....	16
2.5 OPTIMAL PMU PLACEMENT FOR FULL SYSTEM OBSERVABILITY .....	17
2.5.1 Optimal PMU Placement for Full System Observability Using Linear Programming.....	17
2.5.2 Optimal PMU Placement for Full System Observability Using Linear Programming while Considering Kirchhoff's Law .....	18
2.5.3 Iterative Solution of Linear Programming Problem.....	19
2.5.4 Decreasing the Number of Variables .....	20
2.6 USING POM SUITE/ROSE AND MATLAB FOR PERFORMING OBSERVABILITY ANALYSIS.....	21
2.6.1 Setting up Observability Study.....	22
2.6.2 Identifying the Optimal Number of Iterations .....	22
2.6.3 Checking the Results of Optimal PMU Placement .....	23
2.7 STEPS TO RUN OBSERVABILITY STUDY.....	24
2.8 OBSERVABILITY ANALYSIS: File " <i>NODEINFOINITIALGRAPH.CSV</i> " FOR IPC SYSTEM .....	27

2.9	OBSERVABILITY ANALYSIS: File “ <i>NODEINFOREDUCEDGRAPH.CSV</i> ” FOR IPC SYSTEM .....	29
2.10	OBSERVABILITY ANALYSIS: File “ <i>IPC_PMU_LOCATIONS_2016.CSV</i> ” .....	30
<b>3.</b>	<b>PROCESS OF BAD DATA DETECTION AND CONDITIONING.....</b>	<b>32</b>
3.1	DETECTION AND CONDITIONING OF BAD DATA .....	32
3.2	DATA PRE-SCREENING.....	34
3.3	USE OF KALMAN FILTER.....	35
<b>4.</b>	<b>LINEAR STATE ESTIMATION AND OBSERVABILITY ANALYSIS FOR CAISO, IPC, PEAK RELIABILITY, SCE, AND SDGE .....</b>	<b>40</b>
4.1	State Estimation .....	40
4.2	Linear State Estimation Based on DC Power System Model .....	42
4.3	Bad Data Detection and Conditioning using Linear State Estimation.....	47
4.3.1	Using Heuristic Methods.....	47
4.3.2	Topology Estimation Using PMU Measurements .....	49
4.4	Observability Analysis .....	50
4.4.1	Creating an Observable Island .....	51
4.4.2	PMU/State Estimator Mapping.....	54
4.4.3	Results for PRSP Participants .....	56
<b>5.</b>	<b>LESSONS LEARNED: PMU DATA VALIDATION, BY IDAHO POWER COMPANY .....</b>	<b>64</b>
<b>6.</b>	<b>REFERENCES .....</b>	<b>65</b>
<b>7.</b>	<b>CONCLUSION.....</b>	<b>68</b>

# LIST OF FIGURES

---

Figure 1-1 High-Level GOMCA Architecture .....	9
Figure 2-1 Power System Network.....	13
Figure 2-2 Initial graph for IPC .....	16
Figure 2-3 Equivalent graph of IPC Network .....	16
Figure 2-4 Checking Results of PMU Placement.....	24
Figure 3-1 Bad Data Detection and Conditioning Process.....	33
Figure 3-2 Removing Data Dropouts.....	35
Figure 3-3 Measured vs. Predicted Values.....	38
Figure 3-4 PMU Viewer Interface .....	39
Figure 4-1 State Estimation Process .....	41
Figure 4-2 LSE as a Foundation of the Measurement-Based Analyses.....	46
Figure 4-3 An Example of Using Heuristic Rules .....	48
Figure 4-4 A Sample Substation Configuration with PMUs Installed.....	49
Figure 4-5 Five PMUs at a Substation.....	49
Figure 4-6 Six PMU Locations in the System .....	51
Figure 4-7 Step 1: Computing Flows and Voltages at Buses Connected to the Buses with PMUs .....	52
Figure 4-8 Step 2: Expanding the Set of Observable Buses.....	52
Figure 4-9 Step 3: Identifying Non-Observable Parts of the Network.....	53
Figure 4-10 Step 4: Creating a 26-Bus Model Using 6 PMUs.....	53
Figure 4-11 GOMCA Interface for Automatic Checking of PMU/SE Mapping .....	55
Figure 4-12 WSMViewer Splash Screen .....	56
Figure 4-12 Entity 1: Percentage of Observable Buses by Nominal Voltage .....	58
Figure 4-13 Entity 2: Percentage of Observable Buses by Nominal Voltage .....	60
Figure 4-14 Entity 3: Percentage of Observable Buses by Nominal Voltage .....	61
Figure 4-15 Entity 4: Percentage of Observable Buses by Nominal Voltage .....	62
Figure 4-16 Entity 5: Percentage of Observable Buses by Nominal Voltage .....	63



# LIST OF TABLES

---

Table 2-1	Sets of Binary Variables .....	19
Table 2-2	Decreasing Number of Decision Variables .....	22
Table 4-1	Summary of Results of Observability Analysis .....	56
Table 4-2	Entity 1: Twenty Seven Observable Islands .....	57
Table 4-3	Entity 1: Distribution of Observable Buses by Nominal Voltage .....	58
Table 4-4	Entity 2: Ten Observable Islands.....	59
Table 4-5	Entity 2: Distribution of Observable Buses by Nominal Voltage .....	59
Table 4-6	Entity 3: Two Observable Islands .....	60
Table 4-7	Entity 3: Distribution of Observable Buses by Nominal Voltage .....	60
Table 4-8	Entity 4: Two Observable Islands .....	61
Table 4-9	Entity 4: Distribution of Observable Buses by Nominal Voltage .....	61
Table 4-10	Entity 5: Two Observable Islands .....	62
Table 4-11	Entity 5: Distribution of Observable Buses by Nominal Voltage .....	62



# 1. GRID OPERATOR MONITOR AND CONTROL ASSISTANT (GOMCA) UNDER PEAK RELIABILITY SYNCHROPHASOR PROGRAM (PRSP)

Peak Reliability Synchrophasor Program's (PRSP) goal is to collaborate with transmission owners, transmission operators, and V&R Energy, an application vendor to develop, deploy, and test voltage stability software and linear state estimation software. Following successful testing and validation, software tools are made available to participating utilities to deploy for continued use.

Aligned with a primary objective of PRSP to manage and improve data quality, availability and accuracy, V&R Energy's Grid Operator's Monitoring and Control Assistant (GOMCA) provides a demonstration of V&R Energy's Linear State Estimator (LSE) on realistic Western Interconnection networks including: observability analysis, bad synchrophasor data detection and conditioning, and validation of cases created by LSE and their applicability to voltage stability analysis. The goals toward these objectives include developing techniques to better assess and maintain the accuracy and availability of synchrophasor data for use by engineers and operations personnel; determining an industry-wide standard of detecting and measuring bad data in the synchrophasor system; mitigating the effect on system performance of bad data; and reducing the quantity of bad measurements. This includes identification of missing or inaccurate data through the use of V&R Energy's LSE.

High level GOMCA architecture is shown in Figure 1-1.

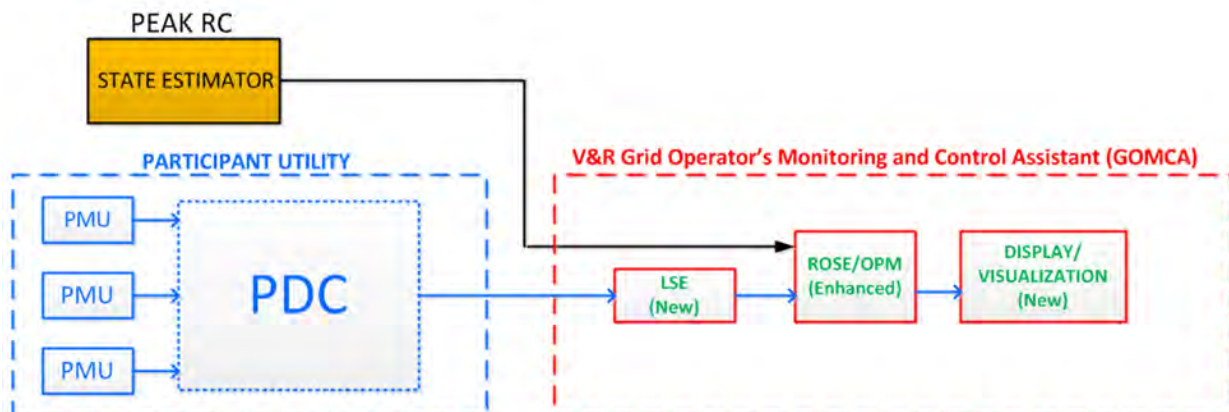

**Figure 1-1**  
**High-Level GOMCA Architecture**

Project participants are:

- Peak Reliability (Peak)—grant recipient and contract holder accountable to the Department of Energy, National Energy Technology Laboratory
- V&R Energy—research and software development; demonstration of technology, and project scheduler for Transmission Operators (TOPs) and Peak
- Cost-share project participants – CAISO, IPC, SCE and SDGE



# 2.

## OPTIMAL PMU PLACEMENT FOR POWER SYSTEM OBSERVABILITY

---

The phasor measurement unit (PMU) placement problem refers to the minimum number of PMUs to be placed in the network while maintaining observability of the entire electric power system network, [1], [2].

There exist multiple definitions of power system network observability. A power system is considered to be observable for a given network topology if voltage vector at each node can be calculated based on the PMU measurements. The definition of observability may be extended such that in addition to computing voltage vector, the values of load, generation and parameters of reactive sources (capacitors/reactors, VSC, FACTS devices, etc.) are calculated as well. In [3], a power system is defined as observable if “for a given topology and a set of available measurements, it is possible to determine the power flow across the system circuits”.

Since voltages are state variables for the steady-state model of a power system network, for the purpose of this study, we will consider a power system network to be observable if voltage vector at each node can be calculated based on the PMU measurements. This formulation includes several modifications, for example, considering PMUs that have been already installed, limiting the number of PMU measurements [4], incorporating PMU cost, excluding pre-defined locations [5].

### 2.1 APPROACHES TO ANALYSIS OF POWER SYSTEM OBSERVABILITY

Formulation of PMU placement problem depends on the definition of a criterion for complete system observability. There are two types of criteria to define system observability: numerical and topological, [6], [7]. Thus, there are two major approaches to power system observability: numerical methods and topological methods.

#### 2.1.1 Numerical Approaches to Power System Observability Analysis

Numerical definition assumes that there exists a system of linear equations

$$B(v) = m \tag{1}$$

such that equation

$$B^T B(v) = B^T m \quad (2)$$

has a unique solution,

where

$v$  is vector of bus voltages;

$m$  is the vector of measured voltages and currents.

The uniqueness of the solution is checked by transforming matrix  $B^T B$  to  $LDL^T$  form,

where

$L$  is a lower triangular matrix;

$D$  is a diagonal matrix.

When a power system network is fully observable, matrix  $D$  is a non-zero matrix, [9].

### 2.1.2 Topological Approaches to Power System Observability Analysis

Topological definition is based on identifying nodes where voltage either is measured by PMU or may be computed based on a PMU measurement at another node.

Consider a power system network with  $N$  nodes. Let  $X_i$  be a binary variable associated with bus  $i$ . Variable  $X_i$  is set to 1 if a PMU is installed at node  $i$ , else it is set to zero. Let  $Y_j$  be a binary variable associated with node  $j$  voltage. Variable  $Y_j$  is set to 1 if voltage vector at node  $j$  is known, else it is set to zero. Then, the objective function of optimal PMU placement to achieve full network observability in terms of topological definition can be formulated as follows:

$$\sum_i X_i \rightarrow \min, \quad (3)$$

$$\sum_i X_i + \sum_j Y_j = N.$$

There is no analytical expression to determine the value of variable  $Y_j$  (e.g., to check the statement that  $Y_j$  is set to 1 if voltage vector can be computed, and 0 – if it cannot be computed). Thus, whether voltage vectors can be computed based on the identified PMU placement can be only checked algorithmically. Thus, optimization approaches for optimal PMU placement are either based on search algorithms or some assumptions, and do not guarantee identification of minimum number of PMUs.

If voltage vector at a bus and current vector on a branch connected to the bus are measured by a PMU, then bus voltage at the other end of this branch may be computed. If there is only one circuit connected to a bus, or current on another circuit and all branches connected to this bus, except one branch, is known, current on this circuit may be computed using Kirchhoff's Law. If PMU measures voltage at one of a branch and another PMU measures current at the other end of this branch, then voltage at this bus (see Figure 2-1) is computed as follows:

$$V_j = \frac{V_i - ZI_j}{1 + ZY_j}, \quad Y_j = i\left(\frac{B}{2} + Y_{shunt}\right), \quad I_i = I_j + Y_jV_j + Y_iV_i, \quad (4)$$

where

$V$  = is complex vector of voltages,

$I$  = is complex vector of current,

$Y$  = is vector of admittance.

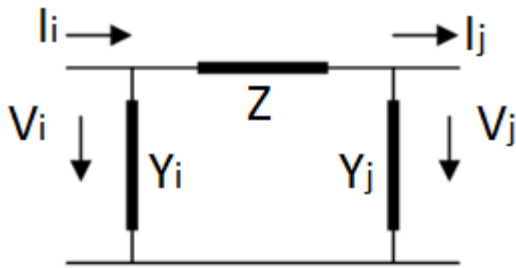

**Figure 2-1**  
**Power System Network**

Note that the above computation is also useful for bad data detection.

These computations allow to decrease the number of PMU installations.

In [4], a spanning tree approach is used to check the system observability. The advantage of this approach is that it allows to limit the number of measurements coming from one PMU, for example there may be one or two currents measured by one PMU. However, in this approach, the number of PMU locations depends on which bus is selected as a root (e.g., starting) bus of the tree. Thus, to ensure the minimum number of PMU placements, it is necessary to repeat the search using each network bus as a root bus. Another difficulty in using this approach is that the number of possible trees becomes overwhelming as the dimensions of the power system model increase, [8]. Therefore, a certain depth of observability is introduced to reduce the number of searches, [9].

Another approach to optimal PMU placements is the use of search algorithms, for example Improved Tabu Search (ITS), [10] – [12]. One more search algorithm, Non-dominated Sorting genetic algorithm, is introduced in [13]. Based on these references, currently search approached are effective only for small power system models.

### 2.1.3 Use of Linear Programming for Optimal PMU Placement

Formulating optimal PMU placement as a binary linear programming problem is the most frequently used approach, [2]. It is based on the following assumptions:

1. PMU installed at a bus directly measures bus voltage phasors and branch current phasors on all branches connect to this bus.
2. Buses where voltage phasor may be computed based on PMU measurements are connected to the bus where PMU is installed.

Use of assumption (2) above results in overestimation of the number of PMU locations. A realistic power system network has a large number of transition (e.g., zero injection) buses with no generators, loads, and switched shunts connected to this bus. Kirchhoff's law may be applied to compute voltage phasor at these buses, even if they are not directly connected with a bus where a PMU is installed.

The number of PMU installations may be significantly reduced by increasing the number of decision of variables and constraints in the linear programming formulation. An algorithm that considers zero injection buses in optimal PMU placement problem is described in [14].

Use of nonlinear programming for optimal PMU placement problem is presented in [15]. To solve the optimal PMU placement problem, the approach uses convex quadratic function and non-convex quadratic constraints. The advantage of this approach is that it has the ability to provide multiple solutions with the same number of PMU locations. The approach uses the upper bounds for the binary decision variables, which makes it easier to obtain the solution.

## 2.2 PURPOSE OF THE OBSERVABILITY STUDY FOR IPC

A system is considered to be observable if voltages at all system nodes are known. A number of PMUs have been already installed at Idaho Power Co. (IPC). The purpose of this study is to identify the optimal placement of additional PMUs such that IPC network becomes fully observable:

- PMUs should be placed such that voltage can be computed at all nodes at IPC.
- The optimal PMU placement is performed for a given system topology defined by the West-wide System Model (e.g., *WSMExport.csv* file):
  - The current study is performed for system topology described by file *WSMExport\_PowerWorldAux\_20151129.csv*.
  - The methodology is also tested for the system topology described by *WSMExport\_PowerWorldAux\_20160502.csv*.

- Locations of existing PMUs installed at IPC are incorporated during the optimal PMU placement analysis. These locations are defined in the file [WSM\\_PMU\\_OpenPDC\\_signal\\_mapping.csv](#).
- It is assumed that two nodes connected by switchgear have equal voltage. Therefore, these nodes can be collapsed. Only collapsed nodes are used during computations.
- It is assumed that if a PMU is located at a collapsed node (e.g., **PMU node**), current vectors on all branches connected to this node are also known.

## 2.3 INITIAL GRAPH OF THE IPC SYSTEM

Let us consider IPC footprint in the West-wide System Model, and collapse nodes at IPC footprint connected by switchgear. After consolidation is performed, the graph of IPC network consists of 361 collapsed nodes.

Detailed information about this graph is given in Attachment 1 [NodeInfoInitialGraph.xlsx](#). The graph is defined by 361 collapsed nodes and nodes adjacent to them. A node is considered an adjacent node if it is connected with any node that comprises a collapsed node through an in-service line or transformer.

### 2.3.1 HasPmu Property

A collapsed node is a PMU node if a PMU is installed at one of the original nodes comprising the collapsed node, as defined in file [WSM\\_PMU\\_OpenPDC\\_signal\\_mapping.csv](#). If a collapsed node is a PMU node, its **HasPmu** property is set to **True** in the [NodeInfoInitialGraph\\_20160516.xlsx](#).

### 2.3.2 Zero Injection Property

A collapsed node is considered a **Zero Injection** node, if the following conditions are satisfied:

- There are no generators, loads, and switched shunts connected to this node. Only in-service devices are considered.
- It is not connected with nodes outside of IPC's footprint via tie-lines.

Therefore, Kirchhoff's law may be applied to **Zero Injection** nodes.

### 2.3.3 Initial Graph for IPC

Initial graph for IPC is shown in Figure 2-2.

It has the following characteristics:

IPC Nodes = 361 Pmu Nodes = 21 Zero Injection Nodes = 158
---

**Figure 2-2**  
**Initial graph for IPC**

## 2.4 EQUIVALENT GRAPH REDUCTION

Let us further reduce IPC model. Nodes are removed from the graph if voltage at these nodes may be calculated using the rest of the model as follows:

1. A radial **Zero Injection** node is removed if it is connected with the rest of the graph only with one line. Thus, it has only one adjacent node. The process is repeated in a loop since after removing a node, an adjacent node may become a radial **Zero Injection** node.
2. A chain of **Zero Injection** nodes is replaced with one edge. Vertices of these edges become adjacent nodes. This substitution is done in a loop.

Note that PMU nodes should not be removed.

Equivalent graph of IPC network is shown in Figure 2-3.

It has the following characteristics:

IPC Nodes = 299 Pmu Nodes = 21 Zero Injection Nodes = 96
--

**Figure 2-3**  
**Equivalent graph of IPC Network**

Detailed information of this graph is given in Attachment 2 [NodeInfoReducedGraph.xlsx](#).

## 2.5 OPTIMAL PMU PLACEMENT FOR FULL SYSTEM OBSERVABILITY

### 2.5.1 Optimal PMU Placement for Full System Observability Using Linear Programming

The optimal PMU placement problem for complete system observability is solved by the binary linear programming approach.

Let us introduce the following notation:

$x_{Num}$  is a binary variable which shows the state of PMU installation, where

$$x_{Num} = \begin{cases} 1, & \text{if a PMU is installed at node } i \\ 0, & \text{if a PMU is not installed at node } i \end{cases}$$

Thus, if a PMU is installed at a node,  $x_{Num} = 1$ , otherwise it is equal to zero.

Current vectors on all branches connected to a **PMU node** are assumed to be known. Thus, voltage at this node can be computed if PMU is installed at either this node or an adjacent node.

An example for IPC graph:

Let us define the following variables:  $x_{32778}$ ,  $x_{32785}$ ,  $x_{32794}$ ,  $x_{32995}$ , etc. and consider node 32778 which has four adjacent nodes 32785, 32794, 32879, and 32995. Then, observability constraint for node 32778 is:

$$x_{32778} + x_{32785} + x_{32794} + x_{32879} + x_{32995} \geq 1$$

Objective function is minimization of the number of PMU installations, e.g., minimization of the sum of  $x_{Num}$ .

This is a standard integer linear programming problem, which can be solved by a standard solver. MATLAB solver was used for the simulation. As a result, **111 PMU locations were identified, including 21 existing locations.**

## 2.5.2 Optimal PMU Placement for Full System Observability Using Linear Programming while Considering Kirchhoff's Law

Algorithm described in Section 2.5.1 may be further enhanced. Let us consider a **Zero Injection** node and adjacent nodes. If voltage is known at all nodes but one, we can compute voltage at the latter node.

For example, node 32821 is a **Zero Injection** node with adjacent nodes 34003, 32827, 32828, and 33267 (see file *NodeInfoReducedGraph.txt*). According to Section 2.5.1, the following inequalities ensure observability of the corresponding node:

$$\text{Node 32821: } x_{32821} + x_{34003} + x_{32827} + x_{32828} + x_{33267} \geq 1$$

$$\text{Node 34003: } x_{32821} + x_{32881} + x_{32829} + x_{33810} + x_{34003} + x_{33369} \geq 1$$

$$\text{Node 32827: } x_{32827} + x_{32821} \geq 1$$

$$\text{Node 32828: } x_{32828} + x_{32821} \geq 1$$

$$\text{Node 33267: } x_{33267} + x_{32821} \geq 1$$

In order to define whether node voltage can be computed, let us introduce variables  $u_{32821}$ ,  $u_{34003}$ ,  $u_{32827}$ ,  $u_{32828}$ , and  $u_{33267}$  such that the following inequalities hold:

$$\text{Node 32821: } x_{32821} + x_{34003} + x_{32827} + x_{32828} + x_{33267} \geq u_{32821}$$

$$\text{Node 34003: } x_{32821} + x_{32881} + x_{32829} + x_{33810} + x_{34003} + x_{33369} \geq u_{34003}$$

$$\text{Node 32827: } x_{32827} + x_{32821} \geq u_{32827}$$

$$\text{Node 32828: } x_{32828} + x_{32821} \geq u_{32828}$$

$$\text{Node 33267: } x_{33267} + x_{32821} \geq u_{33267}$$

The observability constraint is changed as it is now not required that each **uNum** be equal to 1. Voltage being known at all nodes adjacent to **Zero Injection** node, except one, is a sufficient condition:

$$u_{32821} + u_{34003} + u_{32827} + u_{32828} + u_{33267} \geq 4$$

As a result, less number of PMUs are needed to be placed to ensure complete observability of the system.

MATLAB solver was used for the simulation. As a result, **88 PMU locations were identified, including 21 existing locations.**



### 2.5.3 Iterative Solution of Linear Programming Problem

Propagation of property “voltage is known” is an iterative process. Initially “voltage is known” at nodes where PMUs are installed. Based on voltage at these PMU nodes, voltage at adjacent nodes are computed at the next iteration. At the following iteration, we compute voltage at some other nodes using Kirchhoff’s Law for **Zero Injection** nodes, etc.

During this study, we introduced an approach that allows us to define this iterative process in terms of linear programming. Please note that the concept of “iteration” is not present in linear programming formulation. In order to build this iterative process, let us define sets of binary variables (e.g., having values of 0 or 1) as shown in Table 2-1.

**Table 2-1**  
**Sets of Binary Variables**

Property	Notation	Value
The state of PMU installation	$xNum$	1 - a PMU is installed, 0 - a PMU is not installed
Voltage is computed at node <b>Num</b> on the $i^{th}$ iteration	$uNum_i$	1 - voltage is computed, 0 - voltage is not computed
Voltage is computed at a group of nodes adjacent to <b>Zero Injection</b> node <b>Num</b> on the $i^{th}$ iteration	$gNum_i$	1 - voltage is computed at all nodes in a group, 0 - voltage is not computed at all nodes in a group

Property “voltage is known” propagates as follows:

$$x \rightarrow u_1 \rightarrow g_1 \rightarrow u_2 \rightarrow g_2 \rightarrow \dots \rightarrow u_i \rightarrow g_i \rightarrow \dots \rightarrow u_{MaxIter},$$

subject to the following conditions:

- $xNum = 1$ , if a PMU is installed at a node;
- $uNum_1 = 1$  if a PMU is installed ( $x = 1$ ) either at this or one of adjacent nodes;
- $gNum_1 = 1$ , for the group consisting of a **Zero Injection** node and adjacent nodes: if the total number of nodes where voltage was computed on the 1<sup>st</sup> iteration ( $n_1 = 1$ ) is greater or equal to the number of nodes in the group minus 1;
- ...
- $uNum_i = 1$  “voltage is known” at a node on the  $i^{th}$  iteration, if it was either known on the previous iteration  $i - 1$ , or the node is a part of the group in which we computed voltage on the previous iteration;

$gNum_i = 1$ , “voltage is known” at the group consisting of a **Zero Injection** node and adjacent nodes on the  $i^{th}$  iteration if the total number of nodes where “voltage is known” on this iteration ( $n_i = 1$ ) is greater or equal to the number of nodes in the group minus 1;

...

$uNum_{MaxIter} = 1$  “voltage is known” at all nodes on the last iteration.

The following inequalities ensure that the above conditions are satisfied:

$$xNum + \sum_{\substack{K=Node\ Numbers \\ connected\ to\ node\ Num}} xK \geq uNum_1$$

$$uNum_i + \sum_{\substack{K=Node\ Numbers \\ connected\ to\ node\ Num}} uK_i \geq (N_{Nodes} - 1) * gNum_i$$

$$uNum_{i-1} + \sum_{\substack{K=GroupNumbers \\ that\ contain\ node\ Num}} gK_{i-1} \geq uNum_i$$

MATLAB solver was used for the simulation. As a result, **80 PMU locations were identified, including 21 existing locations.**

#### 2.5.4 Decreasing the Number of Variables

The number of variables is of essential importance in mixed integer linear programming problem. When the number of variables is large, the solver either takes very long time to run (can be hours or days), or it fails to solve.

We introduced two approaches to decrease the number of variables.

After the number of variables is decreased, MATLAB solver identifies **78 PMU locations including 21 exiting locations.**

## **DECREASING THE NUMBER OF VARIABLES: APPROACH 1**

For nodes that are not adjacent to a **Zero Injection** node, we do not need to form variables at each iteration of the computational process.

Explanation: Property “voltage is known” propagates through the groups of nodes that are adjacent to a **Zero Injection** node.

## **DECREASING THE NUMBER OF VARIABLES: APPROACH 2**

For 21 **PMU nodes** and adjacent nodes, voltage is computed on the 1<sup>st</sup> iteration. Thus, creating variables for them is not needed.

## **2.6 USING POM SUITE/ROSE AND MATLAB FOR PERFORMING OBSERVABILITY ANALYSIS**

A significant number of algorithms have been developed to solve integer linear programming problem. There is no one single most effective algorithm. For certain computations some algorithms have been found more effective. Each of the algorithms also has a large number of settings. There are no rules for selecting optimal values of these settings, and these settings are frequently selected based on try-and-cut approach.

There also exist a large number of standard software products with built-in functions to solve integer linear programming problem. We tested the following software products to identify optimal PMU locations for IPC:

- Microsoft Solver Foundation;
- LPSolve;
- Extreme Optimization Numerical Libraries;
- MATLAB.

### 2.6.1 Setting up Observability Study

Observability study is executed as follows:

1. Execute program *LpModelForOptimalPmuPlacement.vb* from POM/ROSE interface in order to prepare linear programming model by identifying decision variables, writing the expression of the objective function and defining constraints:
  - Microsoft Solver Foundation was selected as the most effective tool for preparing linear programming model.
  - Model is written to an .mps file supported by Microsoft Solver Foundation.
2. Solve integer linear programming problem in MATLAB using the following steps:
  - Read the .mps file using function `mpsread`.
  - Run program `intlinprog` with default settings.
  - Results of observability study which list optimal PMU locations are written to a comma-delimited (.csv) file.
  - Note that it is useful to impose a limit on the run time. For example, run time to identify 78 PMU locations is 800 sec on a standard desktop.

### 2.6.2 Identifying the Optimal Number of Iterations

Parameter **MaxIter** (maximum number of iterations) was added to the linear programming model (see Section 2.5.22.5.3). The larger the value of **MaxIter**, the more accurate linear programming model is, and thus, the smaller the number of PMU locations. However, increasing the value of this parameter makes linear programming model more complex, and thus, the number of variables and constraints increases.

Table 2-2 shows how the number of the decision variables decreases using the approaches describer in Section 2.5.4.

**Table 2-2**  
**Decreasing Number of Decision Variables**

Value of MaxIter	Number of Decision Variables	Number of Constraints	Number of PMU Locations
0	298	319	111
1	629	650	82
2	960	981	78

\* - run time is 800 sec.

The study identified 78 PMU locations, including 21 locations of existing PMUs for IPC model that consist of 361 buses. It is usually assumed that buses with PMU installations comprise about 30% of the total number of buses in the model, [9]. The proposed solution allows us to decrease

the number of PMU installations approximately by 42 PMUs compared to convention techniques ( $361/3 - 78 = 42$  PMUs).

### 2.6.3 Checking the Results of Optimal PMU Placement

The results of optimal PMU placement may be checked using POM/ROSE script *Test101\_CheckPmuPlacement.vb*. The script checks that PMU locations as identified in Section 2.5.3 are sufficient to determine voltages at all nodes at IPC.

This check is performed as follows:

1. Graph of IPC system is defined by a list of node as well as the list of edges:
  - For each node: a list of edges coming from this node is created;
  - For each edge: a list of nodes connected by this edge.
  - Note that this approach allows us to compute node voltages, current on edges, as well as directly use Ohm's and Kirchhoff's Laws.
2. Initial graph reduction is not performed.
3. PMU mapping file is read and locations of existing PMUs are identified. It is assumed that voltages at these nodes and current on the edges coming from these nodes are known.
4. Propagation of property "voltage is known" as well as property "current is known" is performed. Propagation of these properties is an iterative process. At each iteration, propagation is computed using the following algorithm:
  - If voltage at a node and current on an edge coming from this node are known, then voltage at an opposite end node can be computed using Ohm's Law.
  - If voltage at two nodes connecting an edge is known, current on this edge can be computed using Ohm's Law.
  - If current on all edges connected to a **Zero Injection** node, except one, is known, current on this edge is computed using Kirchhoff's Law.
  - If voltages at all nodes adjacent to a **Zero Injection** node are known, voltage at a **Zero Injection** node can be computed.  
This is the most complex condition defined by a linear equation written for the unknown voltage:
    - Current on each edge is expressed in terms of this unknown voltage using Ohm's Law.
    - From Kirchhoff's Law it follows that the sum of these currents is equal to 0.

Results of the check performed for 78 PMU locations are shown in Figure 2-4.

```
Observable Nodes: 78, Edges: 233
Observable Nodes: 278, Edges: 321
Observable Nodes: 323, Edges: 383
Observable Nodes: 352, Edges: 400
Observable Nodes: 358, Edges: 407
Observable Nodes: 361, Edges: 407

Stage Check
IPC Nodes = 361
Zero Injection Nodes = 151
Pmu Nodes = 78
PMU Placement is good.
```

**Figure 2-4**  
**Checking Results of PMU Placement**

## 2.7 STEPS TO RUN OBSERVABILITY STUDY

To run the observability study in POM/ROSE and MATLAB, the following steps are performed:

1. Open POM/ROSE software.
  - 1.1 Load a project.
  - 1.2 Run script *LpModelForOptimalPmuPlacement.vb*:
    - a. Open the script
    - b. Set the control area number for IPC:  
`Const IpcArea = 19`
    - c. Enter the name of the mapping file for mapping PMU signals to nodes in the WSM file:  
`Const PmuFileName = WSM_PMU_OpenPDC_signal_mapping.csv"`
    - d. Enter the name of the LP model file:  
`Const LpModelFileName = "IpcLp.mps"`
    - e. Enter the maximum number of iterations  
`Const MaxIter = 2`

```

Const IpcArea = 19
Const PmuFileName = "WSM_PMU_OpenPDC_signal_mapping.csv"
Const LpModelFileName = "IpcLp.mps"
Const MaxIter = 2
Dim InitialPmuDecisionEliminating = False

ReadOnly Nodes As New List(Of Node)

Private Sub Go()
    CreateInitialGraph()
    EquivalentGraphReduction()
    If InitialPmuDecisionEliminating Then
        CreateLpModelWithInitialPmuDecisionEliminating()
    Else
        CreateLpModel()
    End If
End Sub

Sub CreateInitialGraph()
    CreateIpcGraph()
    PlacePmu()
    CheckNodeInjections()
    MarkObservabilityFromPmu()
    WriteGraphInfo("InitialGraph")
End Sub

Private Sub EquivalentGraphReduction()
    RemoveZeroInjectionNodesWithSingleNeighbor()
    RemoveChainsOfZeroInjectionNodes()
    MarkObservabilityFromPmu()
    WriteGraphInfo("ReducedGraph")
End Sub

Private Sub RemoveZeroInjectionNodesWithSingleNeighbor()
    Dim goon = True

```

```

Zero Injection Nodes = 96
Pmu Nodes = 21
Observable Nodes = 80
Graph Info in NodeInfoReducedGraph.txt

File IpcLp.mps created

Execution time: 2.58 s
Activity was successfully executed.
Iterations: 0

-----

Stage InitialGraph
IPC Nodes = 361
Zero Injection Nodes = 158
Pmu Nodes = 21
Observable Nodes = 113
Graph Info in NodeInfoInitialGraph.txt

Stage ReducedGraph
IPC Nodes = 299
Zero Injection Nodes = 96
Pmu Nodes = 21
Observable Nodes = 80
Graph Info in NodeInfoReducedGraph.txt

File IpcLp.mps created

Execution time: 2.29 s
Activity was successfully executed.
Iterations: 0

```

The script creates three output files:

- *IpcLp.mps*;
- *NodeInfoInitialGraph.txt*;
- *NodeInfoReducedGraph.txt*.

## 2. Open MATLAB.

2.1 Run function `mpsread` to read file *IpcLp.mps*:

```
p = mpsread('path\IpcLp.mps')
```

For example,

```
p = mpsread('C:\ROSE_IPC_Observability\VSA\Work\IpcLp.mps')
```

2.2 Run program `intlinprog` with default settings as follows:

```
options =
optimoptions(@intlinprog, 'PlotFcn', @optimplotmilp)
```

```
p.options = options
```

```
[x, fval, exitflag, output] = intlinprog(p)
```

Note, you can set to `options.MaxTime = 800` to decrease run time (e.g., to limit it to 800 sec).

2.3 Write the results of observability study (e.g., a list of optimal PMU locations) to a comma-delimited (.csv) file as follows:

```
p1 = readmps('ipclp.mps')  
writetable(table(transpose(p1.columnnames), x), 'PMUs.csv')
```

Results are saved to file *PMUs.csv*.

3. Go back to POM/ROSE software.

3.1 Run script *CheckPmuPlacement.vb*:

a. It reads contents of file *PMUs.csv*

```
Const MatLabResultFileName = "PMUs.csv"
```



## 2.8 OBSERVABILITY ANALYSIS: File “*NODEINFOINITIALGRAPH.CSV*” FOR IPC SYSTEM

Node Number	Station	Name	HasPmu	Zero Injection	Neighbors
32778	Axxx	300	FALSE	TRUE	(32785 32794 33879 32995)
32785	Axxx	800	FALSE	TRUE	(32778 33531 34258 33958 33340)
32794	Axxx	300	FALSE	TRUE	(32778 33879 32995)
32795	Axxx	800	FALSE	FALSE	(33572 32799)
32799	Axxx	800	FALSE	TRUE	(32795 34413 33541)
32802	Axxx	800	FALSE	FALSE	(32812 32815 33053 33736)
32812	Axxx	810	FALSE	TRUE	(32802)
32815	Axxx	813	FALSE	FALSE	(32802)
32821	Axxx	100	FALSE	TRUE	(34017 32827 32828 33267)
32827	Axxx	1300	FALSE	FALSE	(32821)
32828	Axxx	1301	FALSE	FALSE	(32821)
32829	Bxxx	138	FALSE	TRUE	(34003 32836 34300)
32836	Bxxx	1002	FALSE	TRUE	(32829 32837)
32837	Bxxx	1003	FALSE	TRUE	(32836 32839)
32839	Bxxx	1100	FALSE	FALSE	(32837)
32840	Bxxx	800	FALSE	FALSE	(34517 33226)
32849	Bxxx	803	FALSE	FALSE	(34408 33843)
32852	Bxxx	1200	FALSE	FALSE	(32856)
32856	Bxxx	800	FALSE	TRUE	(32852 34184)
32858	Bxxx	800	TRUE	TRUE	(34444 32868 32869)
32868	Bxxx	1001	FALSE	FALSE	(32858)
32869	Bxxx	1002	FALSE	FALSE	(32858)
32873	Bxxx	600	FALSE	FALSE	(33382)
32881	Bxxx	800	FALSE	FALSE	(33562 34000)
32884	Bxxx	800	FALSE	TRUE	(34485 33012 32891)
32891	Bxxx	1004	FALSE	FALSE	(32884)
32893	Bxxx	200	FALSE	TRUE	(34272 33249)
32903	Bxxx	804	FALSE	FALSE	(33450 34513) (32984 32986 32983 33907 32940 32948 32985 32941 32947 33899)
32908	Bxxx	200	TRUE	TRUE	33495 33769 33298)



## 2.9 OBSERVABILITY ANALYSIS: File “*NODEINFOREDUCEDGRAPH.CSV*” FOR IPC SYSTEM

Node Number	Station	Name	HasPmu	Zero Injection	Neighbors
32778	Axxx	300	FALSE	TRUE	(32785 32794 33879 32995)
32785	Axxx	800	FALSE	TRUE	(32778 33531 34258 33958 33334)
32794	Axxx	300	FALSE	TRUE	(32778 33879 32995)
32795	Axxx	800	FALSE	FALSE	(33292 32799)
32799	Axxx	800	FALSE	TRUE	(32795 34413 33541)
32802	Axxx	800	FALSE	FALSE	(32815 33053 33736)
32815	Axxx	813	FALSE	FALSE	(32802)
32821	Axxx	100	FALSE	TRUE	(34003 32827 32828 33267)
32827	Axxx	1300	FALSE	FALSE	(32821)
32828	Axxx	1301	FALSE	FALSE	(32821)
32829	Bxxx	138	FALSE	TRUE	(34003 32839 34300)
32839	Bxxx	1100	FALSE	FALSE	(32829)
32840	Bxxx	800	FALSE	FALSE	(34517 33226)
32849	Bxxx	803	FALSE	FALSE	(34408 33843)
32852	Bxxx	1200	FALSE	FALSE	(34184)
32858	Bxxx	800	TRUE	TRUE	(34444 32868 32869)
32868	Bxxx	1001	FALSE	FALSE	(32858)
32869	Bxxx	1002	FALSE	FALSE	(32858)
32873	Bxxx	600	FALSE	FALSE	(33382)
32881	Bxxx	800	FALSE	FALSE	(33562 34003)
32884	Bxxx	800	FALSE	TRUE	(34485 33012 32891)
32891	Bxxx	1004	FALSE	FALSE	(32884)
32903	Bxxx	804	FALSE	FALSE	(33450 34513)
32908	Bxxx	200	TRUE	TRUE	(32984 32986 32949 33122 33576 33888 33495 33769 33298)
32949	Bxxx	800	FALSE	FALSE	(33443 33850 33450 33355 33135 32908 32984 32986)
32978	Bxxx	1001	FALSE	FALSE	(32984)
32981	Bxxx	1101	FALSE	FALSE	(32986)
32984	Bxxx	2	FALSE	TRUE	(32908 32949 32978)
32986	Bxxx	4	FALSE	TRUE	(32908 32949 32981)
32995	Bxxx	3044	TRUE	TRUE	(33004 32794 33003 32778)

**2.10 OBSERVABILITY ANALYSIS:**  
**File “*IPC\_PMU\_LOCATIONS\_2016.CSV*”**

Location	Initial
Bxxx_345_3044	1
Mxxx_345_3062	1
Dxxx_138_820	0
Mxxx_138_807	0
Dxxx_138_822	0
Txxx_138_800	0
Axxx_138_800	0
Mxxx_138_800	0
Axxx_115_100	0
Vxxx_138_800	0
Bxxx_138_803	0
Pxxx_138_800	0
Txxx_138_805	1
Bxxx_138_800	1
Exxx_69_605	0
Hxxx_138_801	1
Uxxx_138_800	0
Uxxx_138_805	0
Lxxx_230_202	1
Mxxx_230_200	1
Bxxx_230_228	1
Bxxx_138_800	0
Bxxx_230_200	1
Bxxx_230_200	1
Bxxx_230_201	1
Wxxx_138_800	0
Bxxx_138_800	0
Hxxx_138_803	0
Kxxx_230_203	1
Rxxx_138_802	1
Bxxx_138_806	0
Oxxx_230_200	0
Hxxx_230_206	1
Bxxx_138_804	0
Cxxx_138_800	0
Mxxx_138_800	0
Cxxx_138_800	0
Lxxx_230_205	1

Cxxx_230_207	1
Nxxx_34.5_1100	0
Cxxx_34.5_1103	0
Mxxx_138_803	0
Exxx_138_804	0
Exxx_138_803	0
Exxx_138_800	0
Uxxx_138_811	0
Sxxx_138_800	0
Hxxx_138_800	0
Rxxx_12.5_1101	0
Wxxx_138_803	0
Hxxx_138_800	0
Rxxx_138_800	0
Sxxx_138_800	0
Hxxx_138_805	0
Nxxx_138_800	0
Hxxx_138_601	0
Jxxx_138_800	0
Ixx_138_800	0
Mxxx_230_205	1
Kxxx_138_800	0
Lxxx_138_800	0
Kxxx_345_305	1
Kxxx_14.4_1000	1
Nxxx_138_802	0
Mxxx_500_901	1
Rxxx_138_800	0
Nxxx_138_800	0
Nxxx_230_203	0
Pxxx_138_800	0
Wxxx_138_800	0
Pxxx_138_800	0
Sxxx_138_802	1
Sxxx_69_800	0
Sxxx_138_802	0
Txxx_138_804	0
Txxx_138_805	0
Wxxx_69_1000	0

# 3.

## PROCESS OF BAD DATA DETECTION AND CONDITIONING

---

### 3.1 DETECTION AND CONDITIONING OF BAD DATA

PMUs are expected to generate highly accurate measurements. For example, according to the IEEE standard [16, 17] the total vector error (TVE) between a measured phasor and its theoretical value should be well within 1% under steady state operating conditions.

However, this performance is not always achieved in the actual field installations due to unbiased random measurement noise and biased errors from the instrumentation channels [18, 19]. In addition to instrumentation errors and measurement noise, PMUs may exhibit errors due to synchronization, sampling and communication problems.

The process of bad data detection identifies the erroneous PMU measurements. The objective of bad data detection under PRSP is to address concerns regarding quality of synchrophasor data by establishing a computationally simple and efficient process for identifying and conditioning this data.

The overall bad data detection and conditioning framework demonstrated under the PRSP is shown in Figure 3-1.

Bad data detection consists of the following stages:

1. Several pre-screening techniques are used first.
2. They are followed by data range checks.
3. Combination of filtering and smoothing techniques using a quadratic prediction based Kalman filter is then performed.
4. After steps (1) – (3) are completed, a pre-conditioned PMU data stream is generated.
5. Pre-conditioned PMU stream along with the system topology (e.g., power system model defined in a real-time state estimator case) and PMU to State Estimator mapping file are used as inputs to perform observability analysis and run linear state estimation (LSE).
6. If in the process of LSE, bad data detected, it is conditioned and there are two major outputs of this analysis: a conditioned PMU data stream and an LSE base case.
7. Computation (6) also checks if an event has occurred in the system. When an event occurs, system topology is modified, which triggers observability analysis and updates results of LSE.

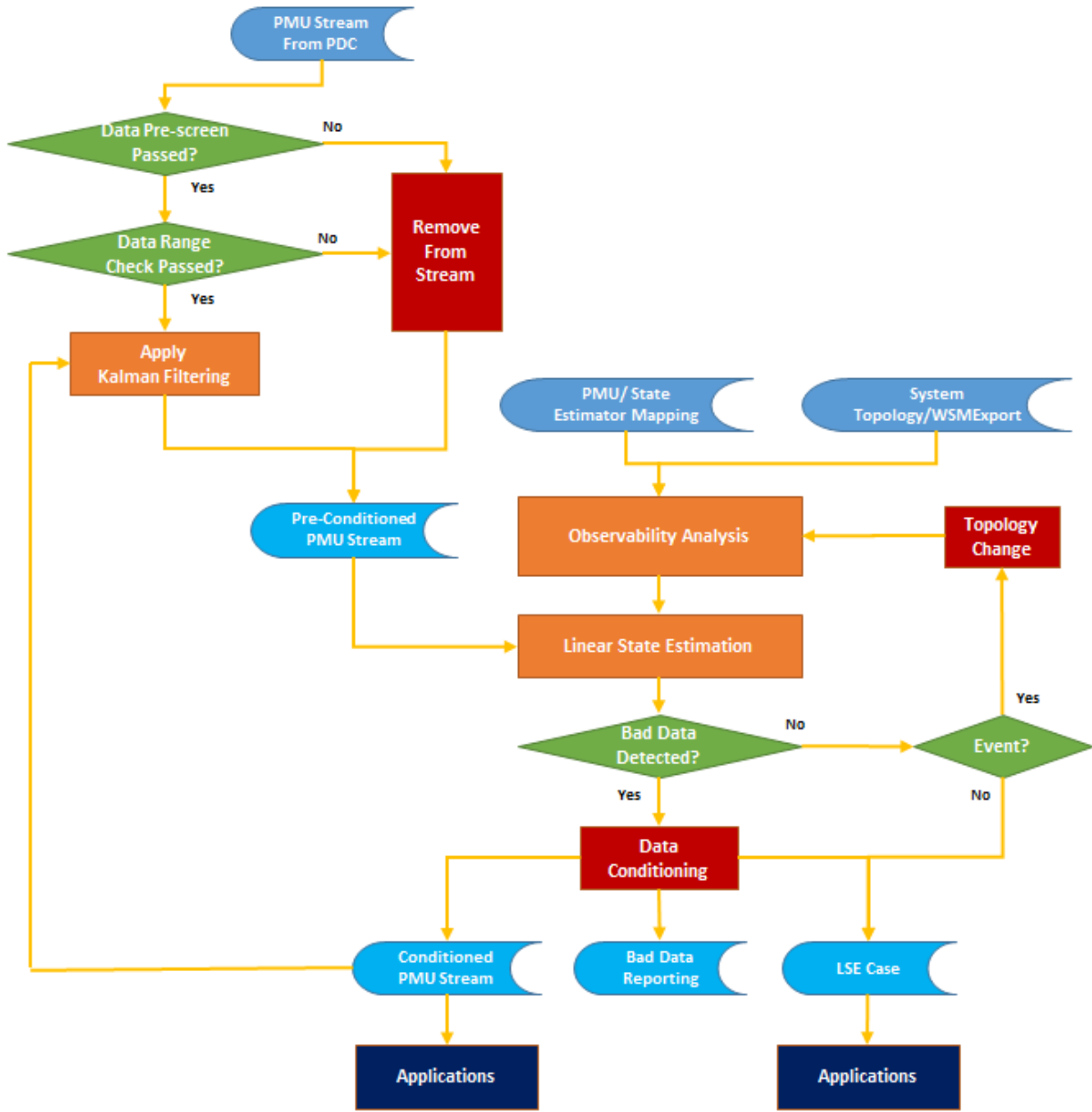

**Figure 3-1  
Bad Data Detection and Conditioning Process**

This Section describes the pre-screening techniques, data range checks and use of Kalman filters. Section 4 describes the process of linear state estimation and emphasizes the importance of correct mapping between PMU signals and power system model described by a state estimator (SE) case.

The analysis was performed using the synchrophasor data received from CAISO, IPC, Peak, SCE, and SDGE.

## 3.2 DATA PRE-SCREENING

Prior to using the Kalman filtering, simple pre-screening checks for validating the quality of the PMU data are performed.

Some of the pre-screening checks are:

- In-service buses having zero, near zero or negative values of voltage magnitude measurement
- In-service lines having zero or near zero values of current magnitude measurement
- Frames with the C37.118 *DataValid* bit asserted
- Frames with the C37.118 *PMUSync* bit asserted
- Frames with the C37.118 *PMUError* bit asserted
- Frames which have other problems communicated via the C37.118 status word.

Then, bad detection algorithm detects unreasonable data and channel dropouts. After excluding measurements containing NaNs and very small values, the following ranges are checked for voltage and current measurements:

$$0.5 \text{ p.u.} < |V_{PMU}| < 1.5 \text{ p.u.} \quad (5)$$

$$|I_{PMU}| > 10 \text{ A} \quad (6)$$

Measurements that violate conditions (5) and (6) are removed.

Data pre-screening algorithm allowed us to identify a problem with 12 voltage magnitude signals streamed by one of the entities. Measurements of less than 90 kV for 500 kV buses were received. Incorrect scaling was suspected. The pre-screening algorithm marked it as bad data. After analyzing the problem, the entity confirmed that they had some of the PMUs configured as Polar-Integer instead of Polar-Floating, which introduced scaling issues. The problem was fixed by the entity.

Data dropouts were also processed, see Figure 3-2.



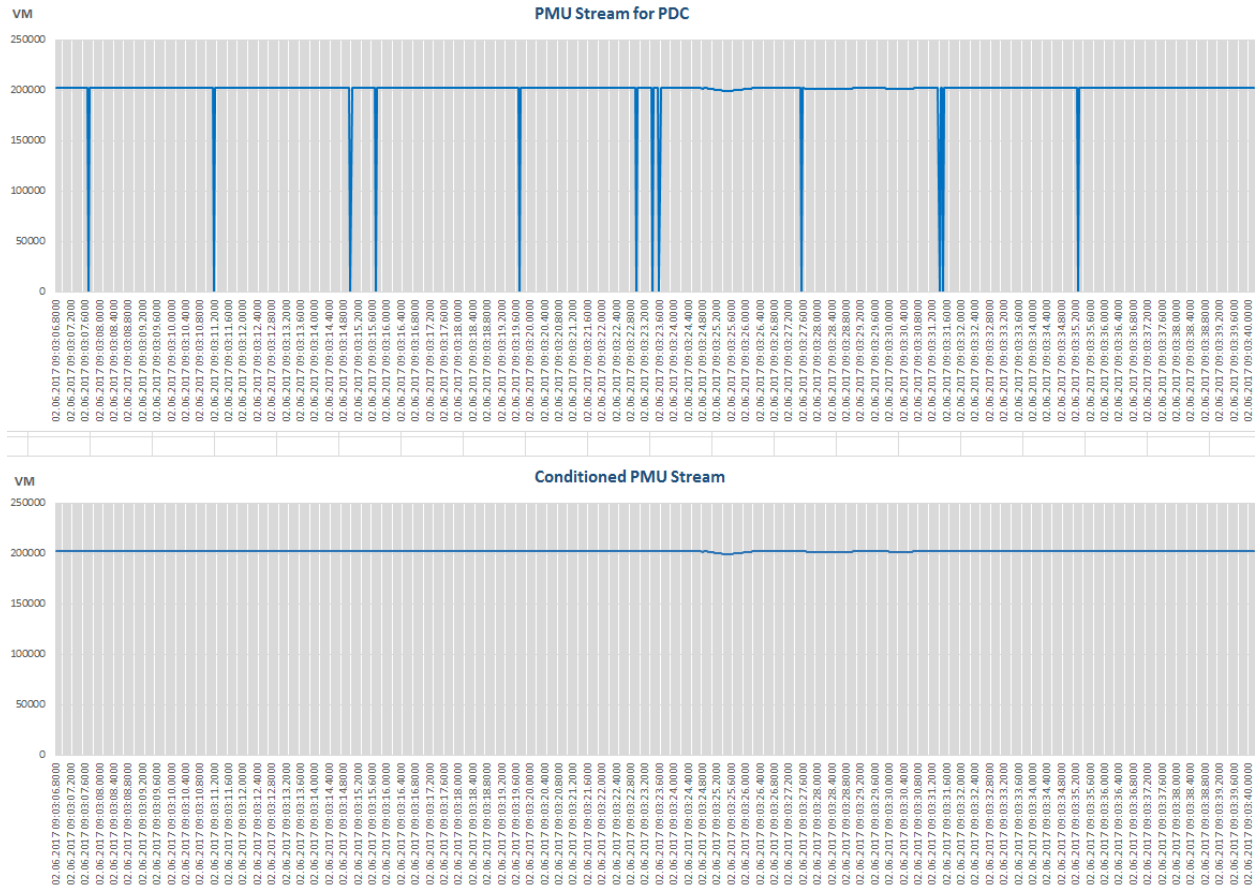

**Figure 3-2**  
Removing Data Dropouts

The data dropout removal processes handles occasional missing measurements. This is accomplished by replacing missing measurement based on the three past measurements. If more than 30% of data is missing for a particular channel, this data is considered as bad data and removed from the stream.

### 3.3 USE OF KALMAN FILTER

One of the most popular techniques in modern control theory which has been extensively used in power system applications [20-26] is Kalman filtering [22]. Kalman filtering is an algorithm that uses a series of measurements observed over time, containing statistical noise and other inaccuracies, and produces estimates of unknown variables that tend to be more accurate than those based on a single measurement alone. The Kalman filter approach is a two-stage algorithm. The first stage is *prediction*, which projects the previous time step state forward in time by means of a predefined process model. The second stage is *estimation*, which corrects the predicted state by accounting the available measurements and the accuracies of both process

model and measurements. Therefore, one of the key factors affecting the accuracy of Kalman filter is the identification of two error covariance matrices: the process noise covariance matrix, and the measurement noise covariance matrix. A two-stage Kalman filter approach for robust real-time power system state estimation was developed in [23].

The Kalman filter [22-28] is an efficient recursive filter that estimates the state of a process by minimizing the mean of the squared error when the process and measurement models are accurate and satisfy certain statistical and spectral properties.

A linear system can be modeled as a pair of linear stochastic process and measurement equations:

$$x_k = Ax_{k-1} + w_{k-1} \quad (7)$$

$$z_k = Hx_{k-1} + v_k \quad (8)$$

where

$x \in R^n$  = the system state vector;

$z \in R^m$  = the measurement vector;

$A$  =  $n \times n$  is the state transition matrix that links the system state at the previous time step  $k-1$  to the state at the current time step  $k$  ;

$H$  =  $m \times n$  matrix that relates the system state and the measurement set  $z_k$  ;

$w_{k-1} \in R^n$  = the process noise at time step  $k-1$ ; assumed to be white;

$v_k$  = measurement noise; assumed to be white.

The process noise and measurement noise are assumed to be mutually independent random variables with normal probability distributions

$$p(w) \sim N(0, Q),$$

$$p(v) \sim N(0, R),$$

where

$Q$  = the process noise covariance matrix;

$R$  = the measurement noise covariance matrix.

The Kalman filter algorithm consists of prediction and estimation equations.

The prediction equations obtain the *a priori* state estimate  $x_{\bar{k}}$  of the state  $x_k$  at time step  $k$  given the knowledge of the process prior to time step  $k$ , up to and including time step  $k-1$ . The estimation equations incorporate the new measurements obtained at time-step  $k$  into the *a priori* estimate and are used to derive an improved *a posteriori* estimate  $\hat{x}_k$  of the true state  $x_k$ .

Prediction equations are:

$$x_{\bar{k}} = \hat{x}_{k-1};$$

$$P_{\bar{k}} = P_{k-1} + Q_k$$

Estimation equations are:

$$K_k = P_{\bar{k}} H^T (H P_{\bar{k}} H^T + R_k)^{-1};$$

$$\hat{x}_k = x_{\bar{k}} + K_k (z_k - H x_{\bar{k}});$$

$$P_k = (I - K_k H) P_{\bar{k}};$$

where:

$$e_{\bar{k}} \equiv x_k - \hat{x}_{\bar{k}} = \text{a priori estimate error};$$

$$P_{\bar{k}} \equiv E[e_{\bar{k}} e_{\bar{k}}^T] = \text{a priori estimate error covariance};$$

$$e_k \equiv x_k - \hat{x}_k = \text{a posteriori estimate error};$$

$$P_k \equiv E[e_k e_k^T] = \text{a posteriori estimate error covariance};$$

$$K_k = \text{n} \times \text{m matrix that minimizes the a posteriori estimate error covariance called Kalman gain matrix.}$$

There are several enhanced implementations of the Kalman filter, for example Extended Kalman Filter and two-stage Kalman filter, [23].

Quadratic prediction based Kalman filter was used during the PRSP analysis [29]. Thus, we used quadratic relationship between the past, present and future/estimated state as shown in (9):

$$\hat{x}(k+1|k) = 3 \hat{x}(k|k) - 3 \hat{x}(k-1|k-1) + \hat{x}(k-2|k-2) \quad (9)$$

where

$$\hat{x} = \text{the estimated value of individual state } x.$$

Equation (9) is based on the assumption that for a linear increase in load at constant power factor (which holds for a power system measurement at 30 times a second); the complex voltages and currents since currents are linear functions of voltage will follow a quadratic trajectory with the next estimate depending on three previous estimates.

Figure 3-3 shows that the use of quadratic prediction based Kalman filter offers an accurate prediction (orange curve) as compared the measured values (blue curve).

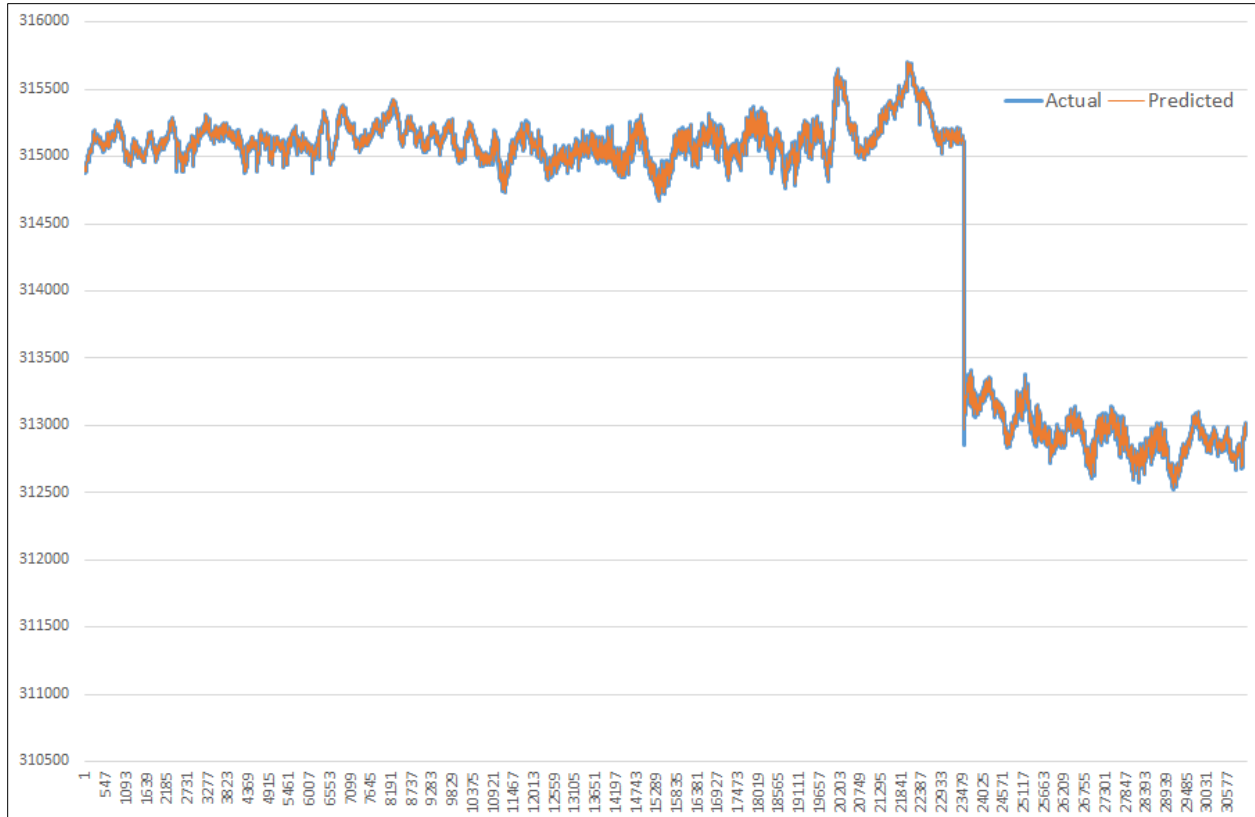

**Figure 3-3**  
**Measured vs. Predicted Values**

To perform off-line analysis, V&R energy developed a free application, **PMU Viewer**, available to all PRES P participants, see Figure 3-4.

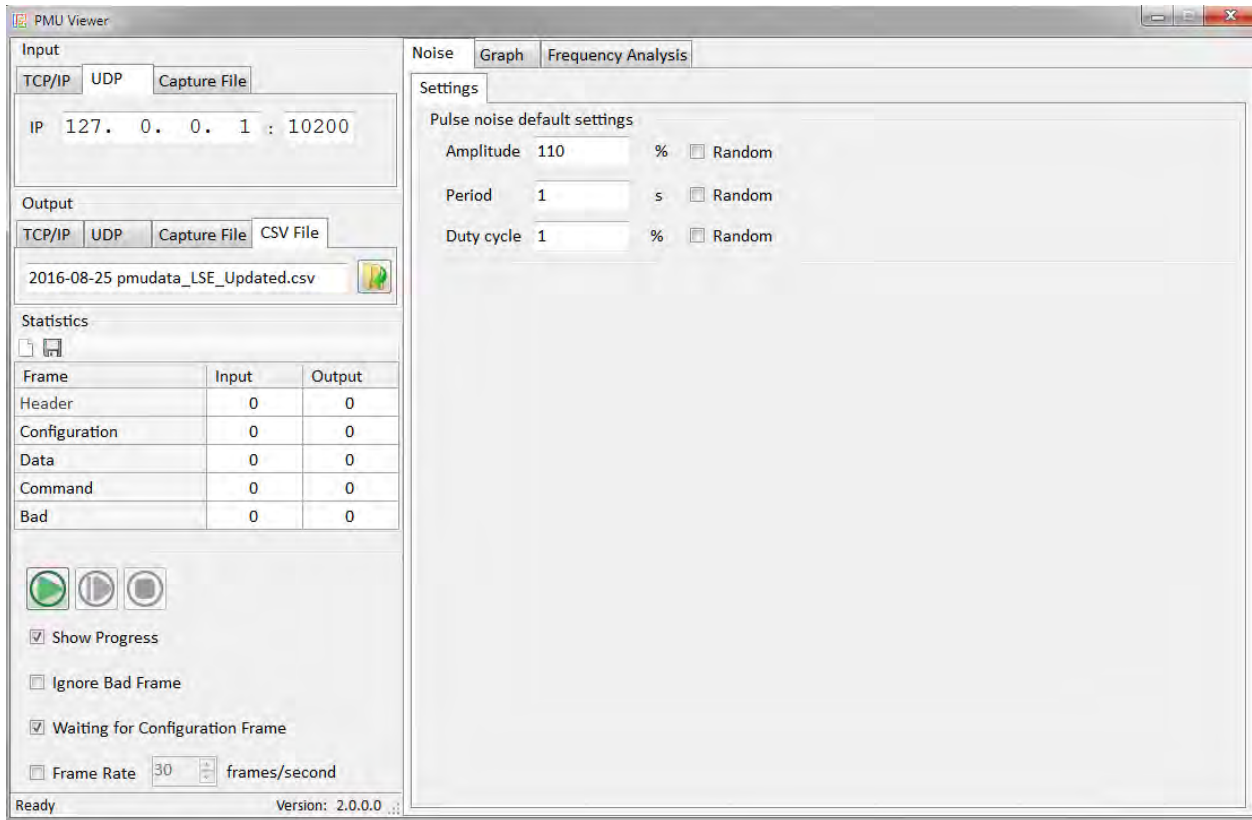

**Figure 3-4**  
**PMU Viewer Interface**

# 4.

## **LINEAR STATE ESTIMATION AND OBSERVABILITY ANALYSIS FOR CAISO, IPC, PEAK RELIABILITY, SCE, AND SDGE**

---

### **4.1 State Estimation**

State estimation is the process of deriving a “best estimate” of system state (system voltage magnitudes and phase angles) based on a set of measurements from the system. The state estimator (SE) produces a state estimate using measured quantities and statuses, such that bad data or errors are flagged through redundant measurements deriving the estimate. Usually, state estimation is based on minimizing the sum of squares of the differences between the estimated and the measured values of a function, [30-32]. There are three primary types of commonly used state estimators:

1. Conventional – non-linear state estimate based on unsynchronized SCADA measurements;
2. Hybrid – non-linear state estimate using unsynchronized SCADA measurements and time synchronized synchrophasor data;
3. PMU-based state estimator (since PMUs provide both voltage magnitude and phase angle, this is a direct linear solution of the system state). PMU-based state estimator is frequently referred to as Linear State Estimator, [33-35].

The state estimation process is summarized in Figure 4-1.

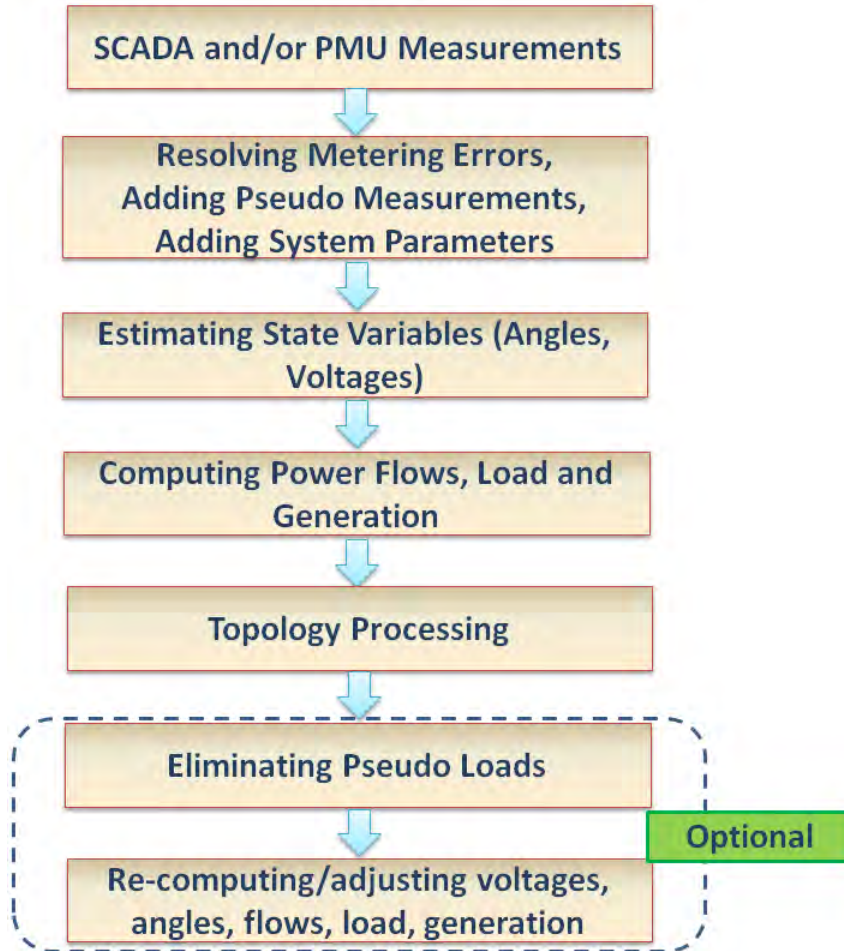

**Figure 4-1  
State Estimation Process**

The advantages of using PMUs for state estimation include:

1. Synchronized measurements with a common time reference;
2. Voltage and current phasor measurements (magnitude and phase angle) are available;
3. Speed of state estimate solution due to a direct, non-iterative technique.

PMU-based state estimator is used to improve PMU data quality, and may serve as a backup SE solution and/or comparison check for the conventional SE.

There are two approaches for linear state estimation:

1. Based on DC (linearized) model of the power system, [36];
2. Based on AC model of the power system, [37].

Under the PRSP, we are performing linear state estimation using AC model of the power system.

## 4.2 Linear State Estimation Based on DC Power System Model

Power balance equations at load and generator buses for a DC model are:

$$z_1 = H_1 x \quad (10)$$

$z_1$  is the vector of measured real powers of loads and generators;  
This can be SCADA or PMU measurements.

$x$  is the state vector of phase angles of bus voltages;

$H_1$  is the Jacobian coefficient matrix.

$H_1$  is the Jacobian coefficient matrix computed as follows:

$$H_1 = \text{Diag}V^T Y \text{Diag}V \quad (11)$$

where

$\text{Diag}V$  is the diagonal matrix of voltage magnitude measurements;  
This can be SCADA or PMU measurements.

$Y$  is the admittance matrix.

Real power flows on lines and transformers are estimated as follows:

$$z_2 = H_2 x \quad (12)$$

where

$z_2$  is the vector of measured real powers flows;  
This can be SCADA or PMU measurements;

$x$  is the state vector of phase angles of bus voltages;

$H_2$  is the matrix of a special structure, which has only two non - zero elements in each row

PMU measurements of voltage phase angles are used as follows:

$$z_3 = H_3 x \quad (13)$$

where

$z_3$  are measured voltage phase angles;  
These are PMU measurements.

$x$  is the state vector of phase angles of bus voltages;

$H_3 = (I, 0)$  is a matrix,

where

$I$  is the identity matrix;  
“0” columns are added if PMU measurements are not available.



Equations (10), (12) and (13) may be combined into one system:

$$z = \begin{pmatrix} z_1 \\ z_2 \\ z_3 \end{pmatrix} = \begin{pmatrix} H_1 \\ H_2 \\ H_3 \end{pmatrix} x = Hx \quad (14)$$

The diagonal weight matrix is:

$$D = [d_i] \quad (15)$$

Weight matrix D represents the accuracy and reliability of the measurements. For example, more dependable measurements can be assigned the weight of 10; while less dependable measurements may be assigned the value of 1.

Note that to ensure observability of the system, missing measurements are substituted with pseudo measurements with decreased weight.

If the covariance matrix of measurement errors is available, the weight matrix of measurements is equal to the inverse of covariance matrix.

Based on the method of maximum likelihood and assumption on the unbiased normally distributed meter error, we have:

$$D = K^{-1} = \begin{pmatrix} \frac{1}{\sigma_1^2} & 0 & \cdot & 0 \\ 0 & \frac{1}{\sigma_2^2} & \cdot & 0 \\ \cdot & \cdot & \cdot & \cdot \\ 0 & 0 & \cdot & \frac{1}{\sigma_n^2} \end{pmatrix}, \quad (16)$$

where

$\sigma_1^2, \dots, \sigma_n^2$  are the variances for the measurements.

Estimation of phase angles,  $x$ , is done by minimizing the sum of the squares of the differences between the measured values and state variables, e.g. minimizing the sum of the squares of the difference in the left and right parts of equation (14):

$$\min_x (Hx - z)^T D (Hx - z) \quad (17)$$

Setting gradient of expression (18) to zero and solving a system of linear equations:

$$\mathbf{H}^T \mathbf{D} \mathbf{H} \mathbf{x} = (\mathbf{H}^T \mathbf{D}) \mathbf{z} \quad (18)$$

we obtain coordinates of the vector  $\mathbf{x}$ :

$$\mathbf{x} = (\mathbf{H}^T \mathbf{D} \mathbf{H})^{-1} (\mathbf{H}^T \mathbf{D}) \mathbf{z} \quad (19)$$

From the estimated phase angles (19), we can calculate the power flowing on each branch and net generation and load at each bus, using equation (10).

The advantage of linear state estimation based on the DC power system model is the speed of state estimation due to using a direct non-iterative solution.

The disadvantages of the linear state estimation based on the DC power system model include:

- Measurement of current and reactive flows on branches are not used;
- Reactive power of loads are not estimated,
- It does not account for errors in measurements of voltage magnitude;
- Additional (e.g., pseudo) loads and generators may be added.

There are two approaches to remove pseudo loads/generators. In the first approach, the values of pseudo loads and generators are substituted with 0 values, and the power flow equations are solved using the full Newton method.

The second approach is based on QR decomposition of matrix  $\mathbf{H}' = \mathbf{D}^{\frac{1}{2}} \mathbf{H}$ . A rectangular  $m \times n$  matrix  $\mathbf{H}$ , is represented by an  $m \times m$  matrix orthogonal matrix  $\mathbf{Q}$ , and  $m \times n$  upper triangular matrix  $\mathbf{R}$ :

$$\mathbf{H}' = \mathbf{Q} \mathbf{R} = \mathbf{Q} \begin{pmatrix} r_{11} & r_{12} & \cdot & r_{1n} \\ 0 & r_{22} & \cdot & r_{2n} \\ \cdot & \cdot & \cdot & \cdot \\ 0 & 0 & \cdot & r_{kn} \\ 0 & 0 & \cdot & 0 \\ \cdot & \cdot & \cdot & \cdot \\ 0 & 0 & \cdot & 0 \end{pmatrix} \quad (20)$$

Since  $\mathbf{R}$  is a matrix with zero rows, equation (18) becomes:

$$R_x = D^{\frac{1}{2}} * z \quad (21)$$

By writing equations for real and reactive power balance for the buses where pseudo loads and generator are added such that they correspond to zero rows of matrix R, we ensure that the estimate of power at these buses is equal to zero.

### **Linear State Estimation Based on AC Power System Model**

This state estimation approach uses AC power system model:

- Each generator bus that regulates its own real power and voltage is described by real power balance equations and constant voltage magnitude at the generator bus, until the point when the generator reaches reactive power limit;
- Each load bus is described by real and reactive power balance equations.

This approach allows us to include measurements of voltage magnitude and current into the state estimation. Orthogonal component of voltage vector is considered as the state variable.

The state estimation has the following form:

$$z = \begin{pmatrix} V_R \\ V_I \\ I_R \\ I_I \end{pmatrix} = H \begin{pmatrix} V_R \\ V_I \end{pmatrix} = \begin{pmatrix} I & 0 \\ 0 & I \\ S_{RR} & S_{RI} \\ S_{IR} & S_{II} \end{pmatrix} \begin{pmatrix} V_R \\ V_I \end{pmatrix} \quad (22)$$

where

$z$  is the vector of orthogonal components of measured bus voltages and line currents.

$[V_R, V_I]$  is the state vector of real and imaginary components of bus voltages;

$[I_R, I_I]$  is the state vector of real and imaginary components of line current;

$I$  is the identity matrix;

$$S_{RR} = \frac{\partial I_R}{\partial V_R}, \quad S_{RI} = \frac{\partial I_R}{\partial V_I}, \quad S_{IR} = \frac{\partial I_I}{\partial V_R}, \quad S_{II} = \frac{\partial I_I}{\partial V_I}.$$

Since diagonal weight matrix of measurements is  $D = [d_{ij}]$  (see equation (15), then the weighted least square solution of (22) has the form:

$$\min_{\begin{pmatrix} V_R \\ V_I \end{pmatrix}} \left( H \begin{pmatrix} V_R \\ V_I \end{pmatrix} - z \right)^T D \left( H \begin{pmatrix} V_R \\ V_I \end{pmatrix} - z \right) \quad (23)$$

The estimates of the orthogonal components of bus voltages have the form:

$$\begin{pmatrix} \mathbf{V}_R \\ \mathbf{V}_I \end{pmatrix} = (\mathbf{H}^T \mathbf{D} \mathbf{H})^{-1} (\mathbf{H}^T \mathbf{D}) \mathbf{z} \quad (24)$$

From the estimated voltage magnitudes (24), we can calculate net generation and load at each bus.

Linear state estimation serves as an overall foundation for performing measurement-based analyses. The advanced applications that may be implemented based on the LSE base cases are listed in Figure 4-2 (please note that some of these applications are outside of the scope of the PRSP).

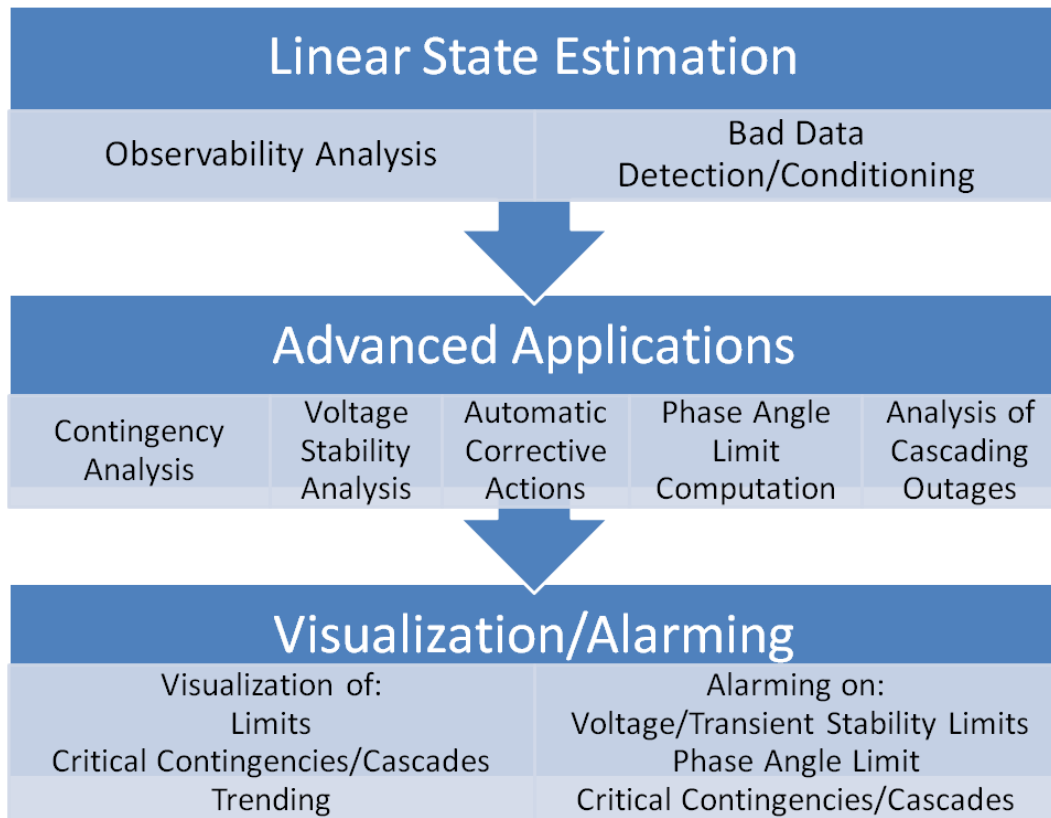

**Figure 4-2**  
**LSE as a Foundation of the Measurement-Based Analyses**

### 4.3 Bad Data Detection and Conditioning using Linear State Estimation

Linear state estimation (LSE) is a useful tool for topology processing and bad data detection, including:

- Bad PMU data;
- Bad SCADA data;
- Bad system parameters;
- Errors in the process of conventional state estimation;
- Separating bad data with an onset of an event.

LSE maybe also used for topology estimation, if breaker status is not available.

Measurement redundancy is required for bad detection and conditioning. This means that a single PMU estimating the bus voltage magnitude and angle of an adjacent bus (through direct power flow equation) is not sufficient to determine if that data (and estimate) is good or bad; however, redundancy provides a comparison between measurements to identify which measurements can be flagged as bad.

Bad PMU data detection is done using a combination of two approaches:

- Heuristic (logical) rules;
- Statistical methods.

Please note that data pre-screening described in Section 3 is performed first. This prevents bad data from being used in a subsequent step, linear state estimation. It detects data loss and marks the bad data in the raw data set. Bad data detection approaches presented in Section 3 do not attempt to re-condition the detected bad data.

#### 4.3.1 Using Heuristic Methods

Heuristic methods that are applied as the next step, before the execution of the LSE, include:

- Checking for physical law violations (e.g. Kirchhoff law violations),
- Detecting inconsistency between different measurement data (e.g. active and reactive power of a line does not agree with phase angle measurement data).

Some of the rules included in the heuristic analysis are:

- Real power computed using measured voltage and current at the From side should be greater than at the To side;
- Comparing with and considering previous measurements;
- Detecting and correcting data based on availability of measured data.

Example:

Currents are measured on all lines at bus A, see Figure 4-3. They are significantly non-zero and satisfy Kirchoff law

$$I_1 + I_2 + I_3 + I = 0.$$

However,  $I = 0$  at another end of the line.

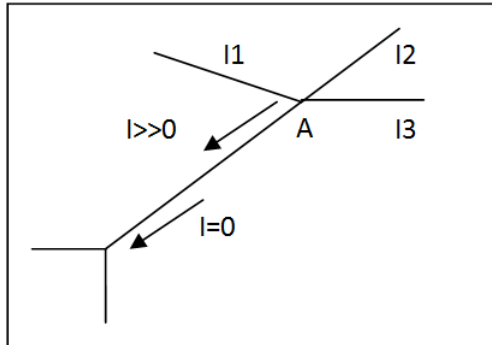

**Figure 4-3**  
**An Example of Using Heuristic Rules**

Then, we can detect this bad measurement and estimate the value of current at this end of the line.

Linear state estimation is then performed, at the synchrophasor data rate, for locations with sufficient PMU coverage (local redundancy). Heuristic and statistical methods are applied to identify suspected bad data points and topology changes. As a result, the estimated values will be used as the re-conditioned data for those detected bad data points.

The statistical methods are applied to the results of the LSE output, such as the chi-square criterion. When few measurements show large residual differences, they are marked as suspected bad data. Signal with the largest residual is removed and the state estimation process is repeated. The data with the highest residual value is removed until the maximum residual is under a given user-defined tolerance (default is 25%).

If a large number, or majority of, measurements show large residual differences, topology mismatch of the system model will be suspected. If, as a result of statistical computation, too many measurements should be excluded or the sum of the squares of the differences between the measured values and state variables cannot be minimized, parameters of the network model used in SE significantly differ from the actual system parameters. Then, parameters should be adjusted based on measurements. In some cases, they can be recomputed directly using the PMU measurements.

### 4.3.2 Topology Estimation Using PMU Measurements

A sample substation is given in Figure 4-4.

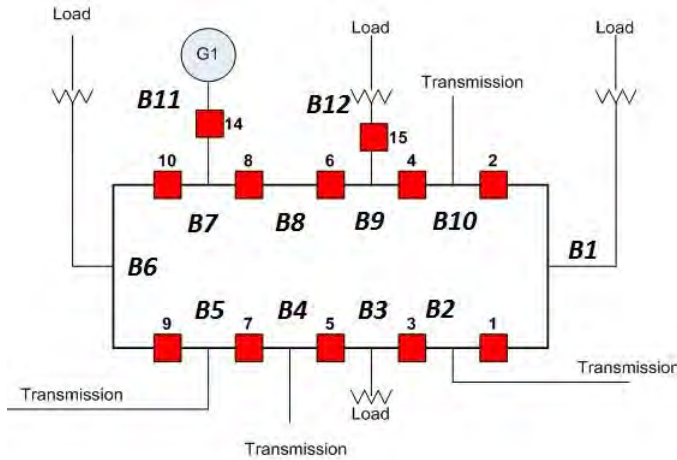

**Figure 4-4**  
A Sample Substation Configuration with PMUs Installed

PMU locations within a substation are shown in Figure 4-5:

- PMUs 1, 2, and 3 are at breakers 7, 8 and 14, respectively;
- PMUs 4 and 5 are on line sections.

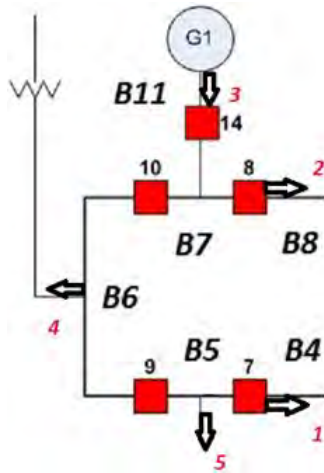

**Figure 4-5**  
Five PMUs at a Substation

The 1<sup>st</sup> Kirchhoff law is used to estimate breaker status. The relationship between measured currents and breaker currents is

$$\begin{pmatrix} I_{M1} \\ I_{M2} \\ I_{M3} \\ I_{M4} \\ I_{M5} \\ 0 \end{pmatrix} = \begin{pmatrix} 1 & 0 & 0 & 0 & 0 \\ 0 & 1 & 0 & 0 & 0 \\ 0 & 0 & 1 & 0 & 0 \\ 0 & 0 & 0 & -1 & 1 \\ -1 & 0 & 0 & 1 & 0 \\ 0 & -1 & 1 & 0 & -1 \end{pmatrix} \begin{pmatrix} I_7 \\ I_8 \\ I_{14} \\ I_9 \\ I_{10} \end{pmatrix}$$

or

$$I_M = A I$$

Breaker current I is calculated as:

$$\min_I (I_M - A I)^T (I_M - A I)$$

Then,

$$I = (A^T A)^{-1} A^T I_M$$

If

$$I_M^T = (1 \ 1 \ 4 \ 3 \ -1 \ 0) \quad I^T = (1 \ 1 \ 4 \ 0 \ 3)$$

then breakers 7, 8, 10 and 14 are closed, and breaker 9 is open.

In case a measurement exists (e.g., non-zero), then determining an error is based on a number of methods, including weight factors and correlation analysis.

#### 4.4 Observability Analysis

Observability analysis identifies portions of the system observable using PMU measurements. Since voltages are state variables for the steady-state model of a power system network, the definition of the observability used under the PRSP is:

*A power system network is considered to be observable if voltage vector at each node can be calculated based on the PMU measurements.*



## 4.4.1 Creating an Observable Island

This example illustrates how a power system model can be generated using PMU measurements and linear state estimation (LSE) techniques.

This network is a “radial-type” load pocket consisting of voltage transformations, reactive resources, and a transmission network. PMUs are located at six buses – the majority, but not all, of the network is observable. Two equivalent generators, identified as “SYSTEM”, represented this network’s connection to the larger bulk power system. Figure 4-6 shows the PMU placement for this test system.

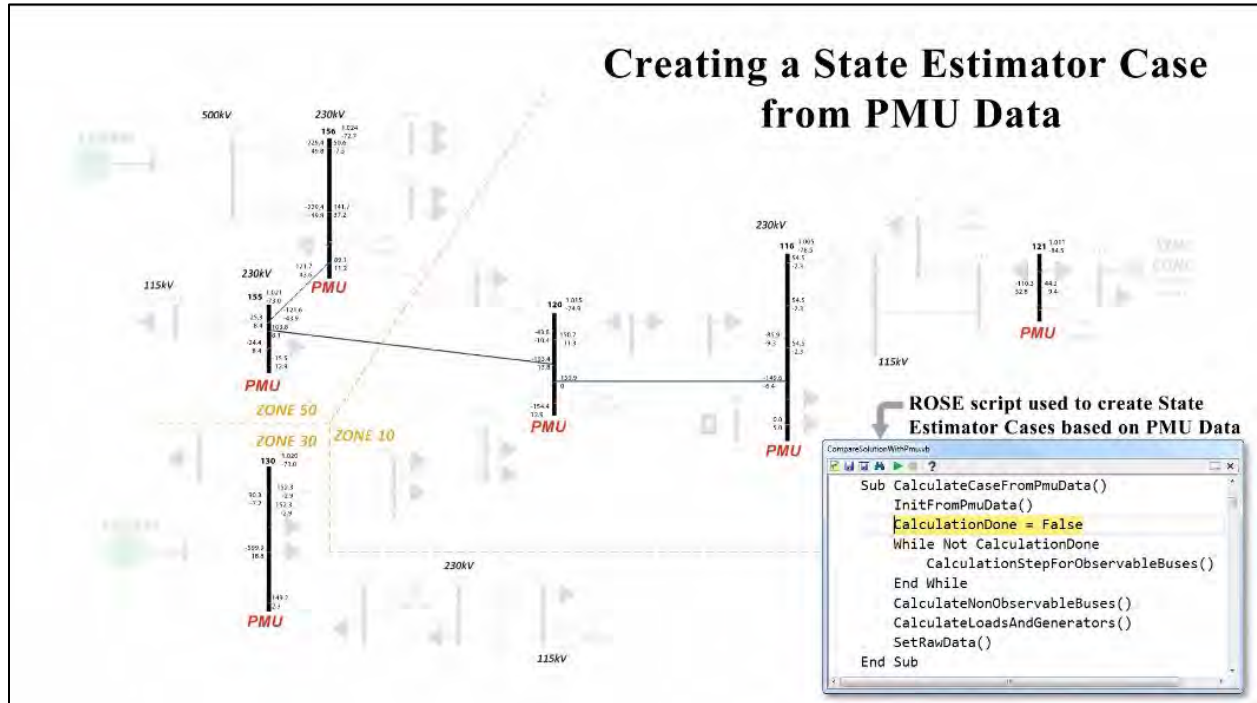

**Figure 4-6**  
**Six PMU Locations in the System**

The following steps are taken to perform observability analysis and generate a network model using the PMU data:

- Step 0 – Buses where PMUs are placed have a directly measured system state – these are fully observable, see Figure 4-6.
- Step 1 – Starting from buses where PMU measurements are located, line flows are used to estimate bus voltages at buses which are directly connected to the buses with PMUs, see Figure 4-7. These are also observable buses.

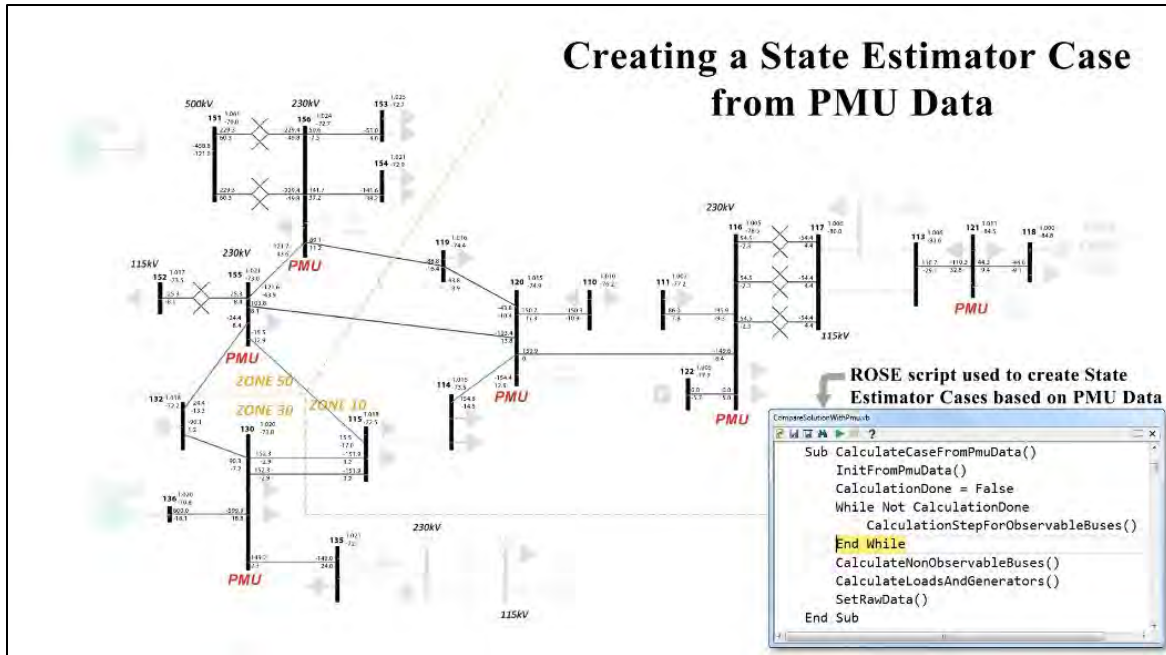

**Figure 4-7**  
**Step 1: Computing Flows and Voltages at Buses Connected to the Buses with PMUs**

- Step 2 – Compute flows and voltages at buses connected to those buses where voltages and flows have been calculated. These are also observable buses. This process is repeated while we can expand the set of observable buses, and depends on the power system network, and quantity and locations of PMUs, see Figure 4-8.

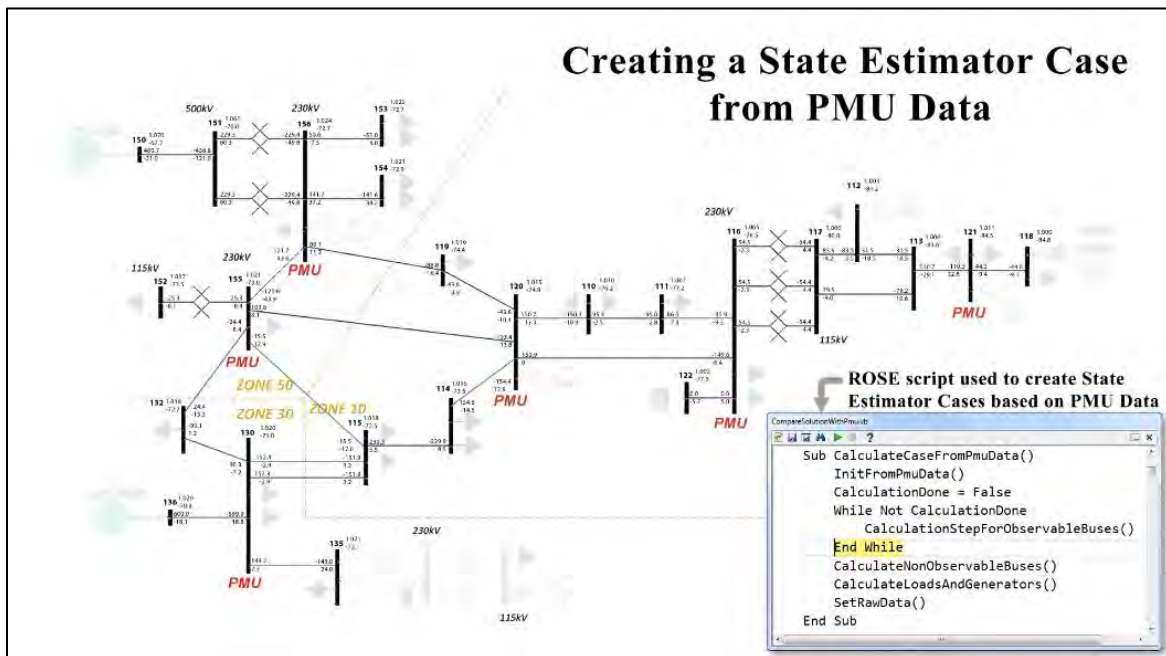

**Figure 4-8**  
**Step 2: Expanding the Set of Observable Buses**

- Step 3 – As a result of the above two steps, we (1) determine bus voltages and flows in the observable part of the system, and (2) identify non-observable parts of the network where approximate values of voltages and flows are determined, Figure 4-9.

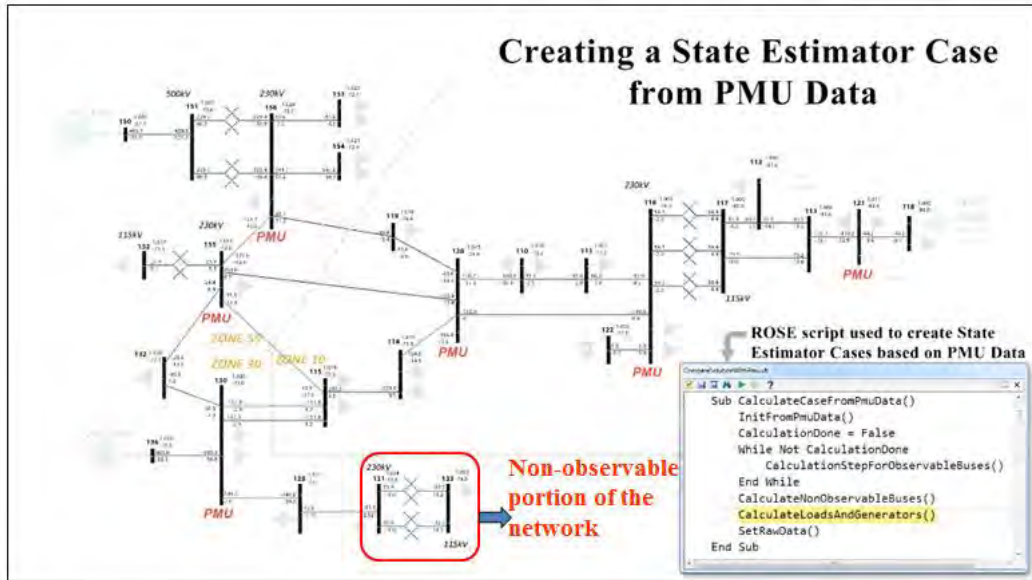

Figure 4-9  
Step 3: Identifying Non-Observable Parts of the Network

- Step 4 – Values of generation and loads and positions of switched shunts are computed, see Figure 4-10.

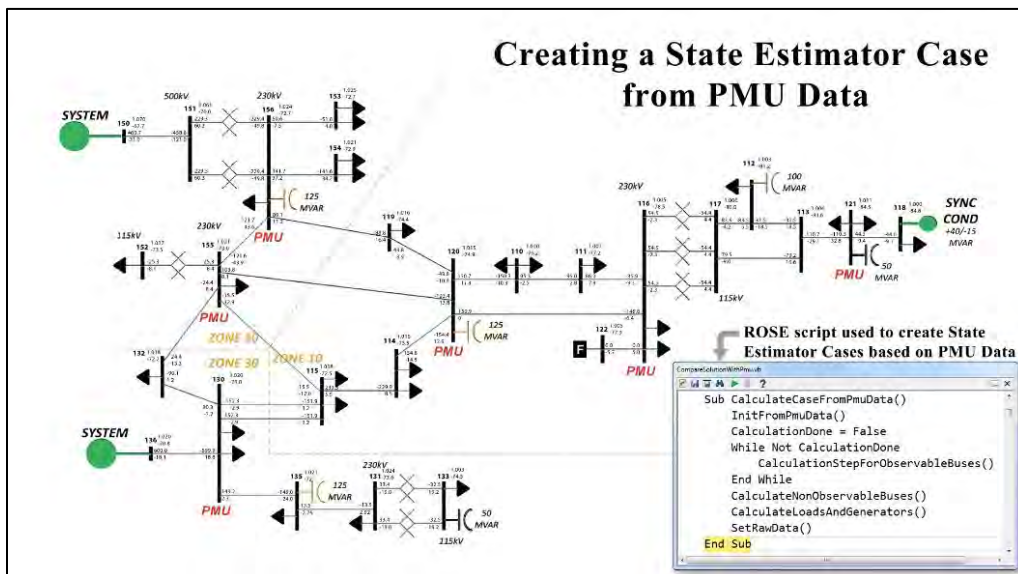

Figure 4-10  
Step 4: Creating a 26-Bus Model Using 6 PMUs

As a result, two types of measurements can be obtained from PMUs: (1) direct measurements - the PMU bus voltage phasor and current phasor from PMU bus and (2) measurements computed from direct measurements using Ohm's and Kirchhoff's laws.

#### **4.4.2 PMU/State Estimator Mapping**

To perform observability analysis, the following data was used:

- PMU data;
- State Estimator data (which includes system topology);
- PMU/State Estimator mapping file.

The results of observability analysis change when system topology change or a PMU signal is lost.

According to PRSP project participants, PMU signal mapping is a quite broad task and requires continuous maintenance due to changes in the state estimator model and addition of new PMUs. Access to the synchrophasor system equipment and documentation is critical to the success of the PMU mapping. For example, the PMU signal mapping and data validation process at Idaho Power started at the PMUs and moved towards the data concentrator device and the synchrophasor data storage platform. Verification of the PMU's AC and DC connections as well as the device programming was deemed the best place to start the process. Single Line diagrams, AC schematics, and DC schematics or as some call them Control schematics were collected for each PMU.

For correct PMU/SE mapping, it is important to identify the nodes in the SE model where the PTs and CTs exist and most closely represents the real world.

In some cases, it is needed to verify the correct line model with the SCADA display, validating the PMU current.

PMU owners should coordinate mapping with their ISOs/regional organizations to insure that both entities use the same mapping.

PRSP participants spent extensive effort to validate and improve their PMU mapping to the State Estimator models.

Automatic checking of the accuracy of the PMU/SE mapping is performed from the GOMCA Tab on the POM/ROSE interface, see Figure 4-11.

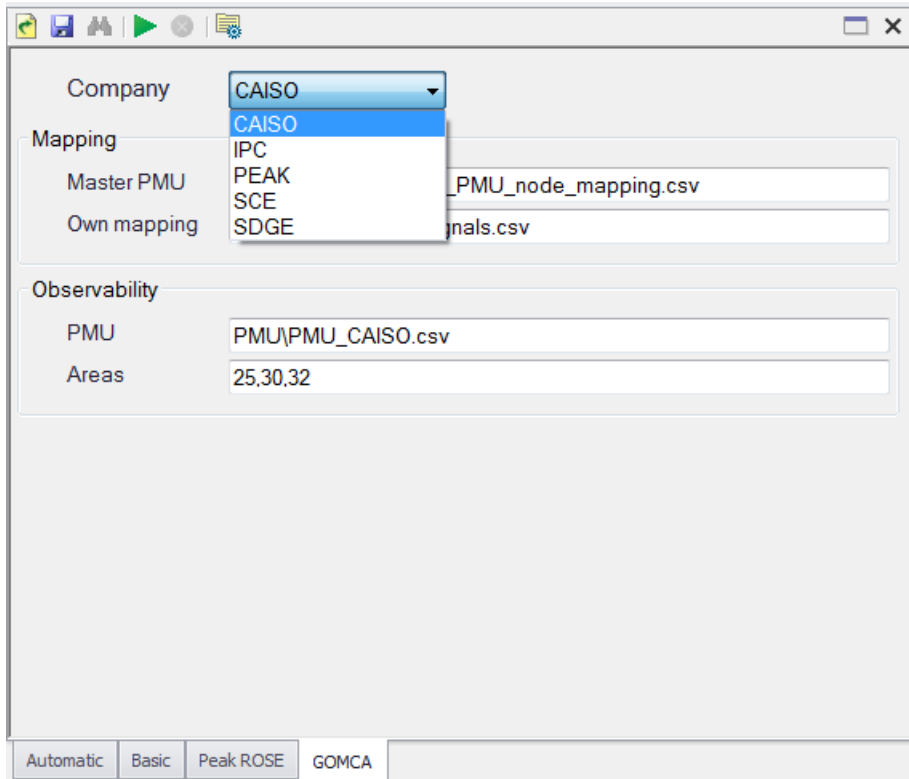
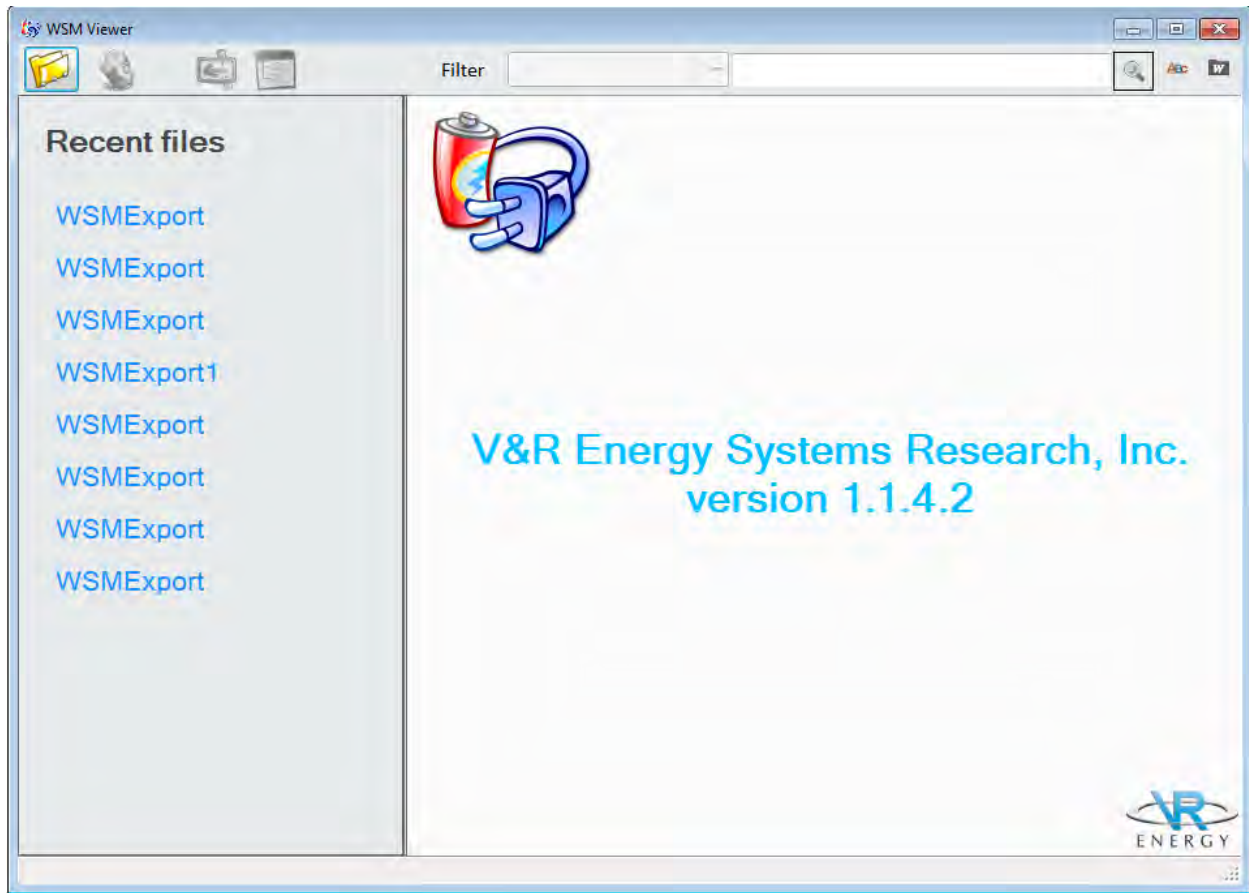

**Figure 4-11**  
**GOMCA Interface for Automatic Checking of PMU/SE Mapping**

GOMCA creates several reports indicating errors in PMU/SE mapping and listing discrepancies between the entity’s mapping and mapping in Peak’s master PMU/SE file.

Observability analysis is also accessible through GOMCA interface, see Figure 4-11.

To facilitate PMU/SE mapping, V&R Energy developed a free software tool available to all PRSP participants, **WSMViewer**, see Figure 4-12. **WSMViewer** tool is intended for easy viewing and grouping of elements in WSM (West-Wide System Model) file. This information is useful to create and/or check PMU/SE mapping.



**Figure 4-12**  
**WSMViewer Splash Screen**

### 4.4.3 Results for PRSP Participants

This Section summarizes results of observability analysis for PRSP participants.

The results of observability analysis for a particular PMU and SE data snapshot are given in Table 4-1.

**Table 4-1**  
**Summary of Results of Observability Analysis**

	Number of Buses in SE Case	Observable Buses		Observable Branches	Number of Observable Islands	Number of PMU Signals Used for Observability
		Number of Buses	% of Buses in SE Case			
<b>Entity 1</b>	23628	600	2.5	811	27	951
<b>Entity 2</b>	6250	209	3.3	293	10	306
<b>Entity 3</b>	1693	62	3.6	115	2	126
<b>Entity 4</b>	495	58	11.7	75	4	81
<b>Entity 5</b>	525	54	10.3	78	2	146

Table 4-1 shows that there is no linear dependence between the number of PMU signals and the number of observable buses. For example, using 81 signals we identified 58 observable buses in Entity 4, while 54 buses are observable using 146 for Entity 5. This example demonstrates that not only the number of PMU signals, but also locations of PMU installations and network topology play significant role in observability analysis.

There are 27 observable islands ranging from 1 to 213 observable buses in the Entity 1 system, see Table 4-2.

**Table 4-2**  
**Entity 1: Twenty Seven Observable Islands**

Observable Buses	Observable Branches	PMU Signals
8	13	8
9	10	11
7	11	13
13	22	29
11	17	19
198	287	318
213	297	369
2	4	2
6	6	7
4	3	5
3	2	3
19	21	27
42	56	65
4	3	5
2	2	2
3	2	3
13	14	19
1	0	1
3	3	6
4	3	6
4	3	5
3	3	3
4	7	8
6	6	4
3	2	2
2	1	2
13	13	9
<b>600</b>	<b>811</b>	<b>951</b>



Distribution of observable buses by nominal voltage for Entity 1 is shown in Table 4-3.

**Table 4-3**  
**Entity 1: Distribution of Observable Buses by Nominal Voltage**

Observable Buses by kV	
Voltage Class, kV	Number of Buses
500 kV	179
400 kV	4
345 kV	38
287 kV	6
240 kV	16
230 kV	209
138 kV	14
132 kV	1
120 kV	2
115 kV	12
< 100 kV	119
TOTAL	600

Percentage of observable buses by their nominal voltage is given for Entity 1 in Figure 4-13.

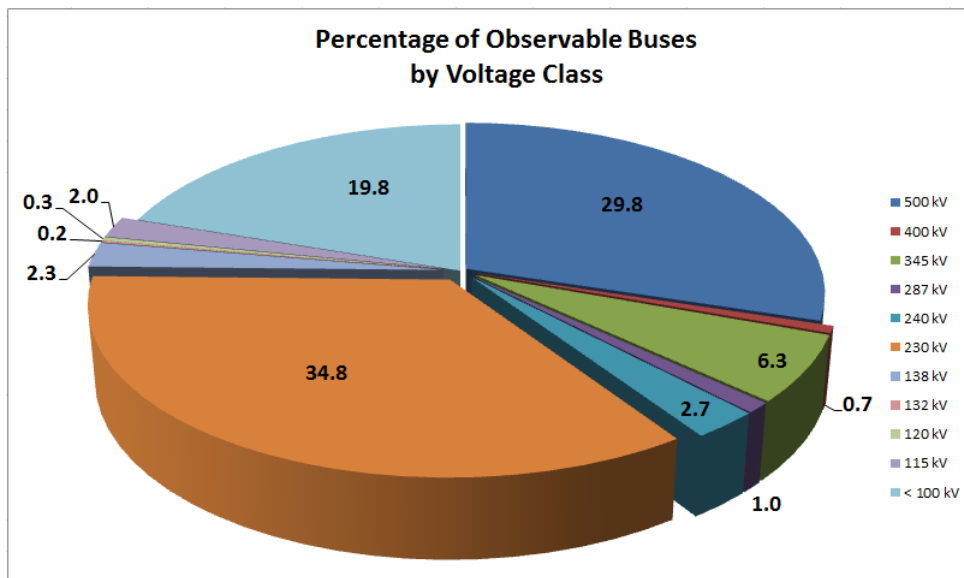

**Figure 4-13**  
**Entity 1: Percentage of Observable Buses by Nominal Voltage**



There are 10 observable islands ranging from 1 to 79 observable buses in the Entity 2 system, see Table 4-4.

**Table 4-4**  
**Entity 2: Ten Observable Islands**

Observable Islands	Observable Buses	Observable Branches	PMU Signals
1	79	98	90
2	4	6	10
3	23	30	35
4	9	9	13
5	3	2	4
6	71	127	134
7	4	7	8
8	1	0	1
9	2	1	2
10	13	13	9
<b>TOTAL</b>	<b>209</b>	<b>293</b>	<b>306</b>

Distribution of observable buses by nominal voltage is shown for Entity 2 in Table 4-5.

**Table 4-5**  
**Entity 2: Distribution of Observable Buses by Nominal Voltage**

Observable Buses by kV	
Voltage Class, kV	Number of Buses
500 kV	80
345 kV	10
230 kV	54
115 kV	1
< 100 kV	64
<b>TOTAL</b>	<b>209</b>

Percentage of observable buses by their nominal voltage is given for Entity 2 in Figure 4-14.

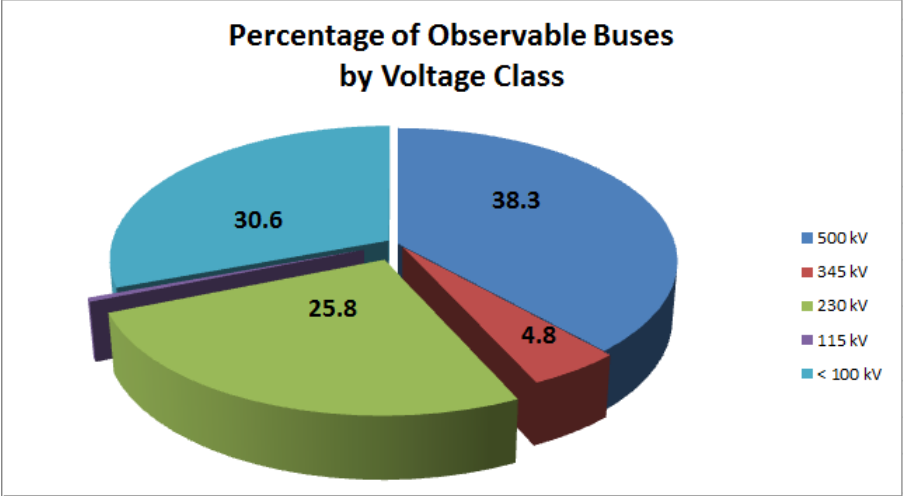

**Figure 4-14**  
**Entity 2: Percentage of Observable Buses by Nominal Voltage**

There are two observable islands in the Entity 3 system, see Table 4-6.

**Table 4-6**  
**Entity 3: Two Observable Islands**

Observable Islands	Observable Buses	Observable Branches	PMU Signals
1	58	108	118
2	4	7	8
<b>TOTAL</b>	<b>62</b>	<b>115</b>	<b>126</b>

Distribution of observable buses by nominal voltage is shown for Entity 3 in Table 4-7.

**Table 4-7**  
**Entity 3: Distribution of Observable Buses by Nominal Voltage**

Observable Buses by kV	
Voltage Class, kV	Number of Buses
500 kV	8
230 kV	31
115 kV	1
< 100 kV	22
<b>TOTAL</b>	<b>62</b>

Percentage of observable buses by their nominal voltage is given for Entity 3 in Figure 4-15.

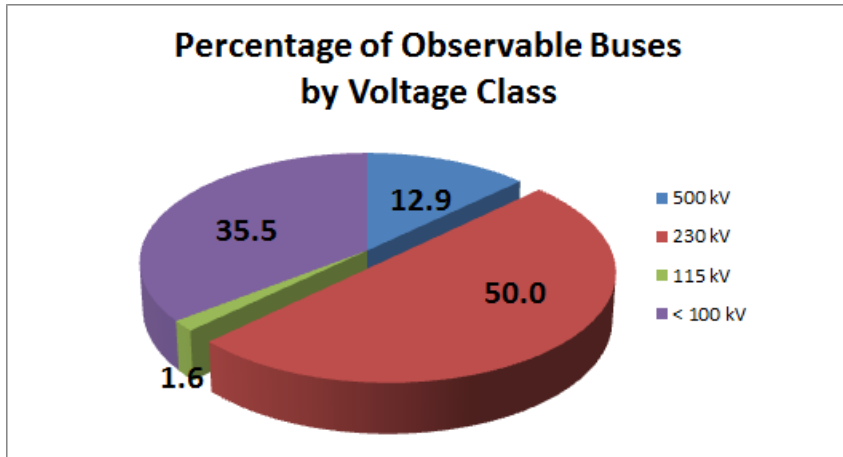

**Figure 4-15**  
**Entity 3: Percentage of Observable Buses by Nominal Voltage**

There are two observable islands in the Entity 4 system, see Table 4-8.

**Table 4-8**  
**Entity 4: Two Observable Islands**

Observable Islands	Observable Buses	Observable Branches	PMU Signals
1	46	62	67
2	5	6	5
3	5	6	7
4	2	1	2
<b>TOTAL</b>	<b>58</b>	<b>75</b>	<b>81</b>

Distribution of observable buses by nominal voltage is shown for Entity 4 in Table 4-9.

**Table 4-9**  
**Entity 4: Distribution of Observable Buses by Nominal Voltage**

Observable Buses by kV	
Voltage Class, kV	Number of Buses
500 kV	3
345 kV	10
230 kV	33
138 kV	3
< 100 kV	9
<b>TOTAL</b>	<b>58</b>

Percentage of observable buses by their nominal voltage is given for Entity 4 in Figure 4-16.

**Figure 4-16**  
**Entity 4: Percentage of Observable Buses by Nominal Voltage**

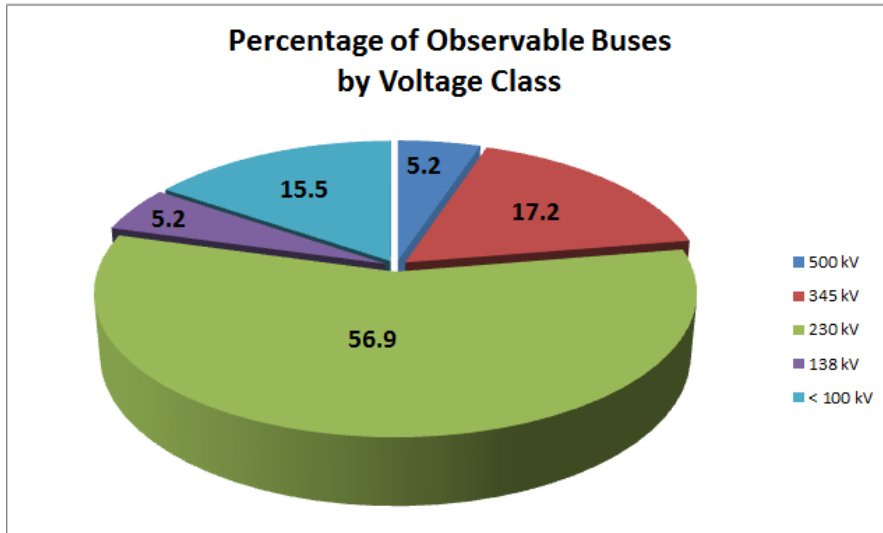

There are two observable islands in the Entity 5 system, see Table 4-10.

**Table 4-10**  
**Entity 5: Two Observable Islands**

Observable Islands	Observable Buses	Observable Branches	PMU Signals
1	48	72	141
2	6	6	5
<b>TOTAL</b>	<b>54</b>	<b>78</b>	<b>146</b>

Distribution of observable buses by nominal voltage is shown in Table 4-11.

**Table 4-11**  
**Entity 5: Distribution of Observable Buses by Nominal Voltage**

Observable Buses by kV	
Voltage Class, kV	Number of Buses
500 kV	9
230 kV	33
138 kV	2
< 100 kV	10
<b>TOTAL</b>	<b>54</b>

Percentage of observable buses by their nominal voltage is given in Figure 4-17.

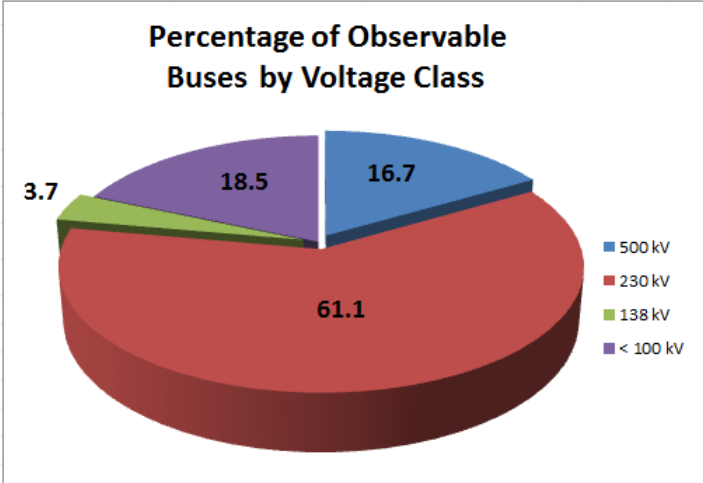

**Figure 4-17**  
**Entity 5: Percentage of Observable Buses by Nominal Voltage**

# 5.

## LESSONS LEARNED: PMU DATA VALIDATION, BY IDAHO POWER COMPANY

---

Data validation for the PRSP is quite broad and can be very extensive tasks depending upon the number of PMUs, PDCs, the documentation, and the storage systems in place for the synchrophasor data. Access to the equipment and documentation is critical to the success of the data validation piece of the PRSP.

The data validation process at Idaho Power Co. (IPC) started at the PMUs and moved towards the storage device. Verification of the PMU connections and programming were deemed the most critical and were also the most time consuming piece of the data verification.

1. The PMU's AC/DC connections were reviewed. For PMU's with multiple current and voltage inputs the device name was of particular concern as well as the CT and PT ratios. In addition, the PMU programming, i.e. Messages per second, type of signals, etc. were reviewed.
2. The PDC receiving the PMU signal was reviewed to ensure that the signal was renamed as per the WECC signal naming convention and that signal received was the correct signal. The PMU data stream was monitored in the PDC to determine whether or not the data stream was reliable.
3. The PDC programming was reviewed to ensure the composite data streams contained the correct signals and sent to the appropriate location. Not all of the data streams are being sent to Peak Reliability, i.e., such some 69 kV stations.
4. The storage device, in this case OpenPDC, was reviewed to ensure the signal mapping was correct and that the PDC data was being stored as desired.
5. The data retrieval process from the OpenPDC was tested to verify that requested data could be retrieved on demand.
6. The Synchrophasor was matched with the WSM base case equipment.

The above steps were processed by IPC to improve synchrophasor system accuracy of its Synchrophasor data network. These steps have exposed several problems in each step. The work focused on correcting the exposed data errors.

# 6.

## REFERENCES

---

- [1] Nuki, R.F. and Phadke, A.G., “Phasor measurement placement techniques for complete and incomplete observability”, IEEE Transactions on Power Delivery, Vol. 20, No. 4, October 2005, pp. 2381–2388.
- [2] Abur, A. “Optimal placement of phasor measurements units for state estimation”, PSERC Publication 06-58, October 2005.
- [3] Lopes T. “Estimadores de estado em sistemas de energia elétrica incluindo restrições fuzzy,” PhD Thesis, Universidade Federal do Rio de Janeiro, Rio de Janeiro, 2008. [Online]. Available at: <http://www.pee.ufrj.br/teses/textocompleto/2008063002.pdf>.
- [4] Srihari Mandava, Vanishree J, Ramesh V. “A Spanning Tree Approach in Placing Multi-channel and Minimum Channel PMU’s for Power System Observability”, International Journal of Electrical and Computer Engineering (IJECE) ,Vol. 5, No. 3, June 2015, pp. 518~524.
- [5] N. Theodorakatos, N. Manousakis, G. Korres, “Optimal PMU Placement Using Nonlinear Programming”, OPT-i An International Conference on Engineering and Applied Sciences Optimization, M. Papadrakakis, M.G. Karlaftis, N.D. Lagaros (eds.) Kos Island, Greece, 4-6 June 2014, Jun 2014, Kos Island Greece, Greece. 2014. <hal-01178321v2>.
- [6] G. R. Krumpholz, K. A. Clements and P. W. Davis, “Power system observability: a practical algorithm using network topology”, IEEE Trans. Power Apparatus and Systems, Vol. PAS-99, No. 4, pp. 1534-1542, July/Aug. 1980.
- [7] F.F. Wu, A. Monticelli, “Network Observability: Theory,” IEEE Transactions on Power Apparatus and Systems, Vol. 104, Issue 5, pp.1042-1048, May 1985.
- [8] S. L. Ramírez-P. and C. A. Lozano. “Comparison of PMU placement methods in power systems for voltage stability monitoring Ing. Univ., vol. 20, no. 1, pp. 23-43, 2016. <http://dx.doi.org/10.11144/Javeriana.iyu20-1.cppm>.
- [9] A.G. Phadke, J.S. Thorp. Synchronized Phasor Measurements and Their Applications. Springer. 2008.
- [10] A. El-Zonkoly, S. El-Safty, R. Maher, “Optimal placement of PMUs using improved Tabu search for complete observability and out-of-step prediction”. Turkish Journal of Electrical Engineering & Computer Sciences. Published Online: 12.08.2013. pp. 1378-1393. 2013.
- [11] F. Glover, “Tabu Search - Part 1”, ORSA Journal on Computing, Vol. 1, pp. 190-206, 1989.
- [12] F. Glover, “Tabu Search: Part 2”, ORSA Journal on Computing, Vol. 2, pp. 4-32, 1990.

- [13] B. Milosevic, M. Begovic, “Non-dominated Sorting genetic algorithm for optimal phasor measurement placement”, IEEE Transaction on Power systems, Vol. 18, No. 1, (Feb. 2003), pp. 69-75.
- [14] D. Dua, S. Dambhare, R. K. Gajbhiye, and S.A. Soman, “Optimal multistage scheduling of PMU placement: an ILP approach,” IEEE Trans. Power Del., vol. 23, no. 4, pp.1812-1820, Oct 2008.
- [15] B. Shayanfard, M. Dehghani, and A. Khayatian. “Optimal PMU Placement for Full Observability and Dynamic Stability Assessment”. 2011 19th Iranian Conference on Electrical Engineering, pp. 1-6, May 2011.
- [16] *IEEE Standard for Synchrophasor Measurements for Power Systems*, IEEE PES Power System Relaying Committee, IEEE Std C37.118.1™-2011, December 2011.
- [17] *IEEE Standard for Synchrophasor Data Transfer for Power Systems*, IEEE PES Power System Relaying Committee, IEEE Std C37.118.2™-2011, December 2011.
- [18] A. Blood, M. D. Ilic, J. Ilic, and B. H. Krogh, “A Kalman filter approach to quasi-static state estimation in electric power systems,” in Proc. of the 38th North American Power Symposium, 2006 (NAPS 2006), 17-19 Sept.2006, Carbondale, IL, USA, pp. 417–422.
- [19] E. A. Blood, B. H. Krogh, and M. D. Ilic, “Electric power system static state estimation through Kalman filtering and load forecasting,” in Proc. of the IEEE PES General Meeting–Conversion and Delivery of Electrical Energy in the 21st Century, Pittsburgh, PA, USA, Hawaii, USA, July 20-24, 2008, pp. 1–6.
- [20] I. Kamwa, S. R. Samantaray, and G. Joos, “Wide frequency range adaptive phasor and frequency PMU algorithms,” IEEE Trans. Smart Grid, vol. 5, no. 2, pp. 569-579, Mar. 2014.
- [21] I. Kamwa, S. R. Samantaray, and G. Joos, “Optimal integration of disparate C37.118 PMUs in wide-area PSS with electromagnetic transients,” IEEE Trans. Power Syst., vol. 28, no. 4, pp. 4760-4770, Nov. 2013.
- [22] R. E. Kalman, “A new approach to linear filtering and prediction problems,” J. Basic Eng. Trans. ASME, Series D, vol. 82, pp. 35-45, Mar. 1960.
- [23] J. Zhang, G. Welch, G. Bishop, and Z. Huang, “A two-stage Kalman filter approach for robust and real-time power system state estimation,” IEEE Trans. Sustain. Energy, vol. 5, no. 2, pp. 629-636, Apr. 2014.
- [24] G. Welch and G. Bishop, “An introduction to the Kalman filter,” TR 95-041, Dep. of Computer Science, University of North Carolina, USA, July 2006
- [25] G. Valverde, V. Terzija, “Unscented kalman filter for power system dynamic state estimation,” IET Generation, Transmission & Distribution, vol. 5, No 1, pp. 29 - 37, 2011.
- [26] S. Sarri, M. Paolone, R. Cherkaoui, A. Borghetti, F. Napolitano, C.A.Nucci, “State estimation of active distribution networks: comparison between WLS and iterated Kalman-filter algorithm integrating PMUs”, Innovative Smart Grid Technologies (ISGT Europe), 2012.



- [27] F. Gao, J. S. Thorp, A. Pal, and S. Gao, "Dynamic state prediction based on auto-regressive (AR) model using PMU data," in Proc. IEEE Power and Energy Conference at Illinois, Champaign, IL, pp. 1-5, Feb. 2012.
- [28] M. Pignati, L. Zanni, S. Sarri, R. Cherkaoui, J. Le Boudec, M. Paolone, "A pre-estimation filtering process of bad data for linear power systems state estimators using PMUs", 18th Power Systems Computation Conference (PSCC), August 2014, DOI: 10.1109/PSCC.2014.7038329.
- [29] Jones, K. D., Pal, A., & Thorp, J. S. (2015). Methodology for Performing Synchrophasor Data Conditioning and Validation. IEEE Transactions on Power Systems, 30(3), 1121-1130. [6889046]. DOI: 10.1109/TPWRS.2014.2347047
- [30] D. Marquardt, "An Algorithm for Least-Squares Estimation of Nonlinear Parameters". SIAM Journal on Applied Mathematics 11 (2), pp. 431–441, 1963.
- [31] K. Levenberg, "A Method for the Solution of Certain Non-Linear Problems in Least Squares". Quarterly of Applied Mathematics 2, pp. 164–168, 1944.
- [32] A. Abur and A. Exp'osito, Power System State Estimation: Theory and Implementation, ser. Power Engineering (Willis). Taylor & Francis, 2004.
- [33] A. G. Phadke and J. S. Thorp, "Synchronized Phasor Measurements and Their Applications", New York, NY, USA, Springer. 2008.
- [34] A. G. Phadke, J. S. Thorp, and K. J. Karimi, "State estimation with phasor measurements," IEEE Trans. Power Syst., vol. 1, no. 1, pp. 233-238, Feb. 1986.
- [35] K. D. Jones, J. S. Thorp, and R. Gardner, "Three-phase linear state estimation using phasor measurements," in Power and Energy Society General Meeting (PES), 2013 IEEE, 2013, pp. 1–5.
- [36] A. J. Wood, B. F. Wollenberg, Power generation, operation and control. John Wiley & sons, Inc. New York, 1996, pp. 453-512.
- [37] R. F. Nuqui and A. G. Phadke, "Hybrid Linear State Estimation Utilizing Synchronized Phasor Measurements", Conference Publications Power Tech, 2007 IEEE Lausanne 1-5 July 2007, pp. 1665 - 1669.

# 7.

## CONCLUSION

---

Work under the PRSP included an extensive effort by CAISO, IPC, Peak Reliability, SCE, SDGE, and V&R Energy to coordinate the efforts related to improving PMU data quality in the Western Interconnection.

The PRSP effort led to enhancing PMU/State Estimator mapping, enhancing conventional State Estimator modeling, and improved PMU data quality at the PRSP participants.

From Idaho Power Co. Quarterly PRSP Project Status Report for 2017Q1:

“A significant effort is being made by IPC to validate PMU data and place it in a reliable storage system. The data quality and reliability has improved dramatically [during PRSP]”.

Under the PRSP, V&R Energy is demonstrating a multi-stage process for PMU bad data detection and conditioning using data from CAISO, IPC, Peak Reliability, SCE, and SDGE.

A fast topological approach was also demonstrated under the PRSP to analyze the observability of the power system network and identify optimal PMU locations. The approach is based on automated iterative process of forming decision variables and constraints of a binary integer programming problem, and solving them with standard linear programming solvers. The approach was tested using IPC data. The proposed solution allows us to decrease the number of PMU installations approximately by 42 PMUs compared to convention techniques.

The power flow cases created using the LSE may be used as the backup of the conventional state estimator if results of conventional state estimation become unavailable.

PRSP effort also concentrated on the enhancements to Peak-ROSE as defined in the PRSP Project Plan.

As a part of PRSP activities, Peak-ROSE with the above enhancements was delivered, installed, integrated and tested at IPC, SCE, and SDGE.

Two additional applications were delivered to PRSP participants during the project: WSMViewer and PMU Viewer.

**Appendix E.**  
**Quarterly Peak Reliability Synchrophasor Program (PRSP)**  
**Project Status Reports**

This page left blank intentionally.



## Quarterly PRSP Project Status

**Due: 1<sup>st</sup> week after quarter-end**

<b>Participant Name:</b>	<i>Idaho Power Co.</i>	<b>Report For:</b>	<i>Quarter 3, 2016</i>
<b>Project Manager:</b> <b>PM Phone Number:</b>	<i>Guy Colpron</i> <i>208-388-2784</i>	<b>Date Submitted:</b>	
<b>Budget Forecast to Date:</b>	<i>\$200,000</i>	<b>Actuals to Date:</b>	<i>\$255,933.80</i>
<b>Key Accomplishments or Milestones:</b>	<ul style="list-style-type: none"> <li><i>The new PI PMU server system specially purchased to store PMU data has been installed and is now string the PMU data.</i></li> <li><i>The control design for the installation of (5) new PMUs and (1) PDC is complete. The new PDC has been installed and is operational.</i></li> </ul>		
<b>Upcoming Activities:</b> (Include key future activities both technical and management related.)	<ol style="list-style-type: none"> <li><i>The On-Line version of the ROSE program will need to be matched with the PMU data defined in the IPCo scenarios.</i></li> <li><i>The (3) IPCo scenarios will need to be re-evaluated as to their appropriateness for the current IPCo power system. We expect that minor changes to the scenarios will be required.</i></li> <li><i>The ROSE program output needs to be evaluated.</i></li> <li><i>The installation of the Linear state Estimator.</i></li> <li><i>Continue to correct PMU/PDC data errors.</i></li> </ol>		
<b>Changes to Plan:</b> (Include Scope, approach, and Resource changes)	<ul style="list-style-type: none"> <li><i>No changes to the plan are anticipated at this point.</i></li> </ul>		
<b>Significant Problems/Risks:</b>	<ul style="list-style-type: none"> <li><i>As PMU, PDC, and database information is being reviewed additional errors are being discovered. This will impact the performance of the ROSE/LSE programs.</i></li> <li><i>Peak RC has changed Bus/Node numbers in the WSM base case which then has a ripple effect concerning the PMU mapping files to the WSM base case.</i></li> </ul>		
<b>Miscellaneous:</b>	<ul style="list-style-type: none"> <li><i>A significant effort is being made by IPCo to validate PMU data and place it in a reliable storage system.</i></li> </ul>		

### PRSP Contacts:

*Jeanne Bullion – PRSP Program Manager*  
360-213-2349  
[jbullion@peakrc.com](mailto:jbullion@peakrc.com)

*Kenneth Young – PRSP Grant Accountant*  
360-213-2323  
[kyoung@peakrc.com](mailto:kyoung@peakrc.com)

*Marianna Vaiman – V&R Energy*  
310-979-5966  
[marvaiman@vrenergy.com](mailto:marvaiman@vrenergy.com)



**PEAKRELIABILITY**  
assuring the wide area view

**Peak Reliability Synchrophasor Program**  
**Pre-Commercial Synchrophasor R&D**  
**DE-FOA-0000970**



## Quarterly PRSP Project Status

**Due: 1<sup>st</sup> week after quarter-end**

<b>Participant Name:</b>	<i>Idaho Power Co.</i>	<b>Report For:</b>	<i>Quarter 4, 2016</i>
<b>Project Manager:</b> <b>PM Phone Number:</b>	<i>Guy Colpron</i> <i>208-388-2784</i>	<b>Date Submitted:</b>	
<b>Budget Forecast to Date:</b>	<i>\$200,000</i>	<b>Actuals to Date:</b>	<i>\$258,255.71</i>
<b>Key Accomplishments or Milestones:</b>	<ul style="list-style-type: none"> <li>• <i>The new PI PMU server system specially purchased to store PMU data has been installed and is now string the PMU data.</i></li> <li>• <i>The control design for the installation of (5) new PMUs and (1) PDC is complete. The new PDC has been installed and is operational.</i></li> </ul>		
<b>Upcoming Activities:</b> (Include key future activities both technical and management related.)	<ol style="list-style-type: none"> <li>1. The On-Line version of the ROSE program will need to be matched with the PMU data defined in the IPCo scenarios.</li> <li>2. The (3) IPCo scenarios will need to be re-evaluated as to their appropriateness for the current IPCo power system. We expect that minor changes to the scenarios will be required.</li> <li>3. The ROSE program output needs to be evaluated.</li> <li>4. The installation of the Linear state Estimator.</li> <li>5. Continue to correct PMU/PDC data errors.</li> </ol>		
<b>Changes to Plan:</b> (Include Scope, approach, and Resource changes)	<ul style="list-style-type: none"> <li>• No changes to the plan are anticipated at this point.</li> </ul>		
<b>Significant Problems/Risks:</b>	<ul style="list-style-type: none"> <li>• As PMU, PDC, and database information is being reviewed additional errors are being discovered. This will impact the performance of the ROSE/LSE programs.</li> <li>• Peak RC has changed Bus/Node numbers in the WSM base case which then has a ripple effect concerning the PMU mapping files to the WSM base case.</li> </ul>		
<b>Miscellaneous:</b>	<ul style="list-style-type: none"> <li>• A significant effort is being made by IPCo to validate PMU data and place it in a reliable storage system.</li> <li>• The new updated 2016 version of ROSE was recently installed on IPCo computers.</li> </ul>		

**PRSP Contacts:**

*Jeanne Bullion – PRSP Program Manager*  
 360-213-2349  
[jbullion@peakrc.com](mailto:jbullion@peakrc.com)

*Kenneth Young – PRSP Grant Accountant*  
 360-213-2323  
[kyoung@peakrc.com](mailto:kyoung@peakrc.com)

*Marianna Vaiman – V&R Energy*



**PEAKRELIABILITY**  
assuring the wide area view

**Peak Reliability Synchrophasor Program**  
**Pre-Commercial Synchrophasor R&D**  
**DE-FOA-0000970**

310-979-5966

[marvaiman@vrenergy.com](mailto:marvaiman@vrenergy.com)





## Quarterly PRSP Project Status

**Due: 1<sup>st</sup> week after quarter-end**

<b>Participant Name:</b>	<i>Idaho Power Co.</i>	<b>Report For:</b>	<i>Quarter 1, 2017</i>
<b>Project Manager:</b> <b>PM Phone Number:</b>	<i>Guy Colpron</i> <i>208-388-2784</i>	<b>Date Submitted:</b>	<i>April 20<sup>th</sup>, 2017</i>
<b>Budget Forecast to Date:</b>	<i>\$200,000</i>	<b>Actuals to Date:</b>	<i>\$272,007.40</i>
<b>Key Accomplishments or Milestones:</b>	<ul style="list-style-type: none"> <li><i>The new PI PMU server system specially purchased to store PMU data has been installed and is now string the PMU data.</i></li> <li><i>The control design for the installation of (5) new PMUs and (1) PDC is complete. The new PDC has been installed and is operational.</i></li> </ul>		
<b>Upcoming Activities:</b> (Include key future activities both technical and management related.)	<ol style="list-style-type: none"> <li><i>The On-Line version of the ROSE program will need to be matched with the PMU data defined in the IPCo scenarios.</i></li> <li><i>The (3) IPCo scenarios will need to be re-evaluated as to their appropriateness for the current IPCo power system. We expect that minor changes to the scenarios will be required.</i></li> <li><i>The ROSE program output needs to be evaluated.</i></li> <li><i>The installation of the Linear state Estimator.</i></li> <li><i>Continue to correct PMU/PDC data errors.</i></li> </ol>		
<b>Changes to Plan:</b> (Include Scope, approach, and Resource changes)	<ul style="list-style-type: none"> <li><i>No changes to the plan are anticipated at this point.</i></li> </ul>		
<b>Significant Problems/Risks:</b>	<ul style="list-style-type: none"> <li><i>Peak RC and IPCo Operations Group has changed Bus/Node numbers in the WSM base case which then has a ripple effect concerning the PMU mapping files to the WSM base case.</i></li> <li><i>Server updates and patches continue to impact the On-Line ROSE program.</i></li> </ul>		
<b>Miscellaneous:</b>	<ul style="list-style-type: none"> <li><i>A significant effort is being made by IPCo to validate PMU data and place it in a reliable storage system. The data quality and reliability has improved dramatically.</i></li> <li><i>The new updated 2016 version of ROSE was recently installed on IPCo server and Planning computers.</i></li> </ul>		

### PRSP Contacts:

*Jeanne Bullion – PRSP Program Manager*  
360-213-2349  
[jbullion@peakrc.com](mailto:jbullion@peakrc.com)

*Kenneth Young – PRSP Grant Accountant*  
360-213-2323  
[kyoung@peakrc.com](mailto:kyoung@peakrc.com)



**PEAKRELIABILITY**  
assuring the wide area view

**Peak Reliability Synchrophasor Program**  
**Pre-Commercial Synchrophasor R&D**  
**DE-FOA-0000970**

*Marianna Vaiman – V&R Energy*  
310-979-5966  
[marvaiman@vrenergy.com](mailto:marvaiman@vrenergy.com)